



1989

BMW 325iX

Electrical

Troubleshooting

Manual

**BMW of North America, Inc.
Woodcliff Lake, New Jersey**

FOREWORD

In the interests of continuing technical development work we reserve the right to modify designs and equipment.

Printed in USA

©Copyright BMW of North America, Inc.

Not to be reproduced wholly or in part without written permission of BMW of North America, Inc.

PN 89 89 1 000 294

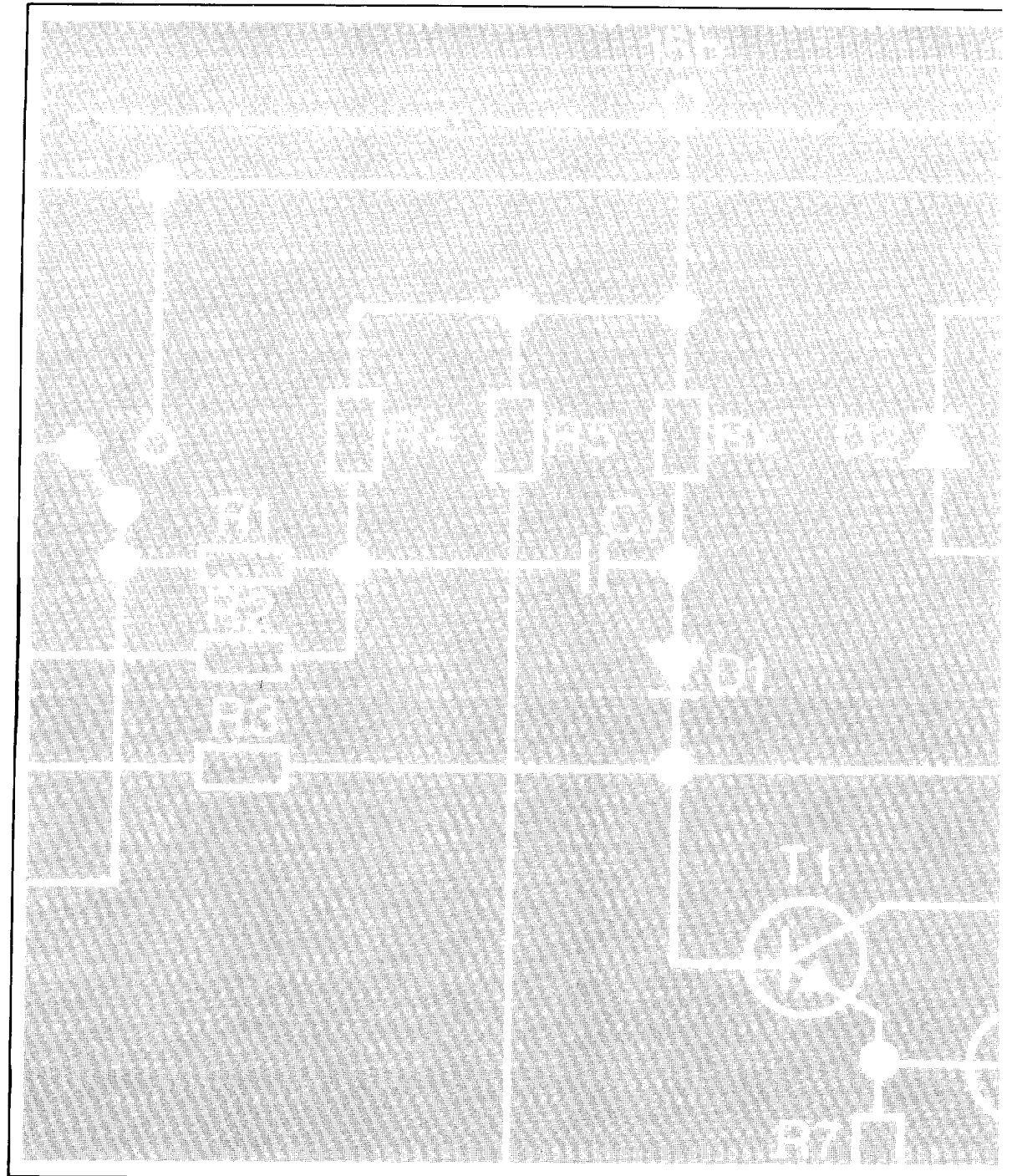

**1989
BMW 325iX
Electrical
Troubleshooting
Manual**

CONTENTS

Index	2
How To Use This Manual	3
Wire Size Conversion Chart	3
Symbols	4
Systematic Troubleshooting	6
Connector Views	8500-0
Power Distribution Box	0670-0
Fuse Data	0670-1
Component Location Chart	9000-0
Component Location Views	7000-0
Splice Location Views	8000-0

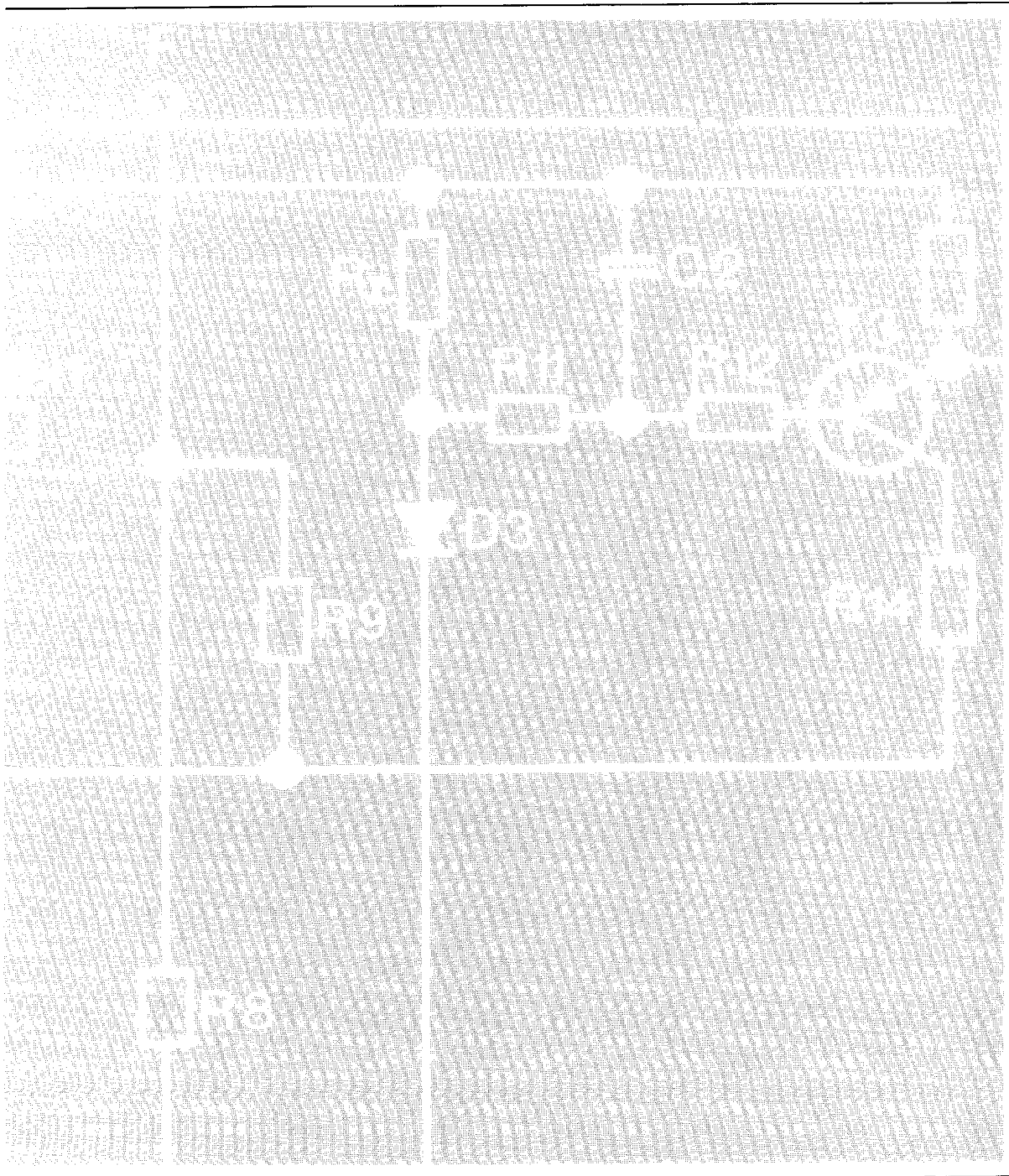

Index – Alphabetical Listing of Electrical Circuits

	PAGE		PAGE		PAGE
Active Check Control	6216-0		0670-14	– Fog	6312-0
A/C Air Delivery Control	6421-0		0670-15	– Front Ashtray	6300-1
A/C Blower Controls	6413-0		0670-16	– Front Side Marker	6314-0
A/C Compressor Controls	6452-0	– G201	0670-15	– Front Turn/Park	6314-0
A/C Temperature Control	6411-0	– G300	0670-17	– Glove Box	6100-1
Antilock Braking System (ABS)	3450-0	– G302	0670-16	– Hazard Switch	6313-0
Auto-Charging Flashlight	6100-1	Heated Seats	5200-0	– Headlights	6312-0
Auxiliary Fan	6454-0	Horns	6100-0	– Instrument Cluster	6300-1
Auxiliary Fuse	0670-2	Ignition Key Warning	6131-0	– Interior	6330-0
Brake Warning System	3435-0	Indicators		– License	6320-0
Central Locking, 2 Door	5126-0	– Active Check Control Alarm	6210-1	– Map Reading Light	6100-1
Central Locking, 4 Door	5126-2	– Anti-Lock	3450-0	– Park	6314-0
Charge	1230-0	– “Brake Lights” Fault	6216-1	– Rear Side Marker	6320-0
Cigar Lighter	6100-1	– “Brake Lining” Wear	3435-0	– Stop	6325-0
Component Location Chart	9000-0	– “Brake” Warning	3435-0	– Tail	6314-0
Component Location Views	7000-0	– Charge	6210-0	– Trunk	6320-0
Connector Views	8500-0	– Check Engine	1360-3	– Turn/Hazard	6313-1
Cruise Control	6571-0	– “Coolant” Level Fault	6216-2	Light Switch Details	6300-0
Fuel Economy Gauge	6210-3	– “Engine Oil” Fault	6216-2	Multi-function Clock	6581-0
Fuel Gauge	6210-1	– Fasten Seatbelts	6216-2	Power Antenna	6500-0
Fuse Data Chart	0670-1	– Fog Lights	6312-0	Power Distribution	0670-0
Fuse Details		– High Beam	6312-1	Power Distribution Box	0670-0
– Fuse 4	0670-6	– Inspection	6210-2	Power Mirrors	5116-0
– Fuse 5	0670-6	– LH Turn	6313-1	Power Windows, 2 Door	5133-2
– Fuse 6	0670-6	– “License Plate” Fault	6320-0	Power Windows, 4 Door	5133-0
– Fuse 8	0670-7	– “Low Beam” Fault	6216-0	Radio Without Sound System	6500-0
– Fuse 9	0670-11	– Low Fuel Warning	6210-1	Rear Defogger	6100-2
– Fuse 10	0670-8	– Oil Pressure Warning	6210-1	Seatbelt Warning	6131-0
– Fuse 12	0670-7	– Oil Service	6210-2	Service Interval Indicator	6210-2
– Fuse 19	0670-7	– “Park Brake”	3435-0	Speedometer	6210-0
– Fuse 20	0670-9	– “Rear Lights” Fault	6314-0	Splice Location Views Index	8000-0
– Fuse 21	0670-10	– RH Turn	6313-1	Start, Automatic Transmission	1240-0
– Fuse 27	0670-11	– “Washer Fluid” Fault	6216-2	Start, Manual Transmission	1240-1
Gauges	6210-1	Injection Electronics	1360-0	Tachometer	6210-3
Ground Distribution		Instrument Cluster	6210-0	Temperature Gauge	6210-1
– G103	0670-12	Lights		Warnings	
– G104	0670-13	– A/C Control Power	6300-1	– Ignition Key/Seatbelt	6131-0
– G200	0670-13	– Back Up	6322-0	Wiper/Washer	6160-0

The purpose of this manual is to show electrical schematics in a manner that makes electrical troubleshooting easier. Electrical components which work together are shown together on one schematic. The Wiper-Washer schematic, for example, shows all of the electrical components in one diagram. At the top of the page is the fuse (positive) that powers the circuit. The flow of current is shown through all wires, connectors, switches, and motors to ground (negative) at the bottom of the page.

Within the schematic, all switches and sensors are shown "at rest," as though the Ignition Switch were off. For identification, component names are underlined and placed next to or above each component. Notes are included, describing how switches and other components work.

The power distribution schematic shows the current feed through all the connections from the Battery and Alternator to each fuse and the Ignition and Light Switches. If the Power Distribution schematic is combined with any other circuit schematic, a complete picture is made of how that circuit works. The Ground Distribution schematics show how several circuits are connected to common grounds.

All wiring between components is shown exactly as it exists in the vehicle; however, the wiring is not drawn to scale. To aid in understanding electrical operation, wiring inside complicated components has been simplified. The "Solid State" label designates electronic components.

WIRE SIZE CONVERSION CHART	
METRIC (CROSSSECTIONAL AREA IN MM ²)	AWG (AMERICAN WIRE GAUGE)
.5	20
.75	18
1	16
1.5	14
2	14
2.5	12
4	10
6	8
8	8
16	4
20	4
25	2
32	2

WIRE INSULATION	
ABBREVIATIONS	COLOR
BK	BLACK
BR	BROWN
RD	RED
YL	YELLOW
GN	GREEN
BU	BLUE
VI	VIOLET
GY	GRAY
WT	WHITE
PK	PINK

4 SYMBOLS

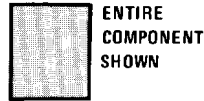

ENTIRE COMPONENT SHOWN

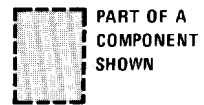

PART OF A COMPONENT SHOWN

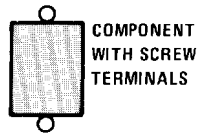

COMPONENT WITH SCREW TERMINALS



SOLID STATE (INCLUDES ONLY ELECTRONIC PARTS)

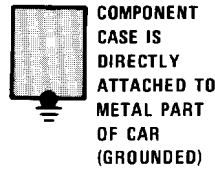

COMPONENT CASE IS DIRECTLY ATTACHED TO METAL PART OF CAR (GROUNDED)

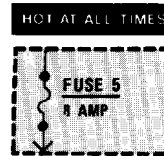

INDICATES THAT FUSE 5 IS ALWAYS SUPPLIED WITH POWER

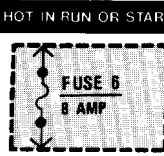

INDICATES THAT FUSE 6 IS SUPPLIED WITH POWER WITH THE IGNITION SWITCH IN THE RUN OR START POSITIONS

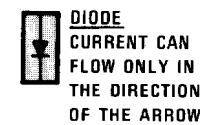
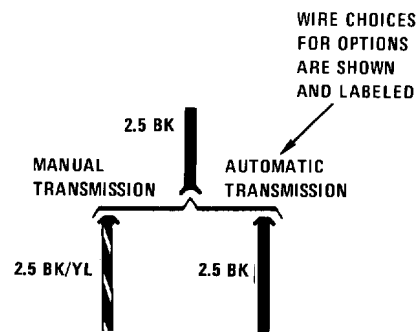
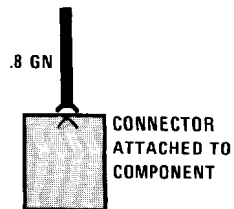
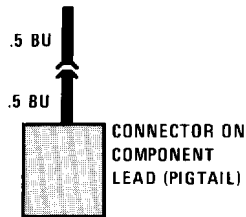
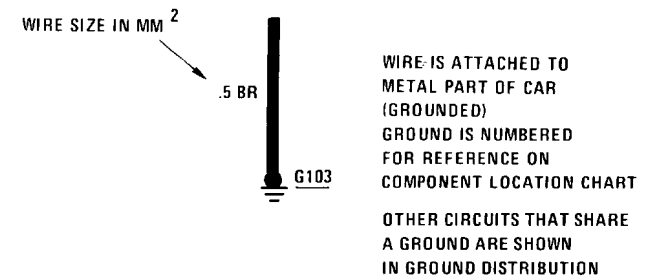
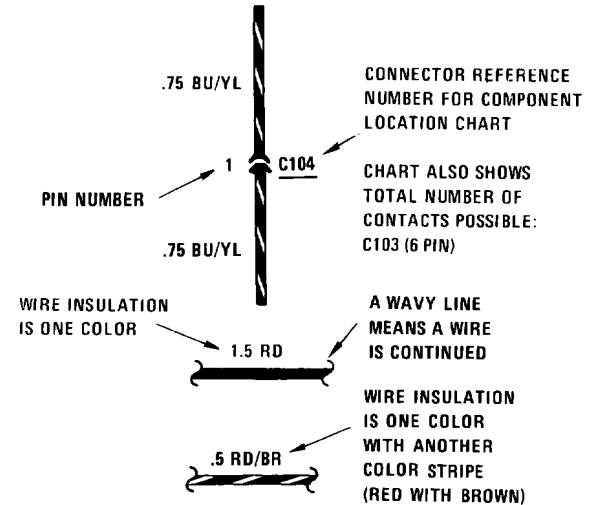

CIRCUIT REFERENCE - A WIRE WHICH CONNECTS TO ANOTHER CIRCUIT

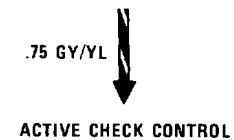

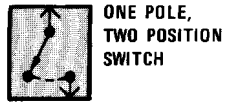

**ONE POLE,
TWO POSITION
SWITCH**

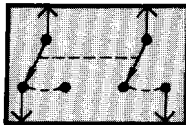

**SWITCHES THAT
MOVE TOGETHER**

DASHED LINE SHOWS
A MECHANICAL
CONNECTION
BETWEEN SWITCHES

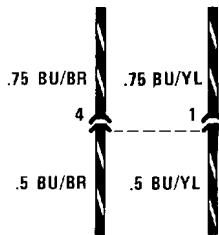

**TWO CONNECTIONS
(PINS) IN THE SAME
CONNECTOR**

DASHED LINE SHOWS
PARTS OF THE
SAME CONNECTOR

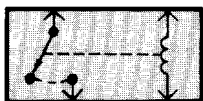

**WHEN COIL IS
ENERGIZED, SWITCH
IS PULLED CLOSED**

**RELAY SHOWN
WITH NO
CURRENT
FLOWING
THROUGH
COIL**

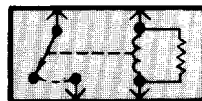

**RELAY SHOWN
WITH RESISTOR
ACROSS COIL**

RESISTOR ACROSS COIL
IS FOR NOISE
SUPPRESSION

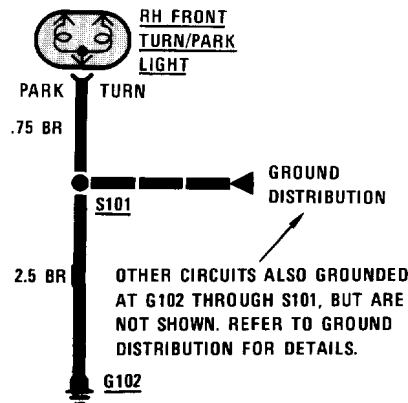

**OTHER CIRCUITS ALSO GROUNDED
AT G102 THROUGH S101, BUT ARE
NOT SHOWN. REFER TO GROUND
DISTRIBUTION FOR DETAILS.**



**LIGHT
EMITTING
DIODE**

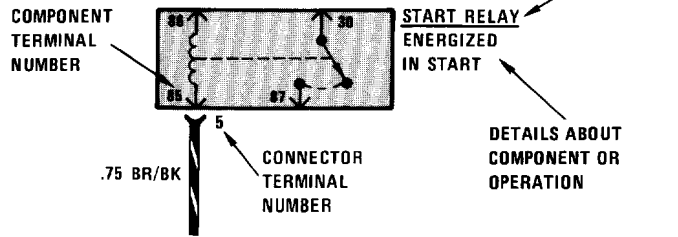

**DETAILS ABOUT
COMPONENT OR
OPERATION**

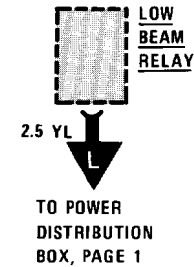

**CURRENT PATH
IS CONTINUED
AS LABELED.
THE ARROW SHOWS
DIRECTION OF CURRENT
FLOW AND IS REPEATED
WHERE CURRENT
PATH CONTINUES.**

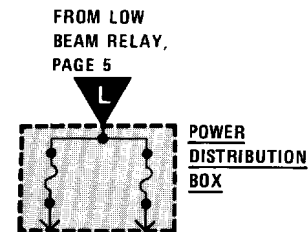
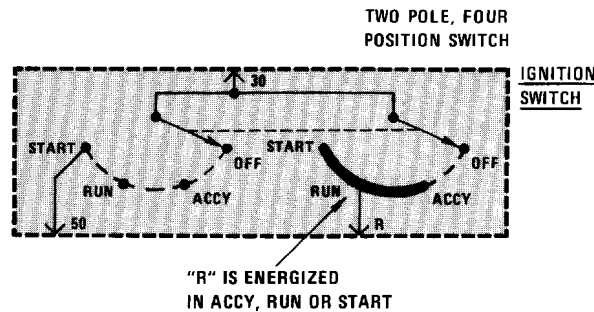

6 SYSTEMATIC TROUBLESHOOTING

TROUBLESHOOTING PROCEDURE

1. Verify the Problem

Operate the problem circuit to check the accuracy of the complaint. Note the symptoms of the inoperative circuit.

2. Analyze the Problem

Refer to the schematic of the problem circuit in the ETM. Determine how the circuit is supposed to work by tracing the current path(s) from the power feed through the circuit components to ground. Then based on the symptoms you noted in step 1 and your understanding of circuit operation, identify one or more possible causes of the problem.

3. Isolate the Problem

Make circuit tests to prove or disprove the preliminary diagnosis made in step 2. Keep in mind that a logical simple procedure is the key to efficient troubleshooting. Test for the most likely cause of failure first. Try to make tests at points which are easily accessible.

4. Repair the Problem

Once the specific problem is identified, make the repair using the proper tools and safe procedures.

5. Check the Problem

Operate the circuit to check for satisfactory circuit operation. Good repair practice calls for rechecking all circuits you have worked on.

TROUBLESHOOTING TOOLS

Isolating the problem (Step 3 of TROUBLESHOOTING PROCEDURES) requires the use of a **voltmeter** and/or **ohmmeter**. A voltmeter measures voltage at selected points in a circuit. An ohmmeter measures a circuit's resistance to current flow. It has an internal battery that provides current to the circuit under test. Disconnect the car battery when using an ohmmeter because the battery voltage will cause the ohmmeter to give false readings. Also, do not use an ohmmeter on solid-state components. The voltage that the ohmmeter applies to the circuit could damage these components.

TROUBLESHOOTING TESTS

Voltage Test

This test measures voltage in a circuit. By taking measurements at several points (terminals or connectors) along the circuit, you can isolate the problem.

To take a voltage measurement, connect the negative lead of the voltmeter to the battery's negative terminal or other known good ground. Then connect the positive lead of the voltmeter to the point you want to test. The voltmeter will measure the voltage present at that point in the circuit.

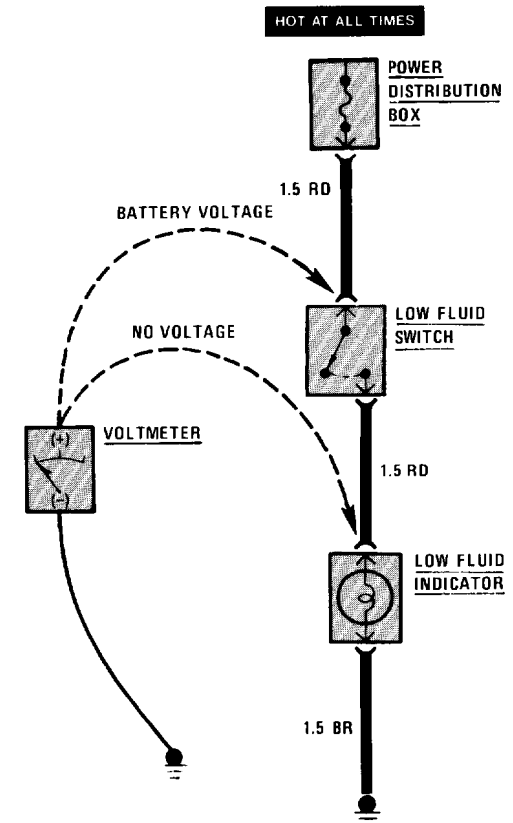

Voltage Test

Voltage Drop Test

Wires, connectors, and switches are designed to conduct current with a minimum loss of voltage. A voltage drop of more than one volt indicates a problem.

To test for voltage drop, connect the voltmeter leads to connectors at either end of the circuit's suspected problem area. The positive lead should be connected to the connector closest to the power source. The voltmeter will show the voltage drop between these two points.

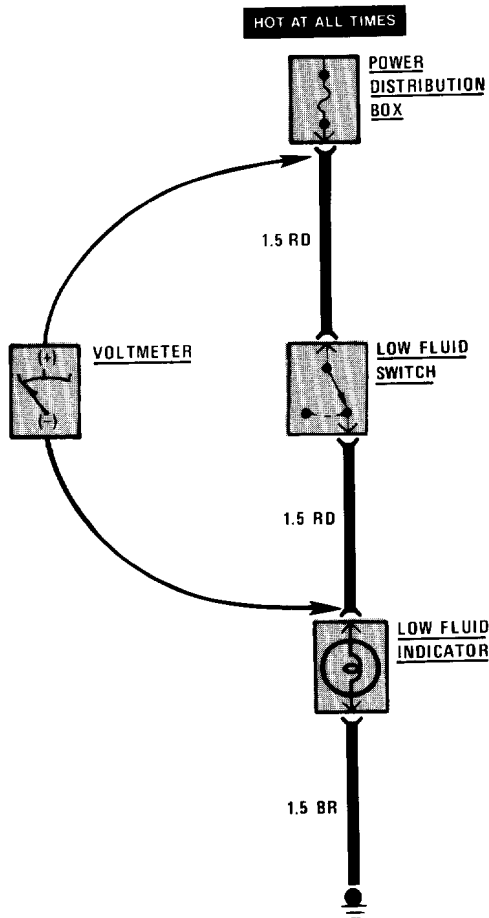

Voltage Drop Test

Continuity Test

To perform a continuity test, first disconnect the car battery. Then adjust the ohmmeter to read zero while holding the leads together. Connect the ohmmeter leads to connector or terminals at either end of the circuit's suspected problem area. The ohmmeter will show the resistance across that part of the circuit.

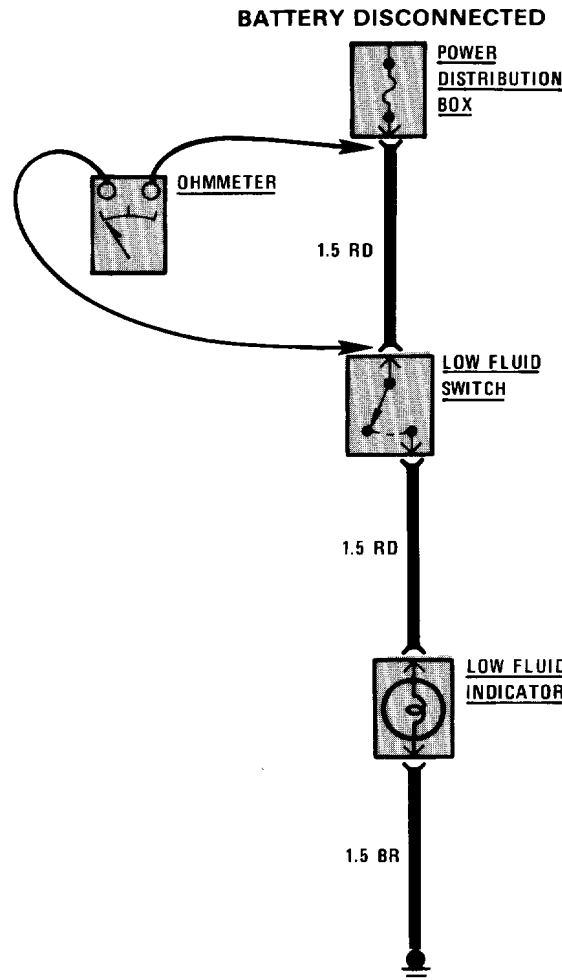

Continuity Test

Short Test Using Voltmeter

Remove the blown fuse and disconnect the load. Connect the voltmeter leads to the fuse terminals. The positive lead should be connected to the terminal closest to the power source.

Starting near the POWER DISTRIBUTION BOX, move the wire harness back and forth and watch the voltmeter reading. If the voltmeter registers a reading, there is a short to ground in the wiring. Somewhere in the area of the harness being moved, the wire insulation is worn away and the circuit is grounding.

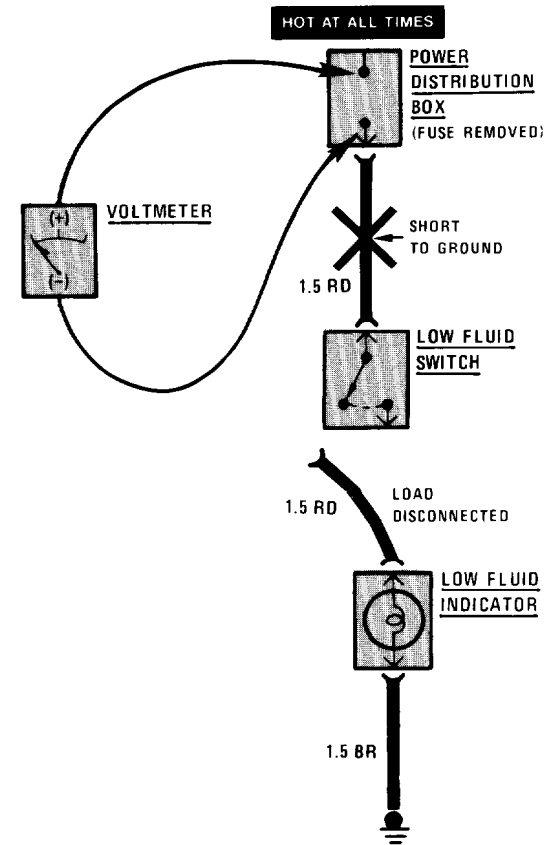

Short Test Using Voltmeter

8 SYSTEMATIC TROUBLESHOOTING

Short Test Using Ohmmeter

Disconnect the battery. Adjust the ohmmeter to read zero while holding the leads together. Remove the blown fuse and disconnect the load. Connect one lead of the ohmmeter to the fuse terminal that is closest to the load. Connect the other lead to the load. Connect the other lead to a known good ground.

Starting near the POWER DISTRIBUTION BOX, move the wire harness back and forth and watch the ohmmeter reading. Low or no resistance indicates a short to ground in the wiring. Infinitely high resistance indicates no short.

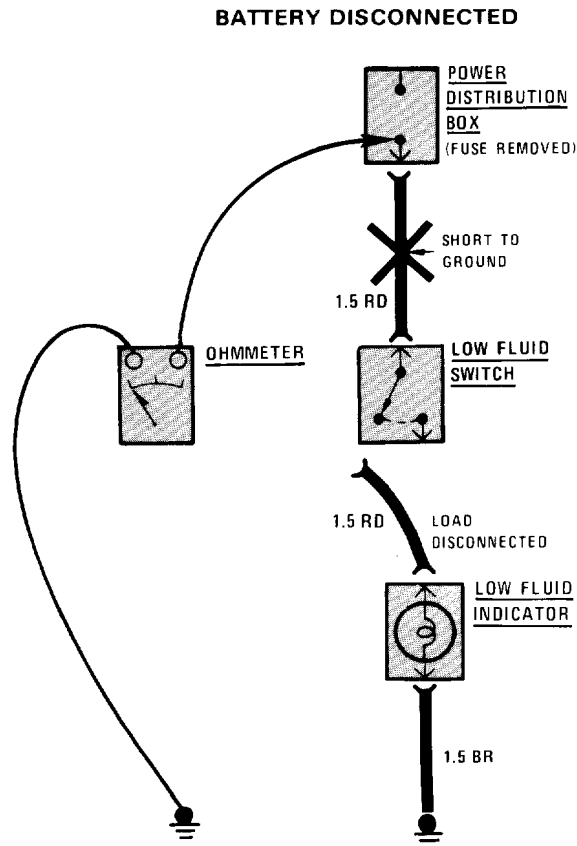

Short Test Using Ohmmeter

0670-0 POWER DISTRIBUTION

POWER DISTRIBUTION BOX

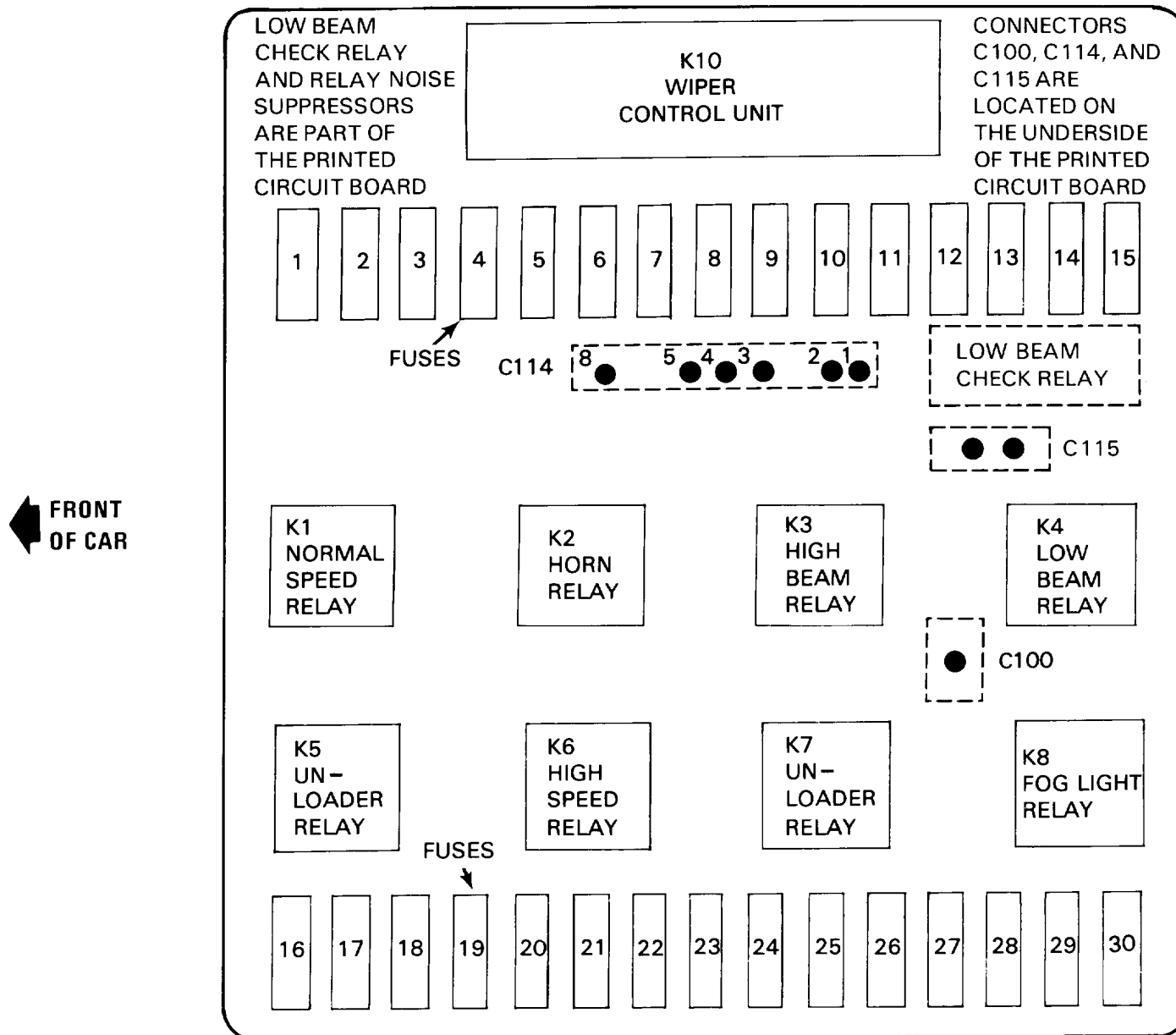

FUSE DATA CHART

FUSE NO.	SIZE/COLOR	CIRCUIT NAME
1	7.5A	Headlights (also fuses 2, 13, 14); High Beam Indicator.
2	7.5A	Headlights (also fuses 1, 13, 14).
3	15A	Auxiliary Fan (also fuses 18, 19, 20).
4	15A	Lights: Turn/Hazard (also fuse 24); Active Check Control (also fuses 6, 10, 21, 22, 23); Glove Box Light.
5	30A	Wiper/Washer.
6	7.5A	Stop Lights; Cruise Control (Also fuse 10); Active Check Control (also fuses 4, 10, 21, 22, 23); Antilock Braking System; Map Reading Light.
7	15A	Horn.
8	30A	Rear Defogger (also fuse 23).
9	15A	Injection Electronics (also fuses 10, 11, 21).
10	7.5A	Seatbelt Warning (also fuse 21); Cruise Control (also fuse 6); Service Interval Indicator (also fuse 21); Tachometer/Fuel Economy Gauges (also fuse 21); Gauges/Indicators; Brake Warning System; Back Up Lights; Start; Active Check Control (also fuses 4, 6, 21, 22, 23). Injection Electronics (also fuse 9, 11, 21);
11	7.5A	Injection Electronics (also fuses 9, 10, 21).
12	7.5A	Radio (also fuses 21, 28); Speedometer/Indicators; Multifunction Clock (also fuses 21, 23).
13	7.5A	Headlights (also fuses 1, 2, 14).
14	7.5A	Headlights (also fuses 1, 2, 13).
15	—	Not Used.
16	15A	Heated Seats.
17	30A	Power Windows.
18	30A	Auxiliary Fan (also fuses 3, 19, 20).
19	7.5A	Auxiliary Fan (also fuses 3, 18, 20); Interior Lights (also fuses 21, 27); Power Mirrors.

FUSE NO.	SIZE/COLOR	CIRCUIT NAME
20	30A	Heater/Air Conditioning; Auxiliary Fan (also fuses 3, 18, 19).
21	7.5A	Auto-Charging Flashlight; Ignition Key Warning/Seatbelt Warning; (also fuse 10); Interior Lights (also fuses 19, 27); Radio (also fuses 12, 28); Trunk Light; Active Check Control (also fuses 4, 6, 10, 22, 23); Service Interval Indicator (also fuse 10); Multifunction Clock (also fuses 12, 23); Injection Electronics (also fuses 9, 10, 11); Tachometer/Fuel Economy Gauge (also fuse 10).
22	7.5A	Active Check Control (also fuses 4, 6, 10, 21, 23); Lights: Front Park/Tail (also fuse 23); Lights: Front Side Marker (also fuse 23).
23	7.5A	Lights: Dash Lights: Front Park/Tail (also fuse 22); Lights: Front Side Marker (also fuse 22); Lights: Rear Marker/License; Active Check Control (also fuses 4, 6, 10, 21, 22); Multifunction Clock (also fuses 12, 21); Rear Defogger (also fuse 8).
24	15A	Lights: Turn/Hazard (also fuse 4).
25	—	Not Used.
26	—	Not Used.
27	30A	Interior Lights (also fuses 19, 21); Central Locking;
28	30A	Cigar Lighter; Radio/Antenna (also fuses 12, 21).
29	7.5A	Fog Lights (also fuse 30); Fog Lights Indicator.
30	7.5A	Fog Lights (also fuse 29).
POWER WINDOW CIRCUIT BREAKER		25A Power Windows

0670-2 POWER DISTRIBUTION

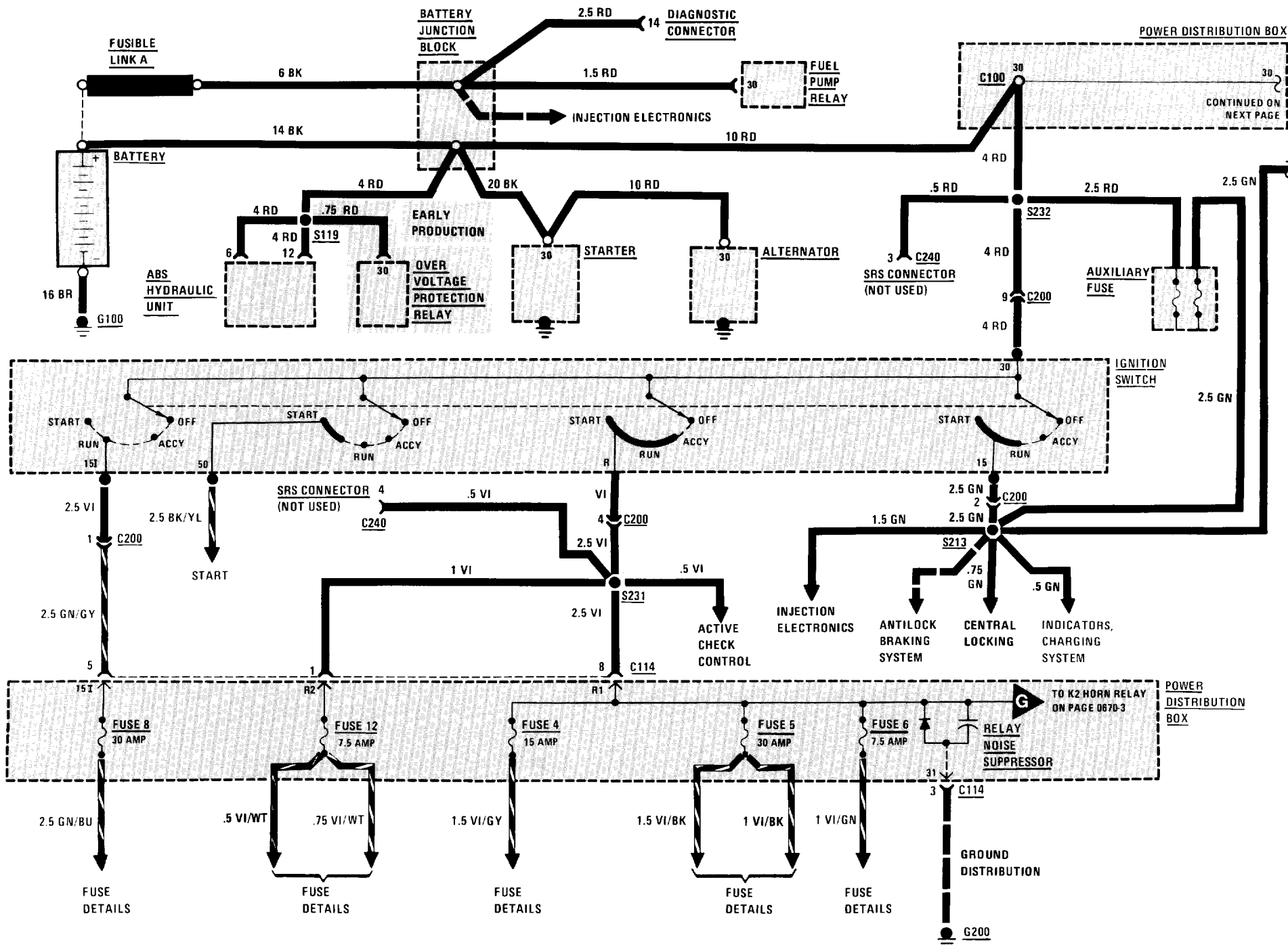

POWER DISTRIBUTION BOX

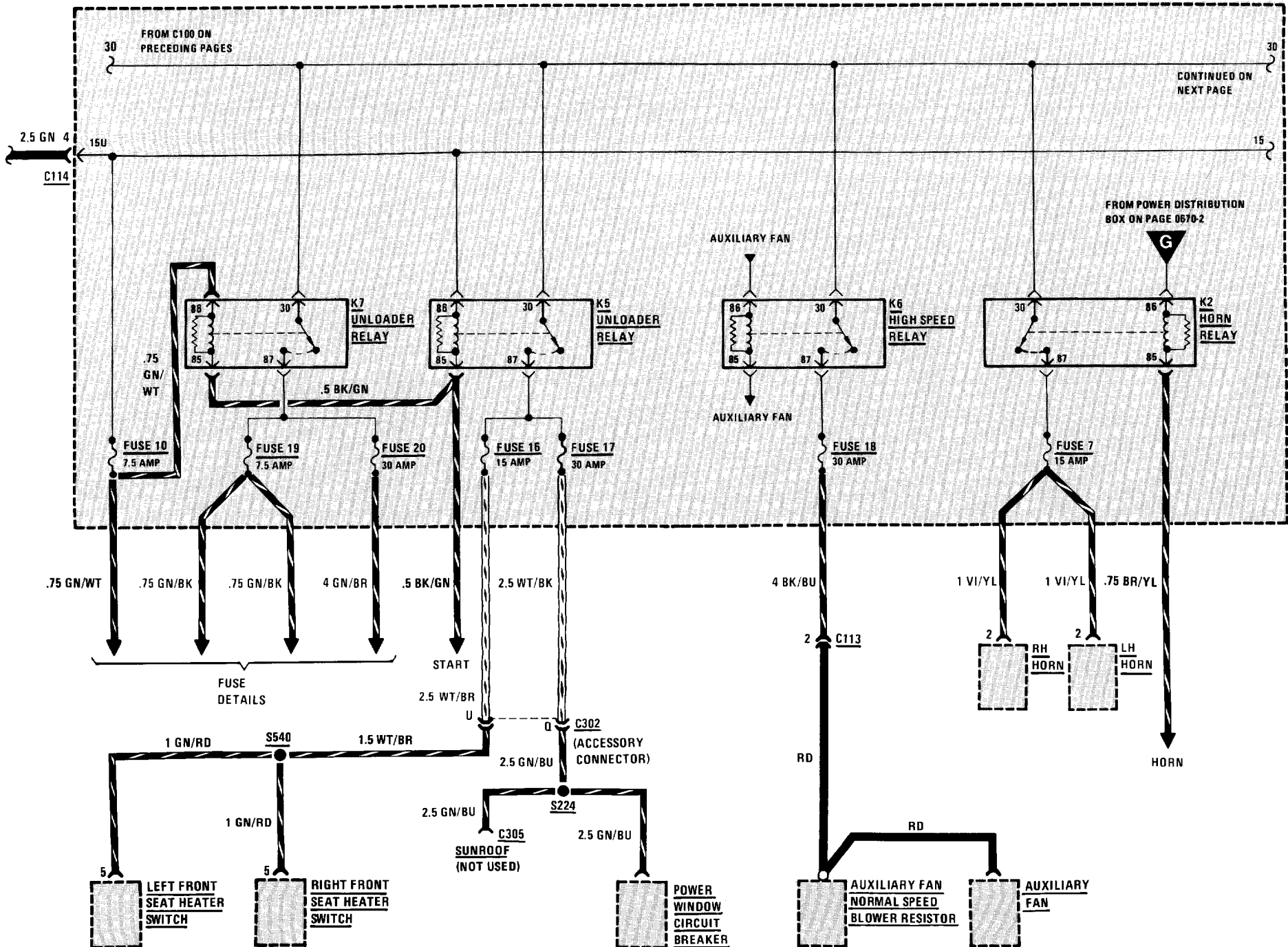

0670-4 POWER DISTRIBUTION

POWER DISTRIBUTION BOX

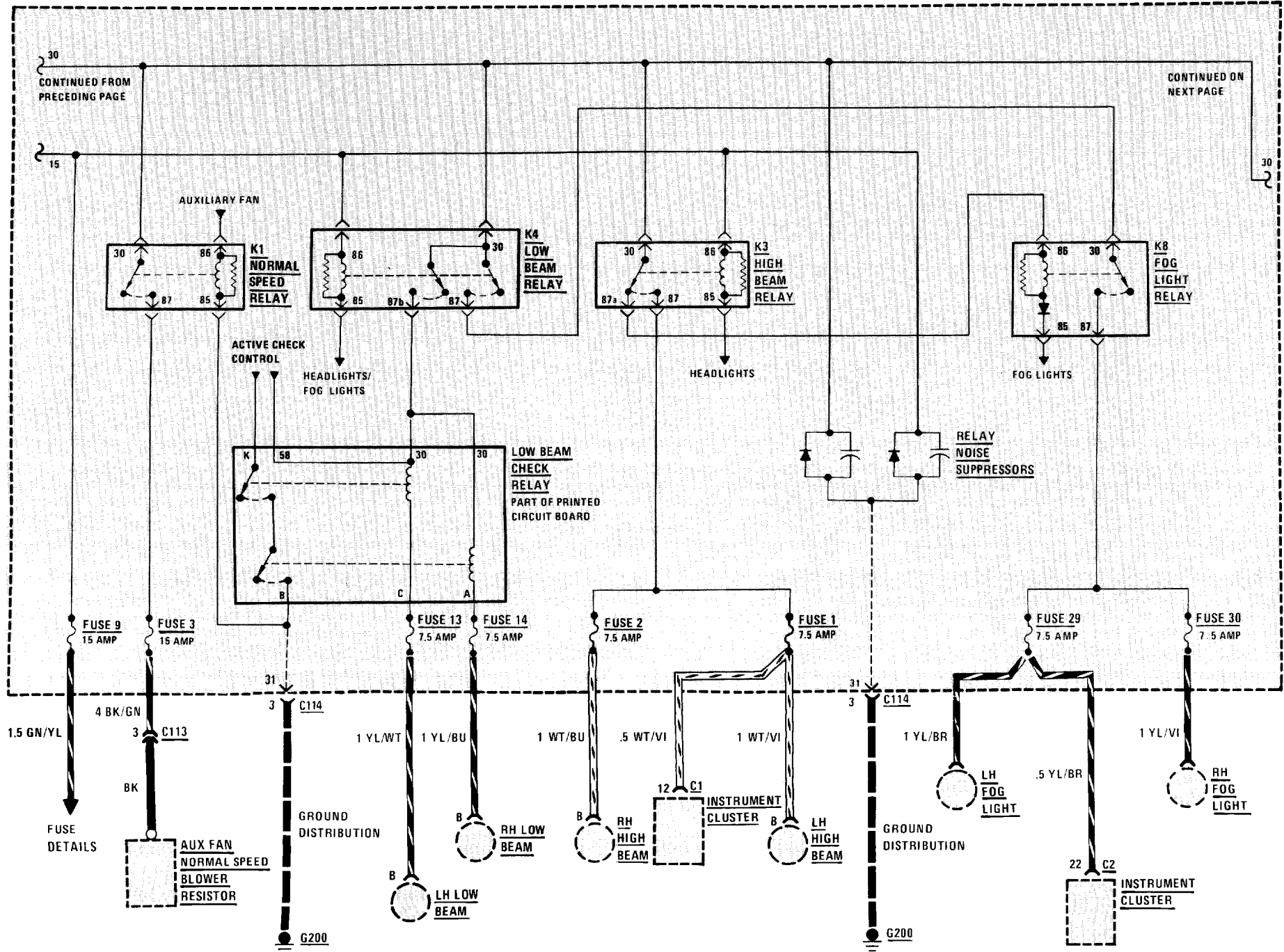

CONTINUED FROM PRECEDING PAGE

CONTINUED ON NEXT PAGE

POWER
DISTRIBUTION
BOX

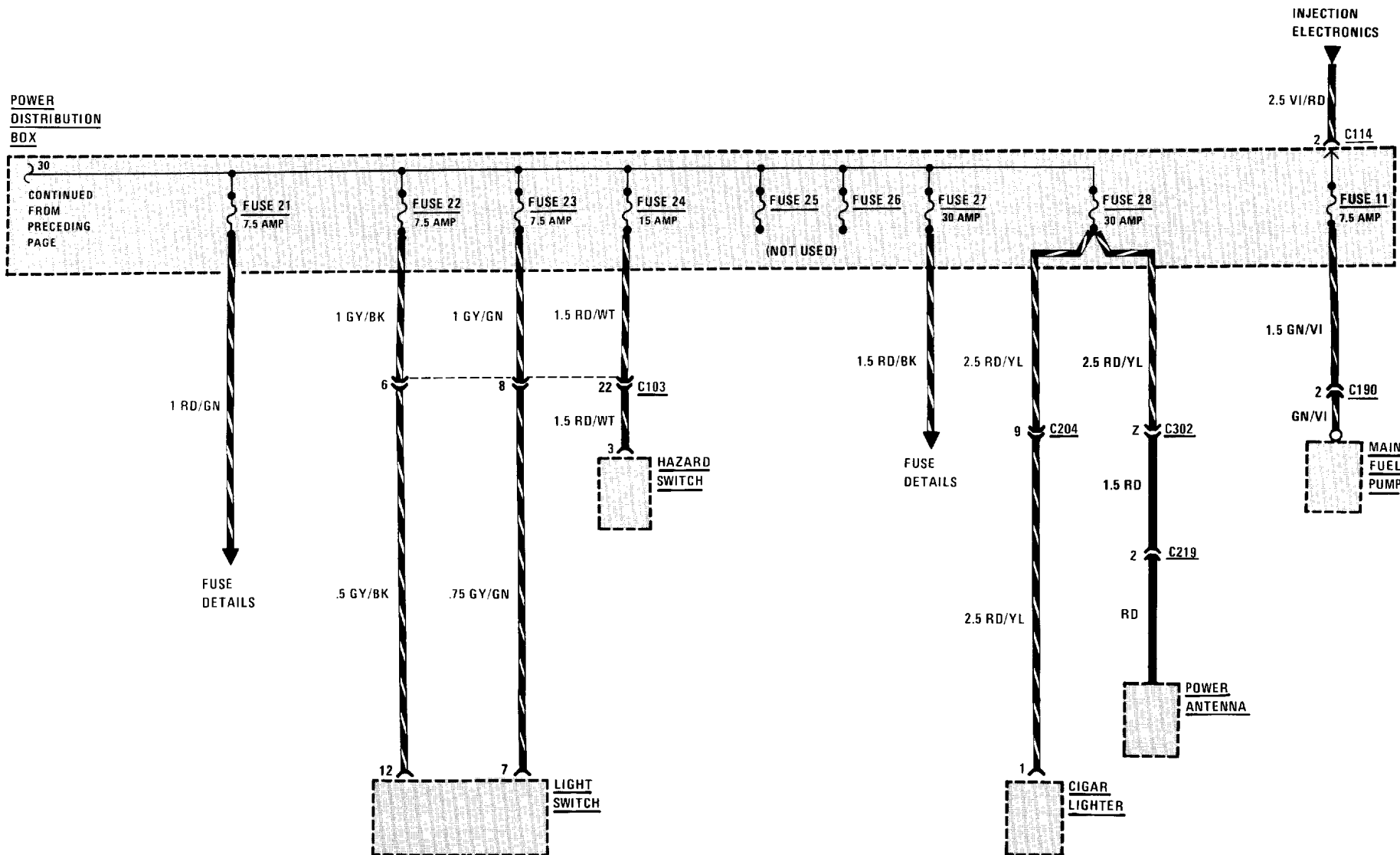

FUSE DETAILS: FUSES 4, 5, AND 6

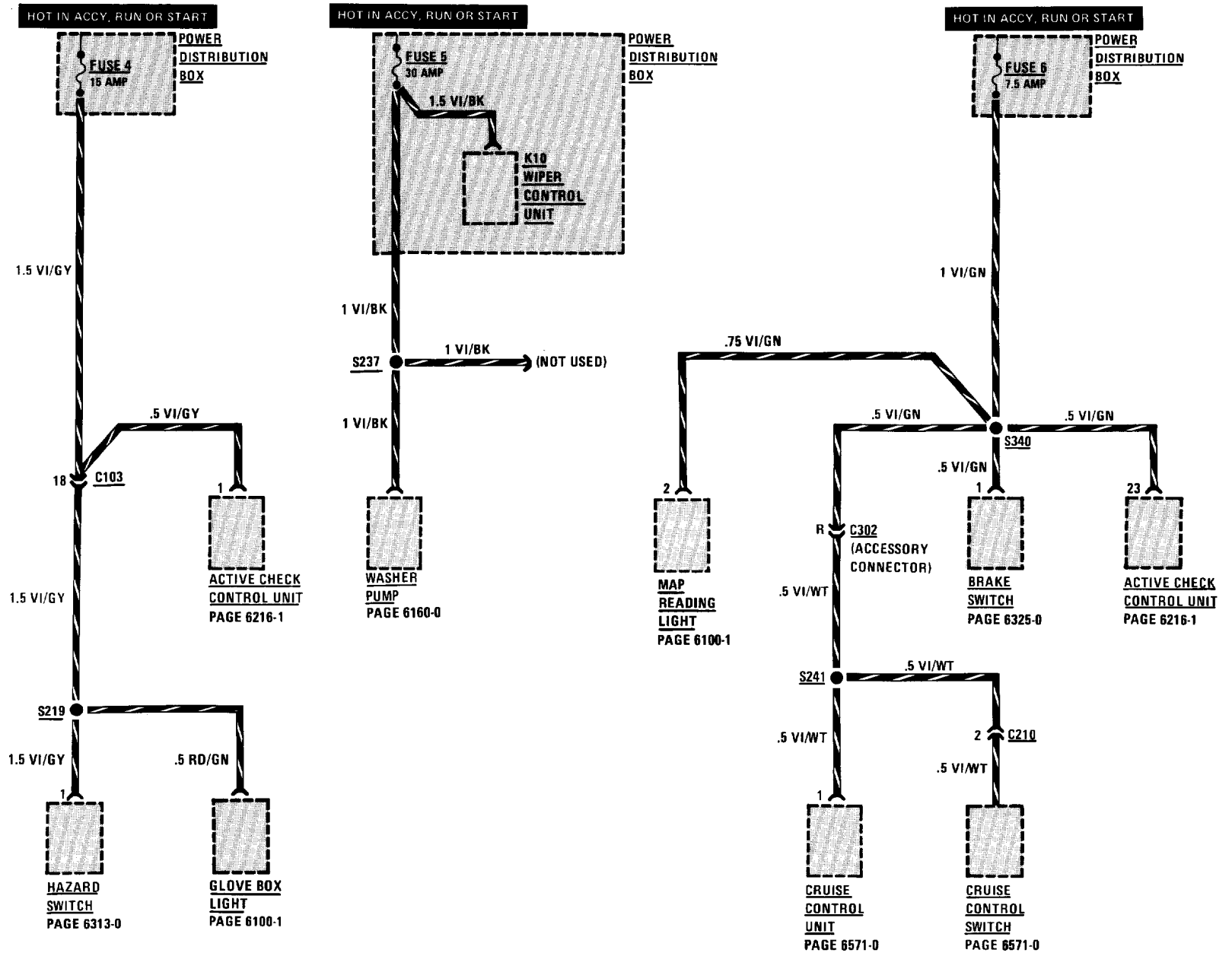

FUSE DETAILS: FUSES 8, 12 AND 19

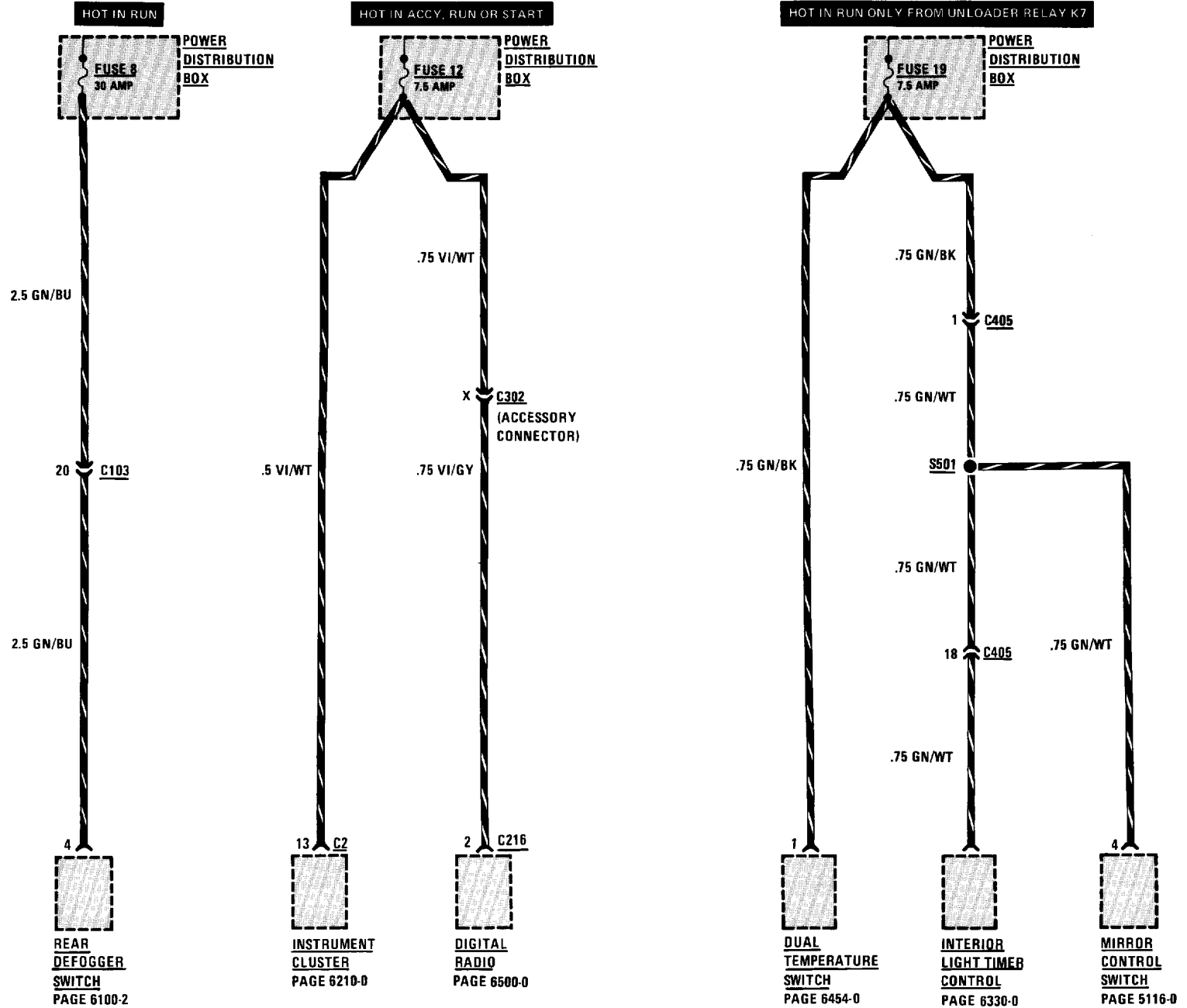

FUSE DETAILS: FUSE 10

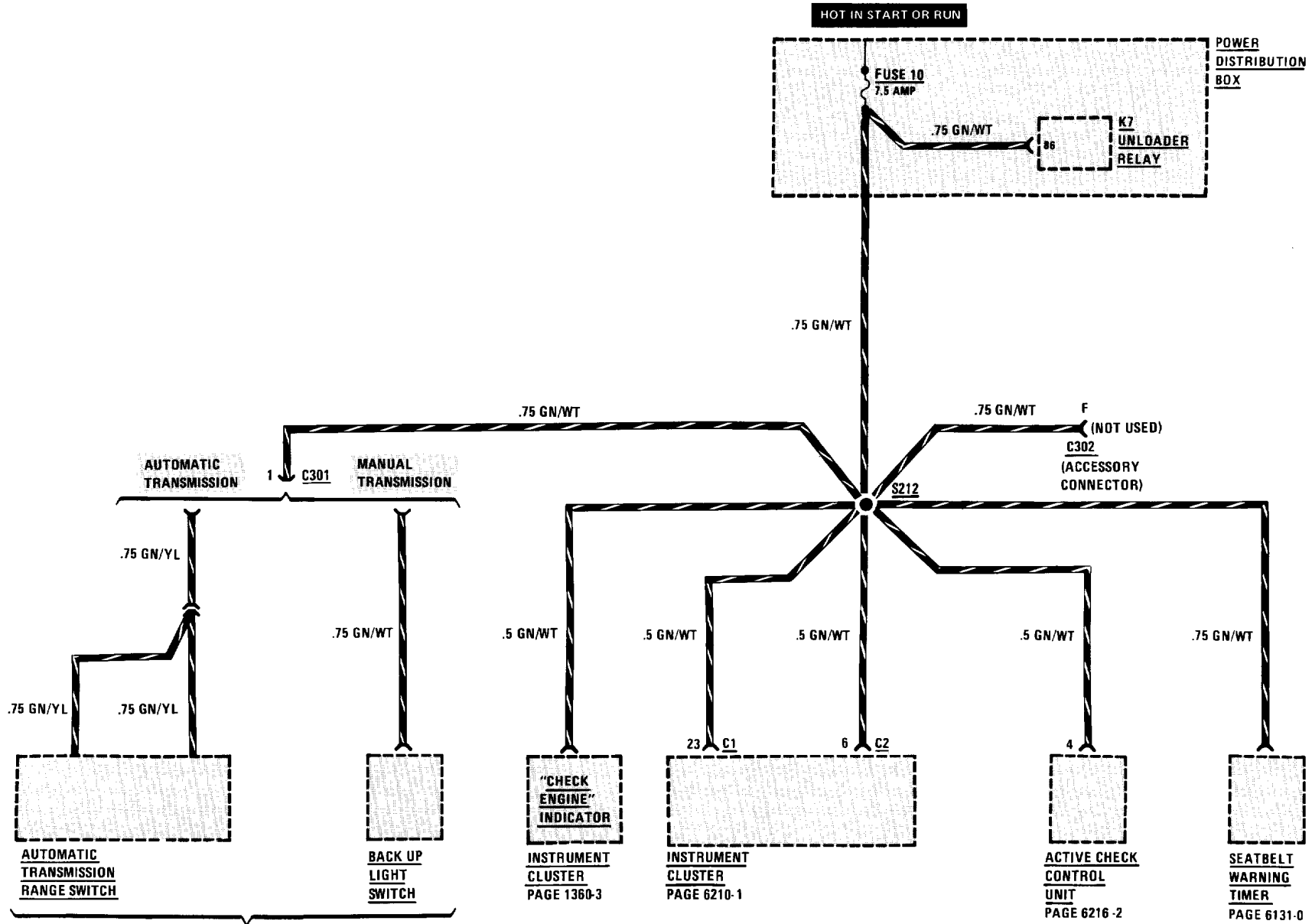

FUSE DETAILS: FUSE 20

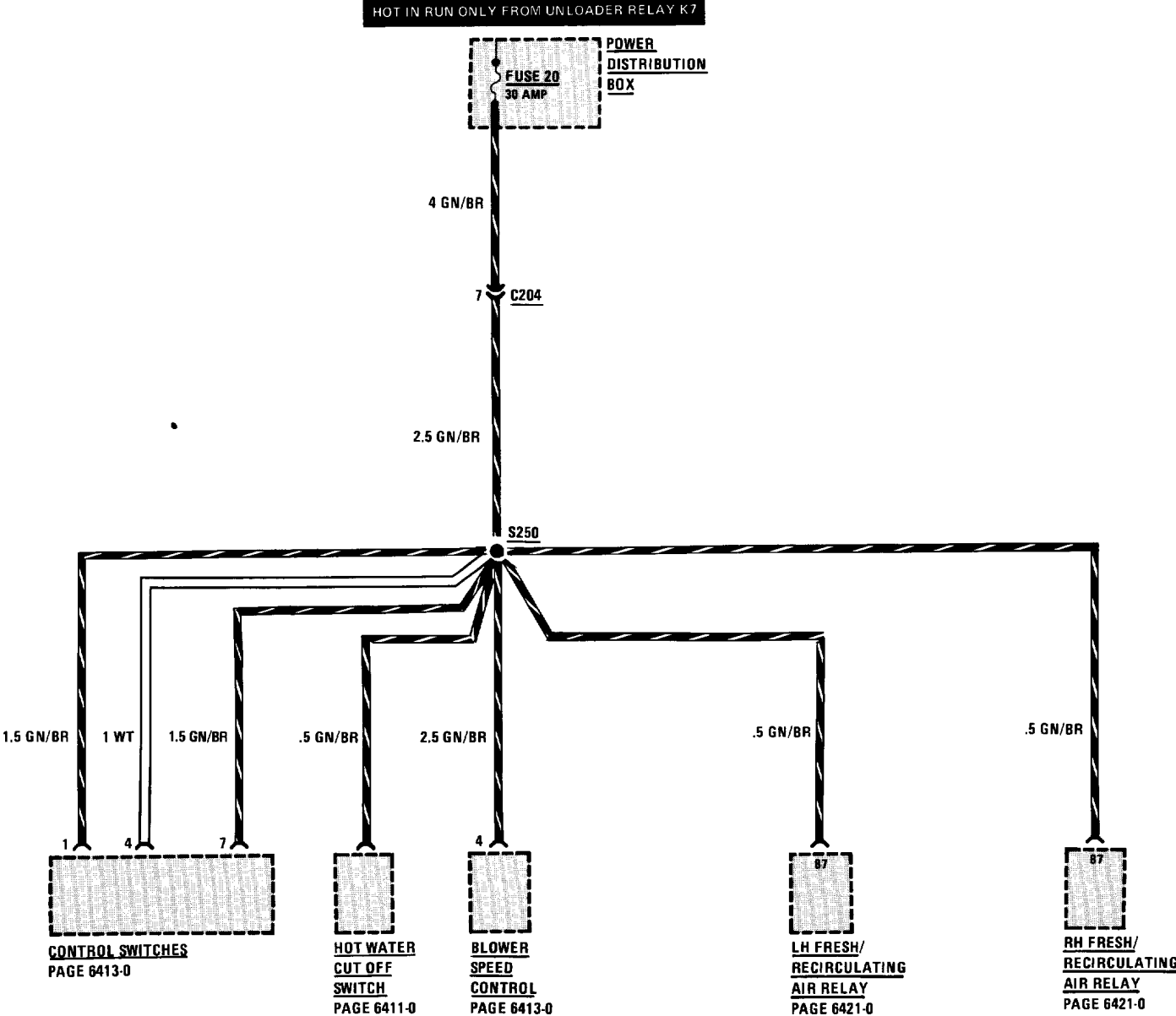

FUSE DETAILS: FUSE 21

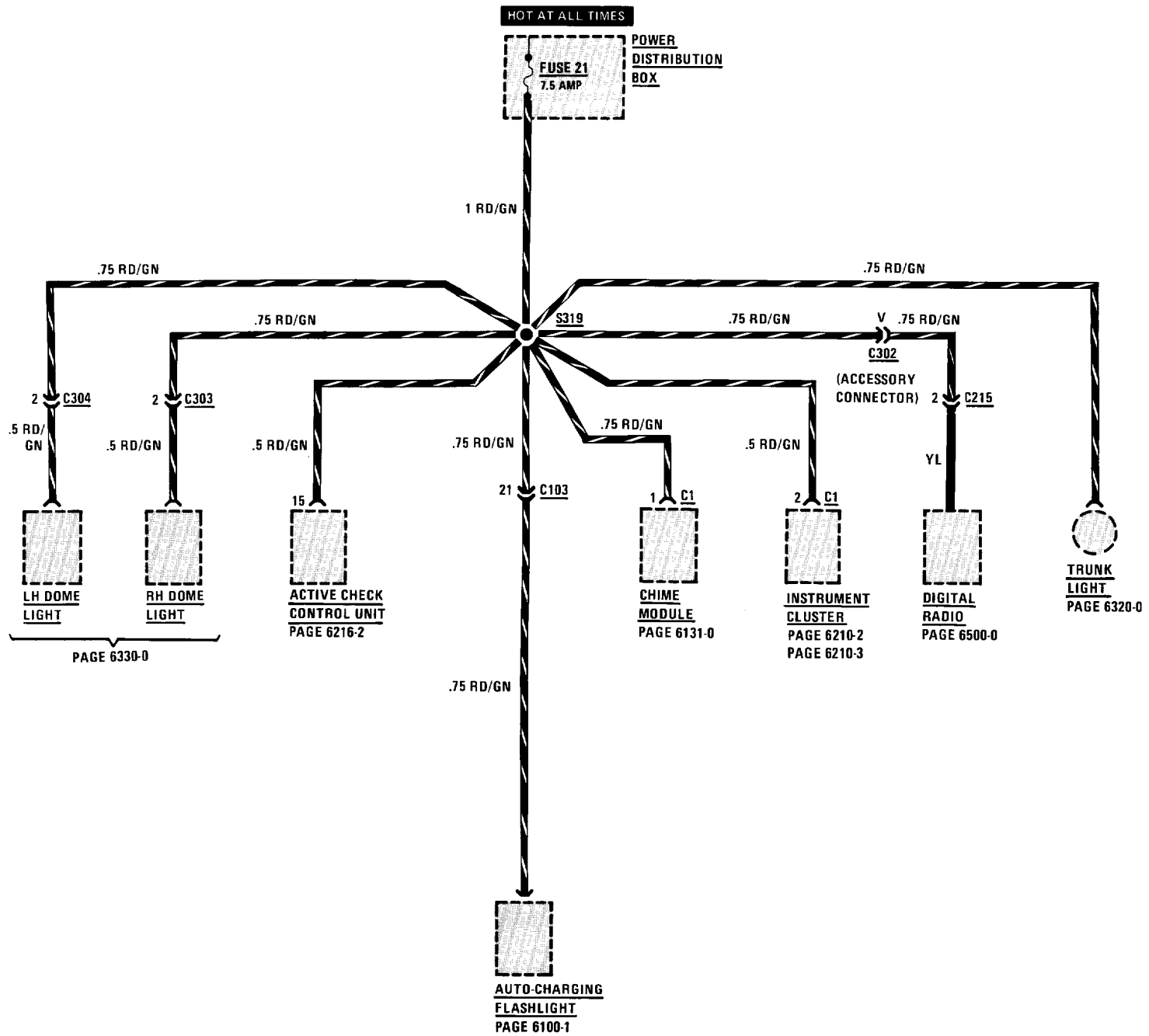

FUSE DETAILS: FUSES 27 AND 9

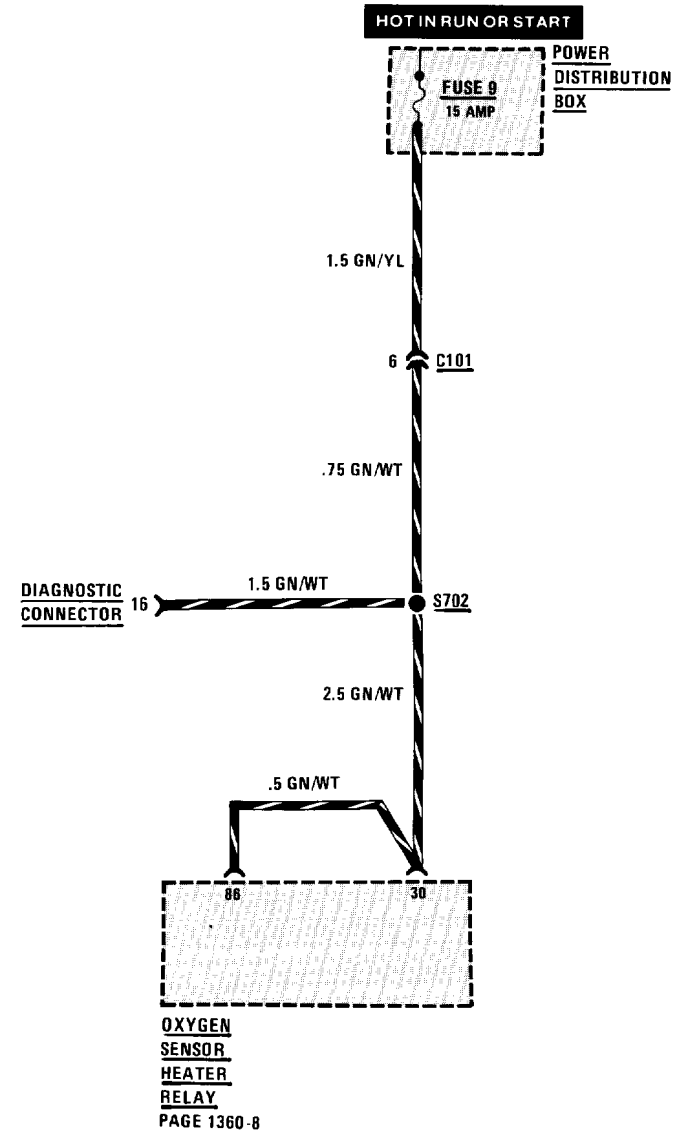
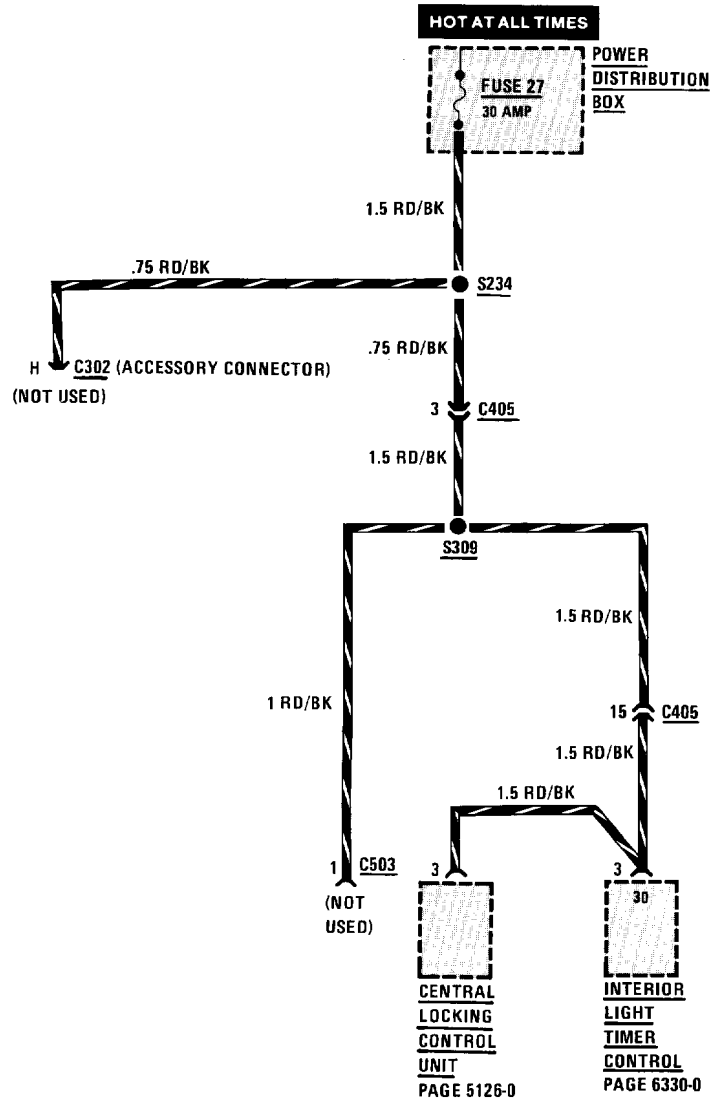

GROUND DISTRIBUTION: G103 AND G104

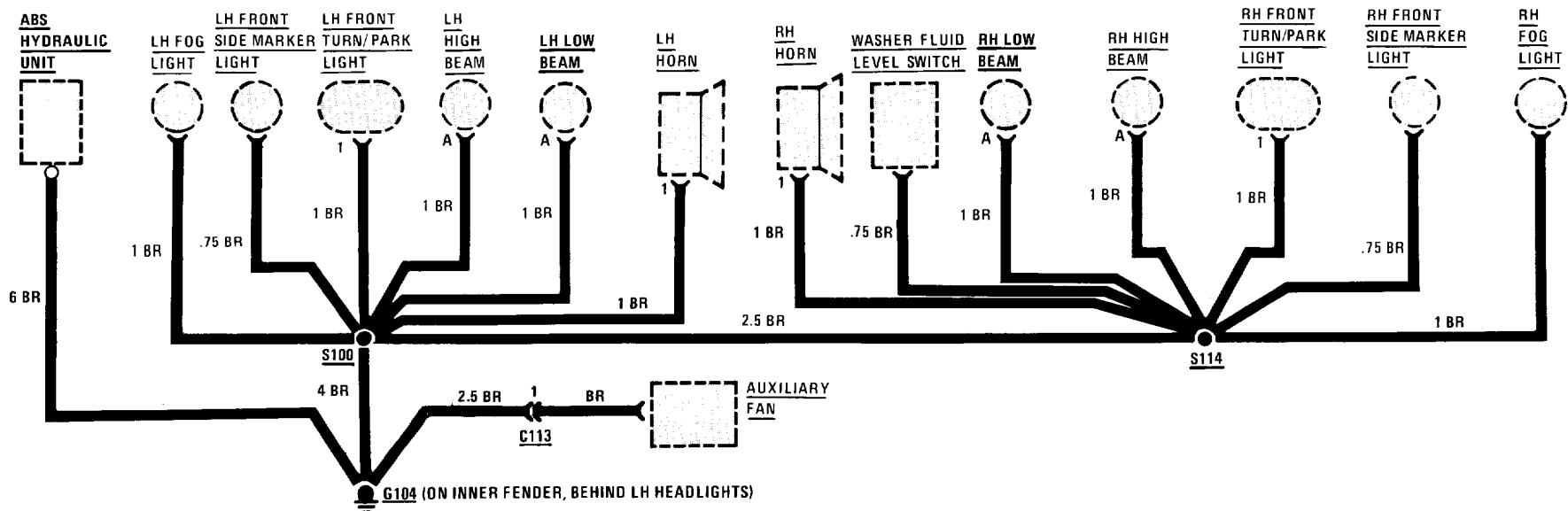
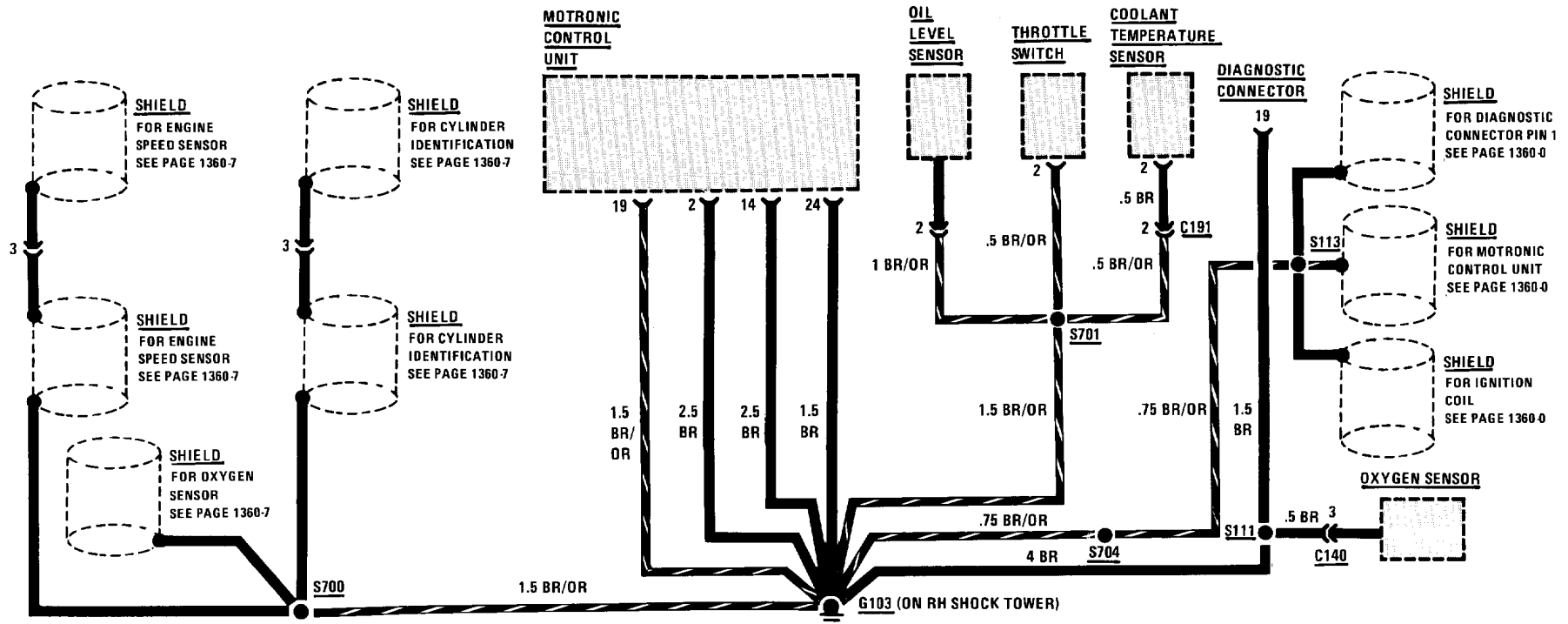

GROUND DISTRIBUTION: G200 (PARTIAL)

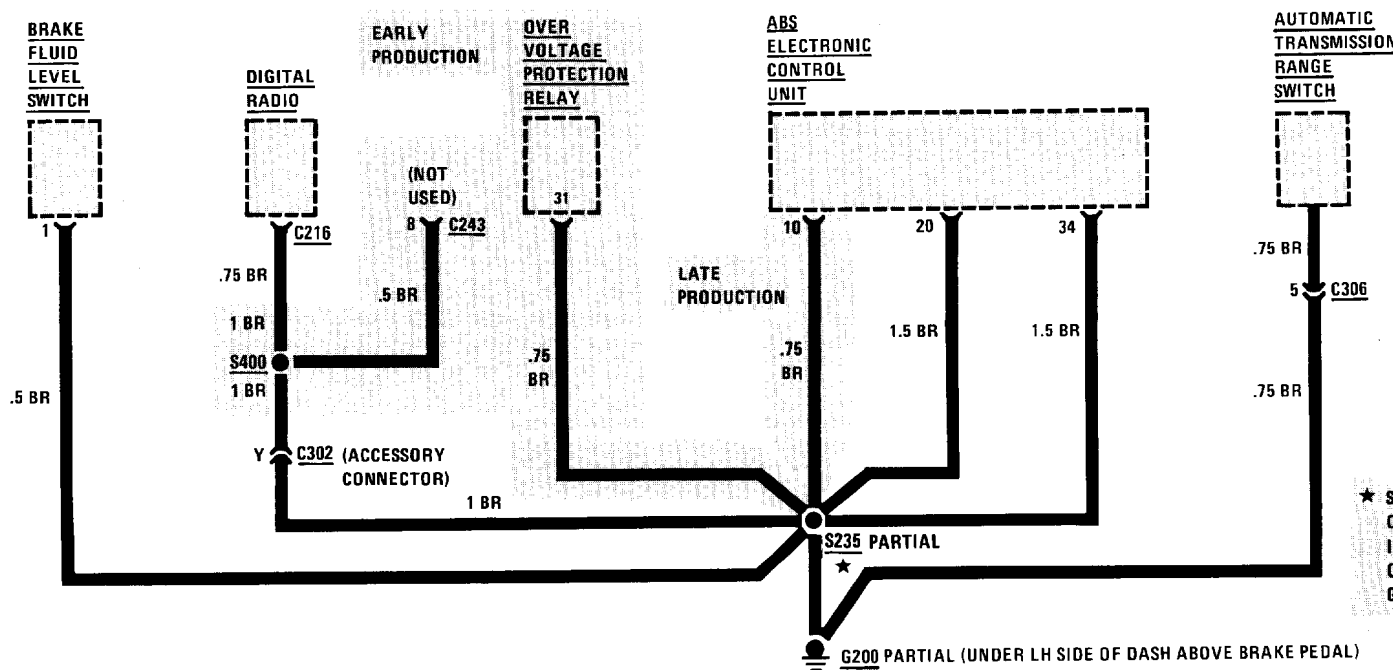
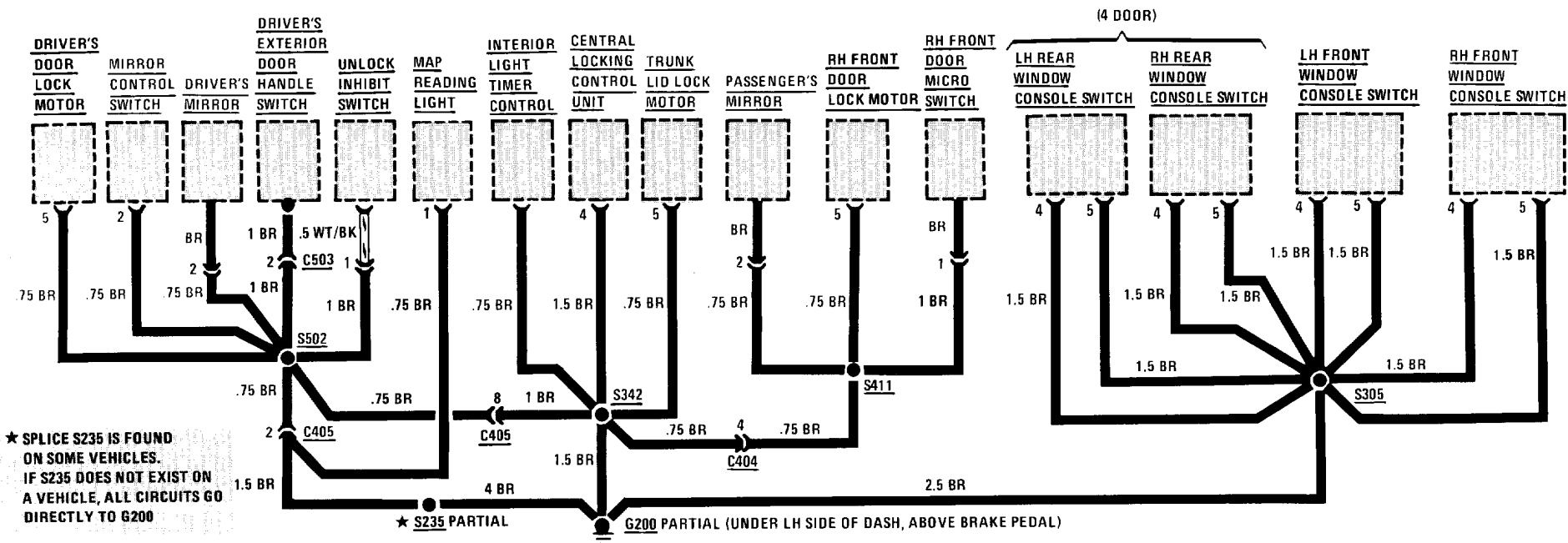

GROUND DISTRIBUTION: G200 (PARTIAL) AND G201

POWER DISTRIBUTION BOX

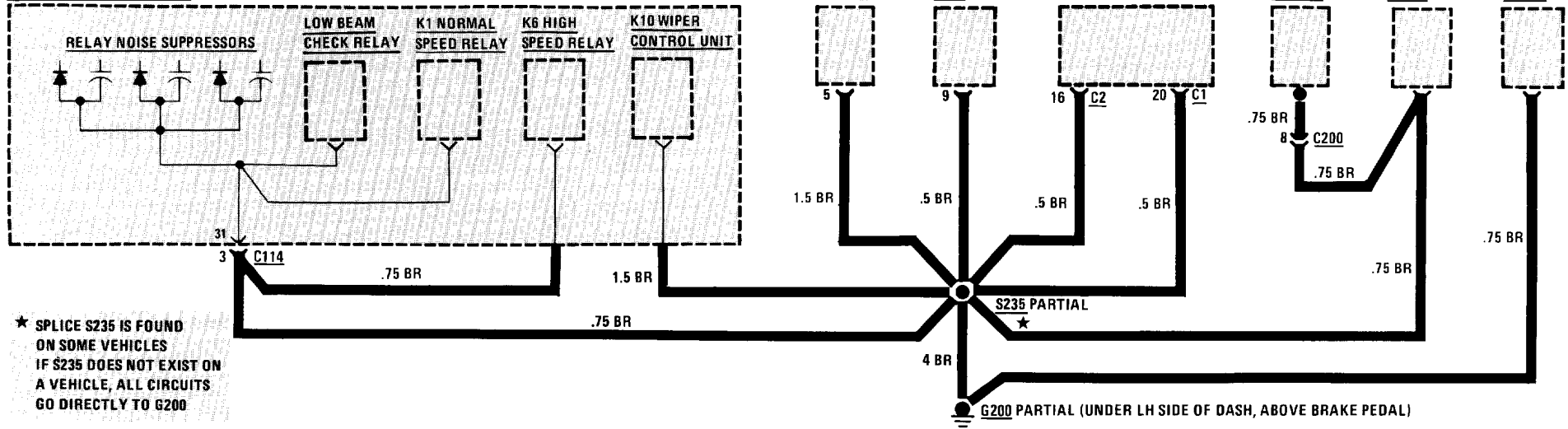

★ SPLICE S235 IS FOUND ON SOME VEHICLES
IF S235 DOES NOT EXIST ON A VEHICLE, ALL CIRCUITS GO DIRECTLY TO G200

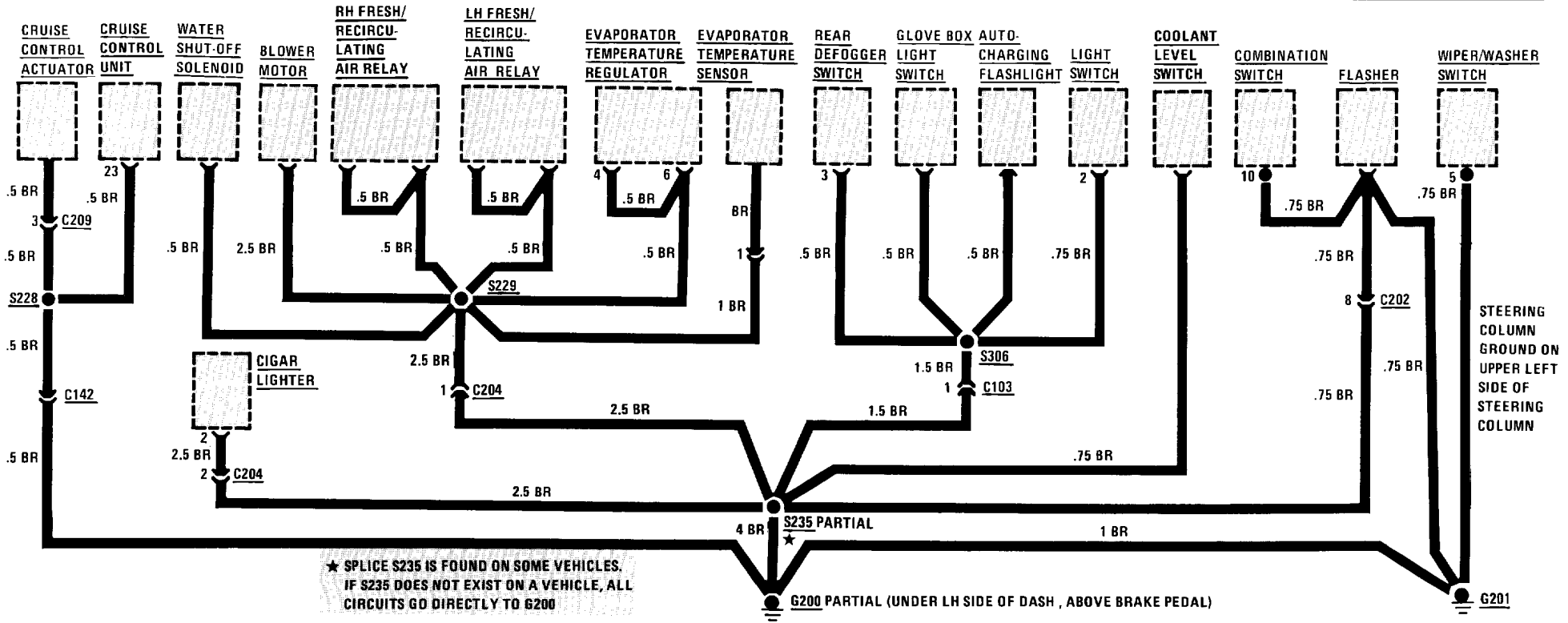

★ SPLICE S235 IS FOUND ON SOME VEHICLES.
IF S235 DOES NOT EXIST ON A VEHICLE, ALL CIRCUITS GO DIRECTLY TO G200

GROUND DISTRIBUTION: G200 (PARTIAL)

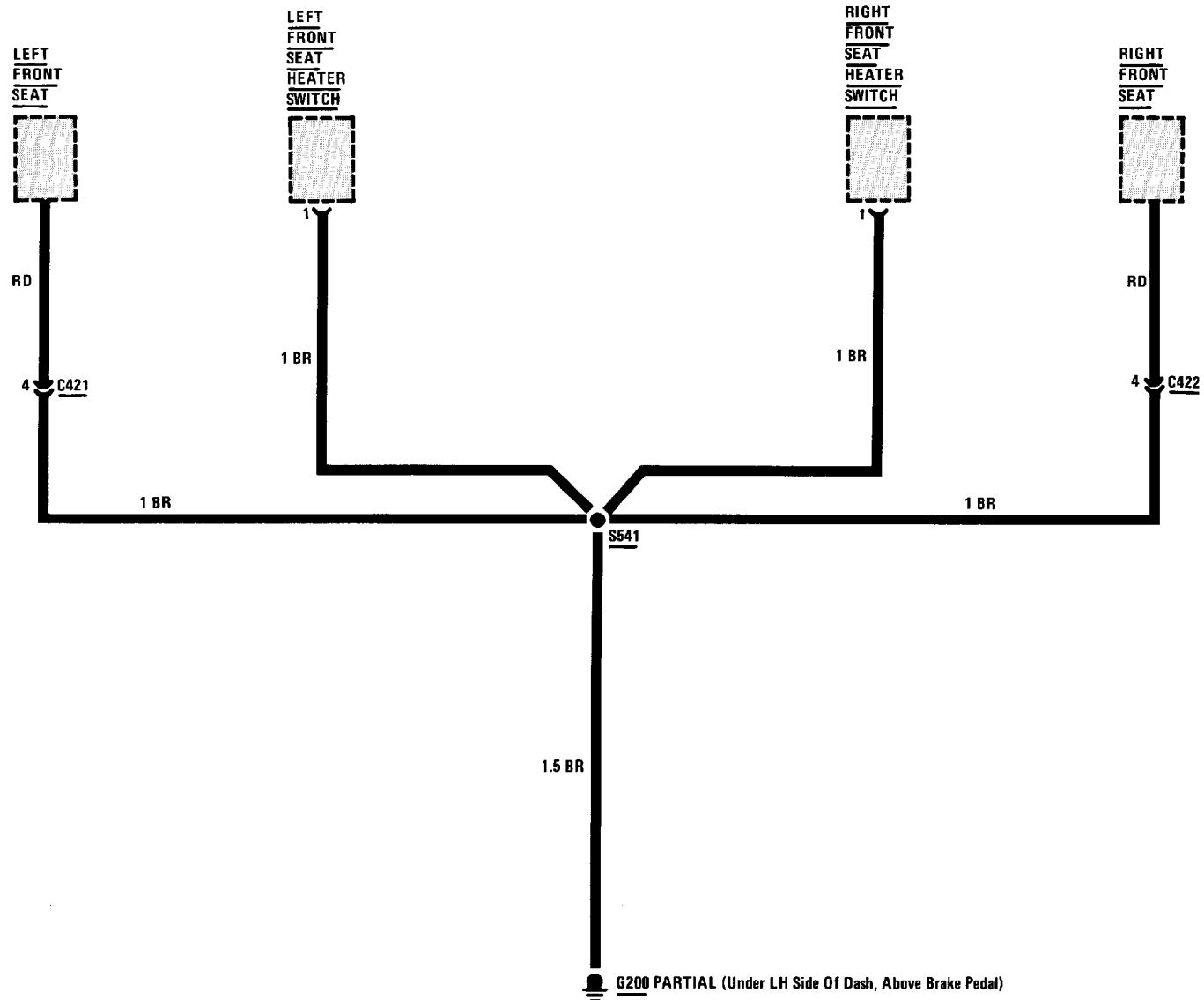

GROUND DISTRIBUTION: G300

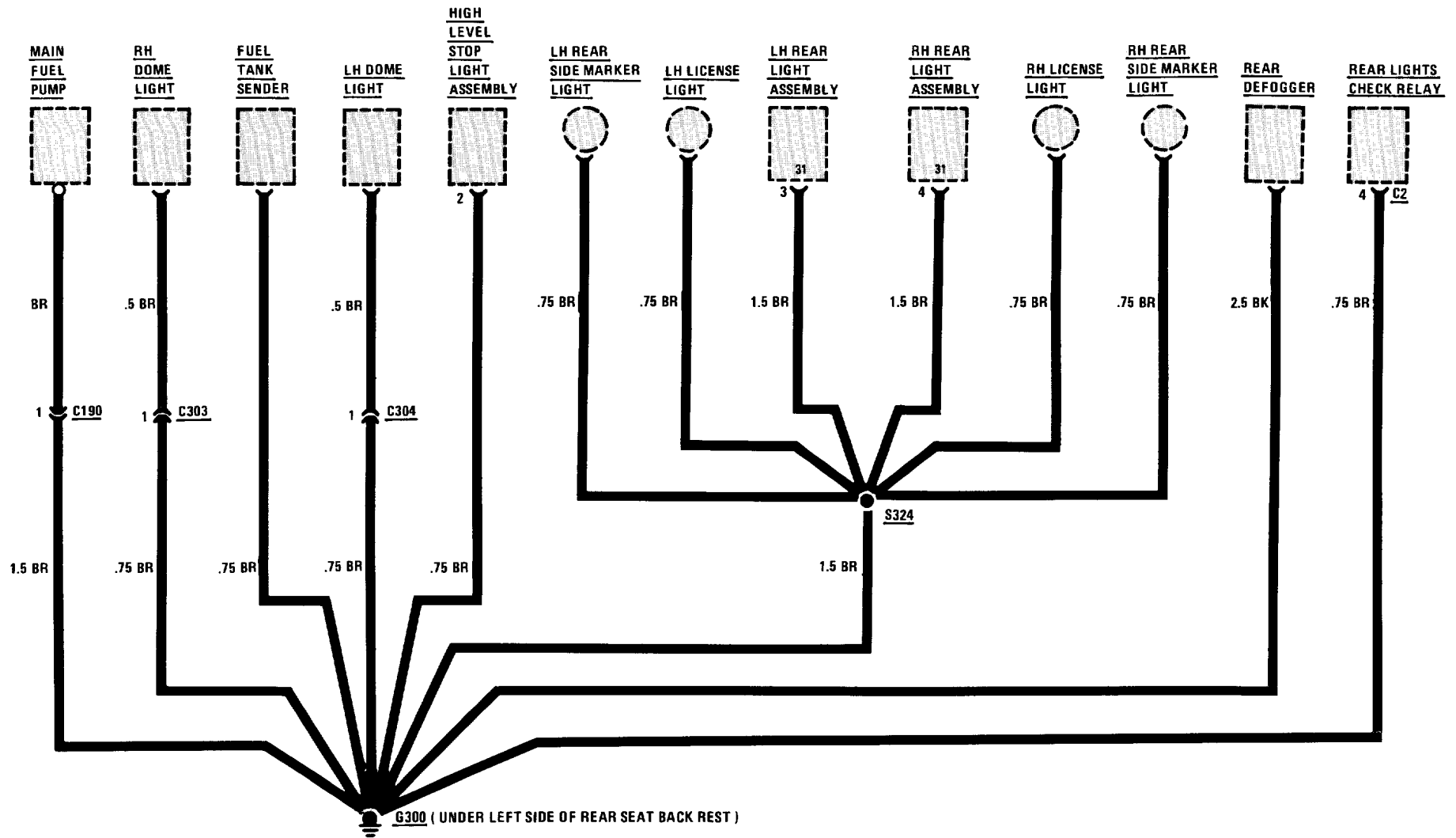

1230-0 CHARGE

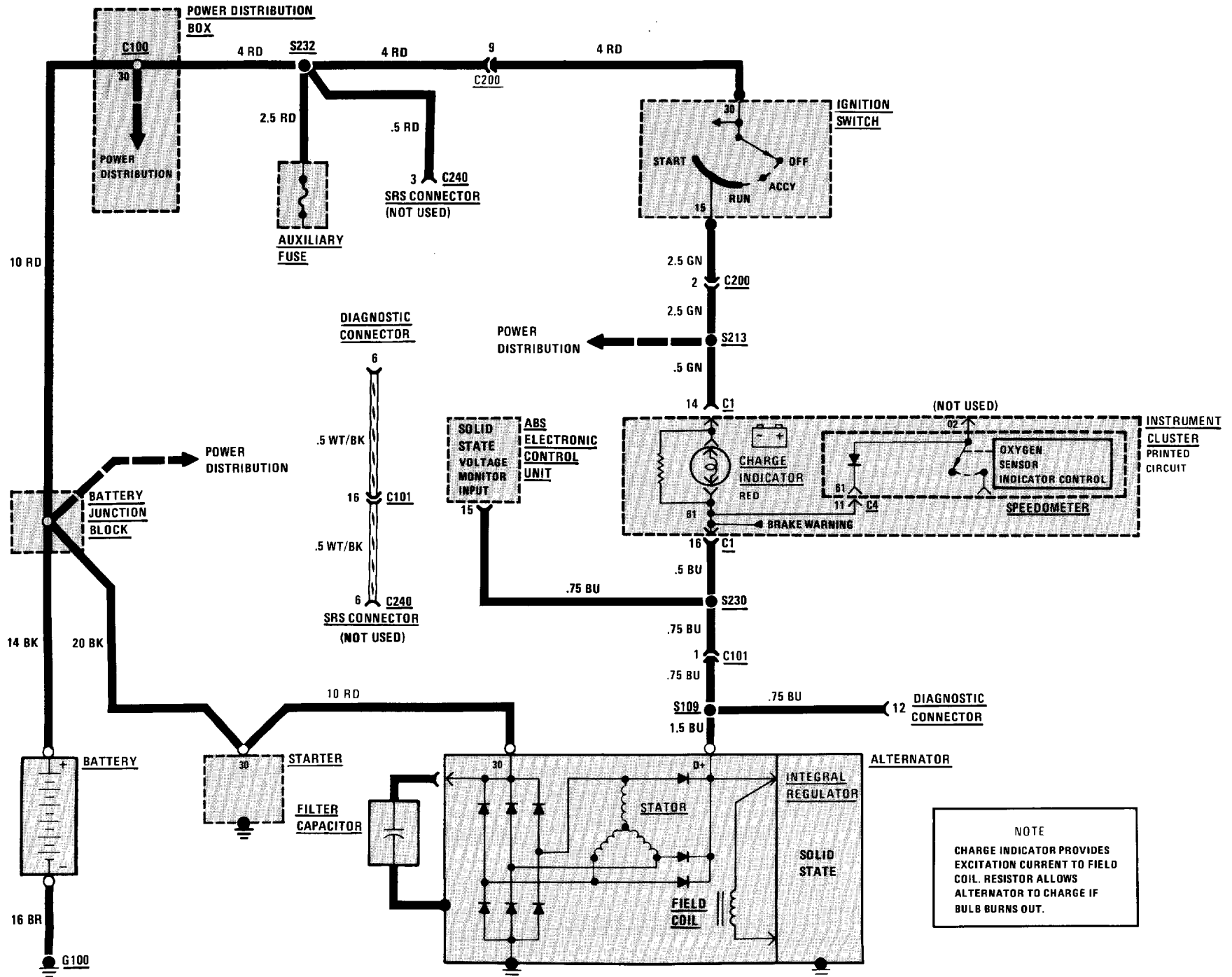

AUTOMATIC TRANSMISSION

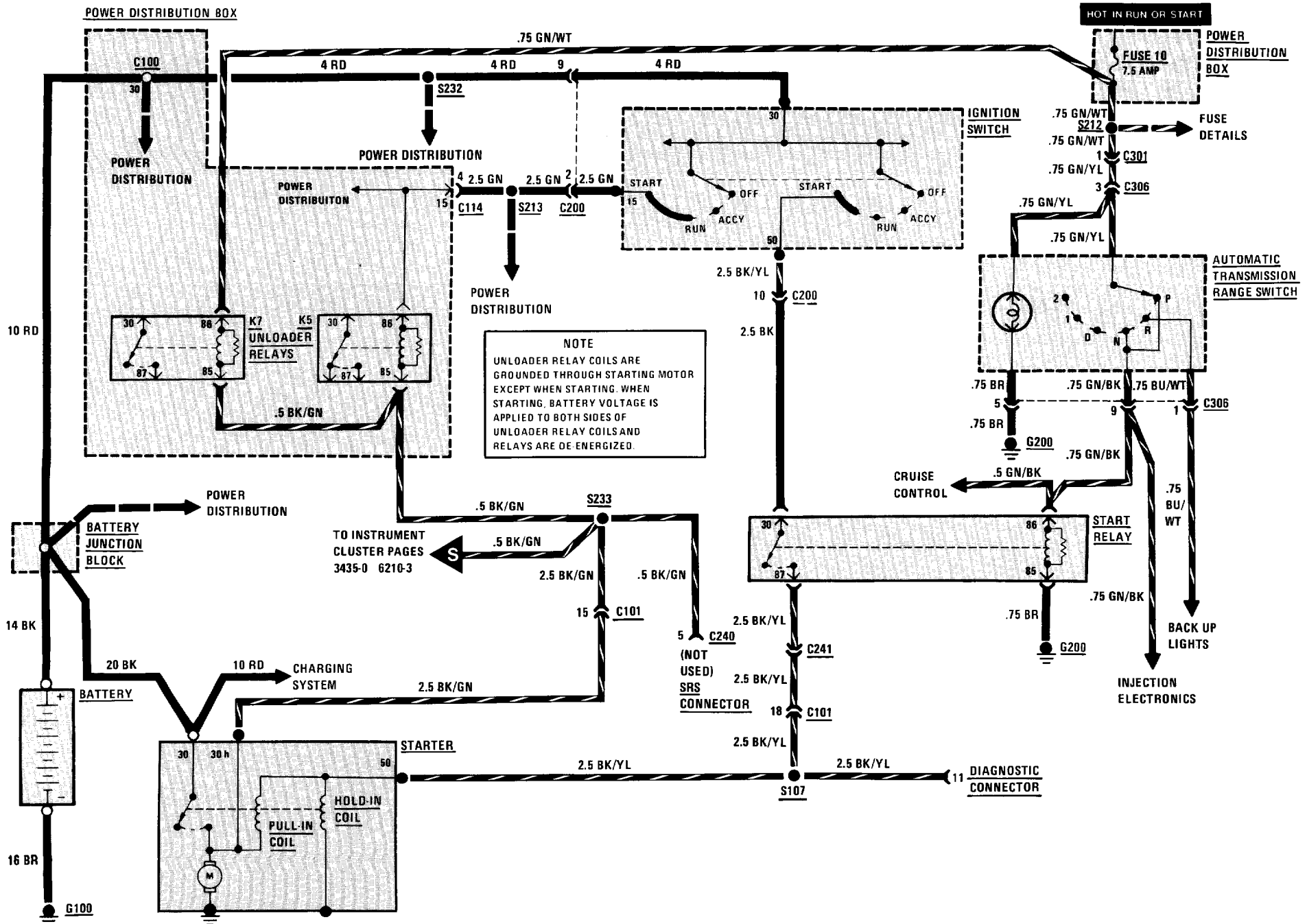

MANUAL TRANSMISSION

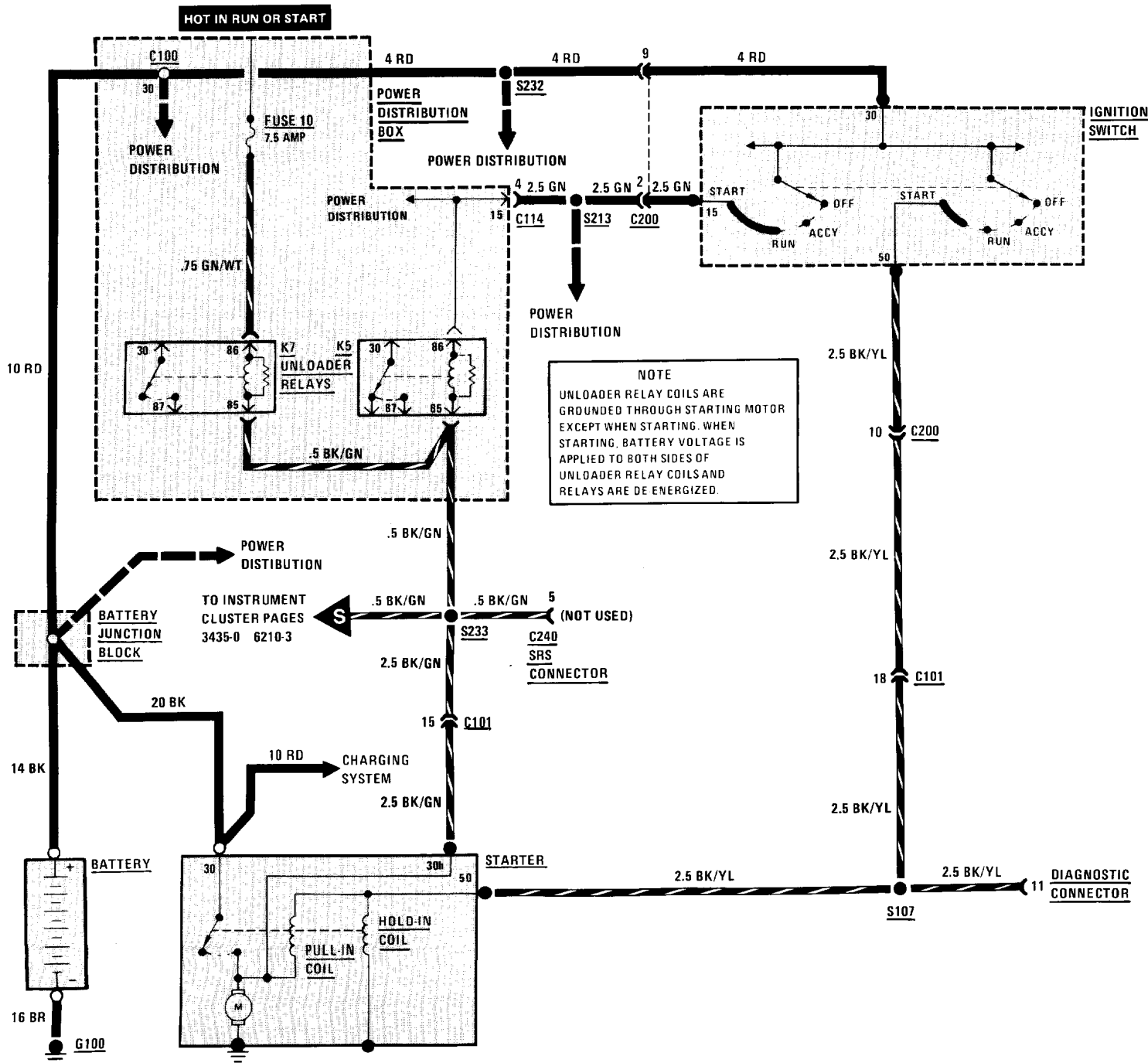

ENGINE BLOCK DIAGRAM

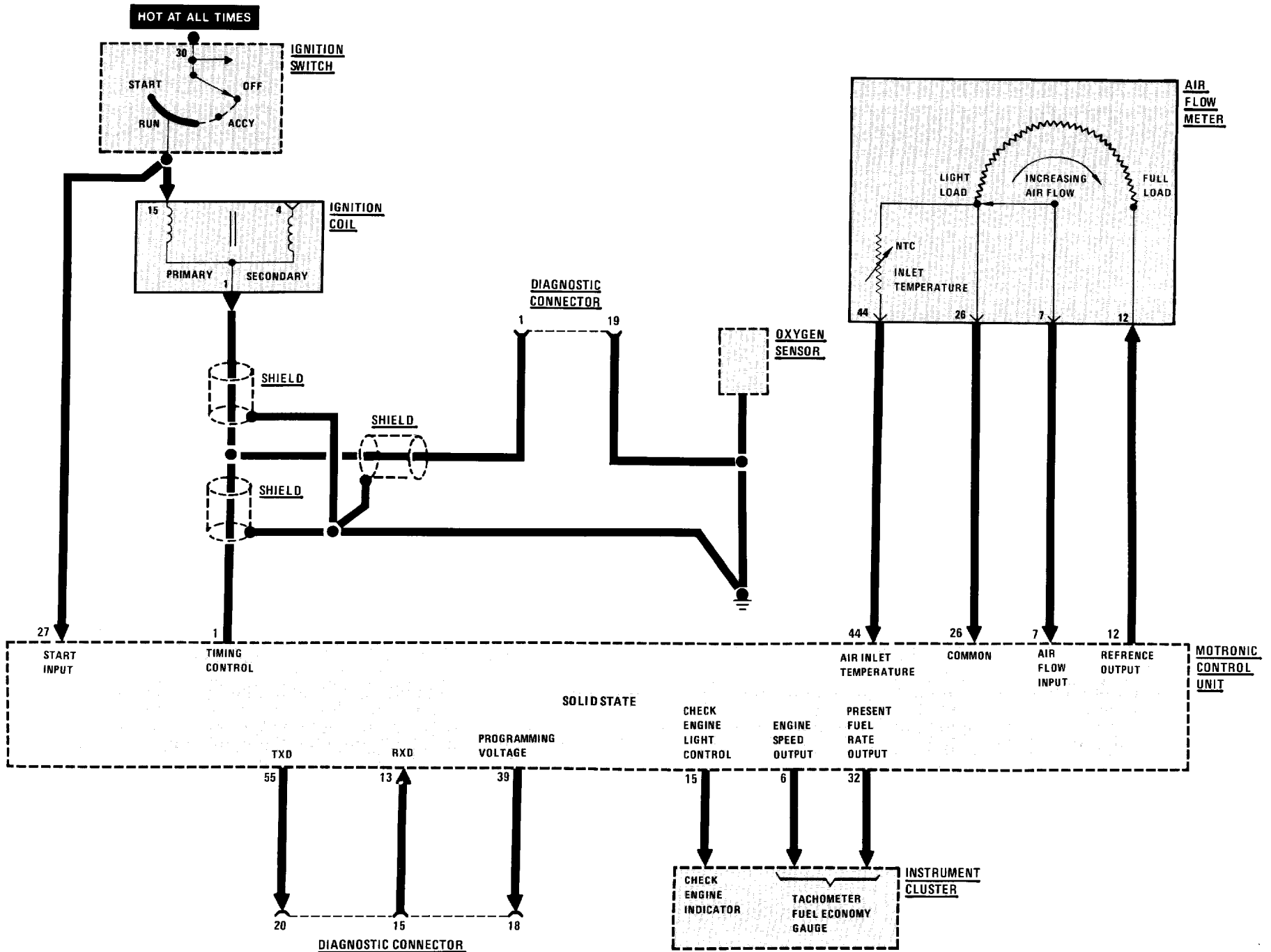

ENGINE BLOCK DIAGRAM

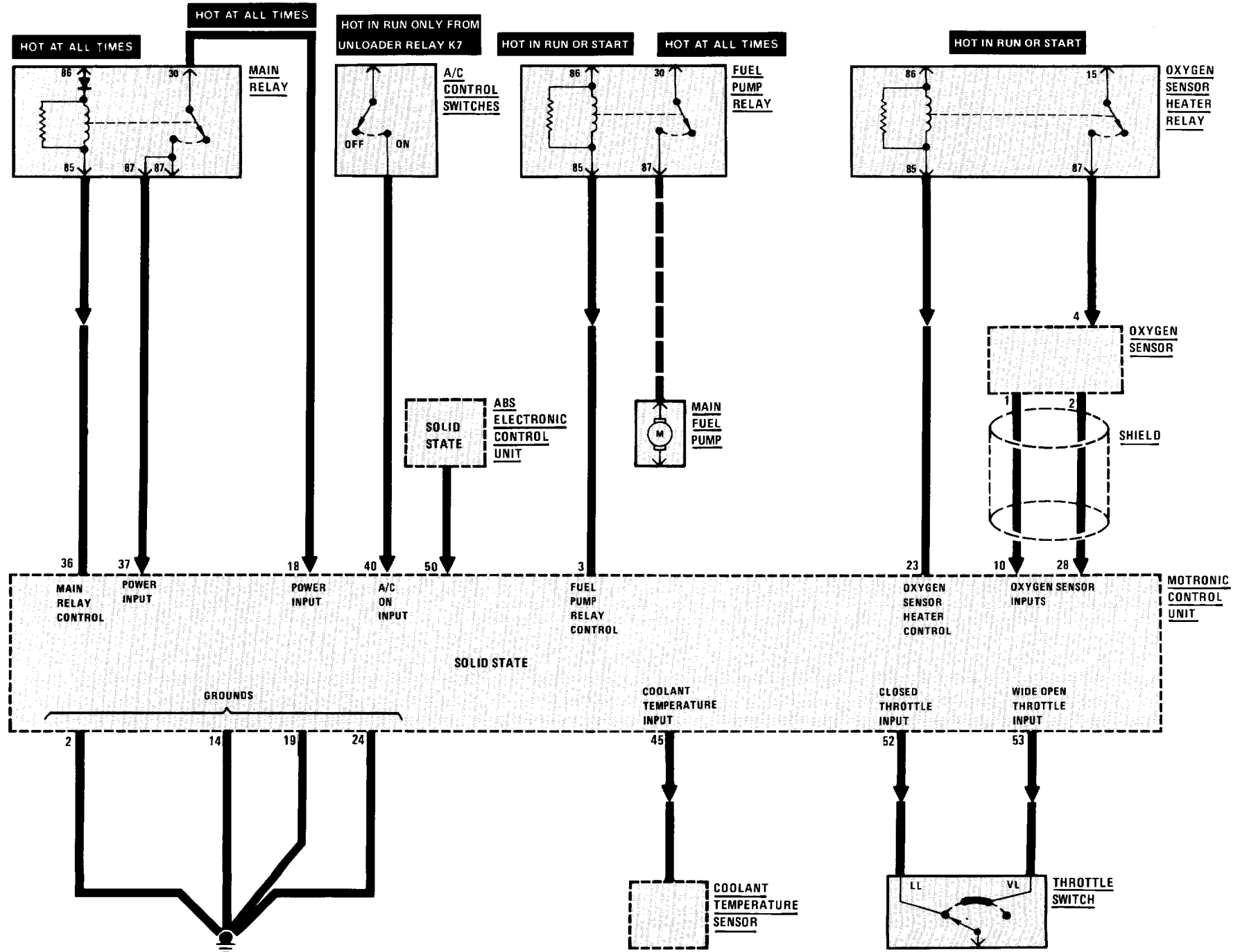

1360-2 INJECTION ELECTRONICS

ENGINE BLOCK DIAGRAM

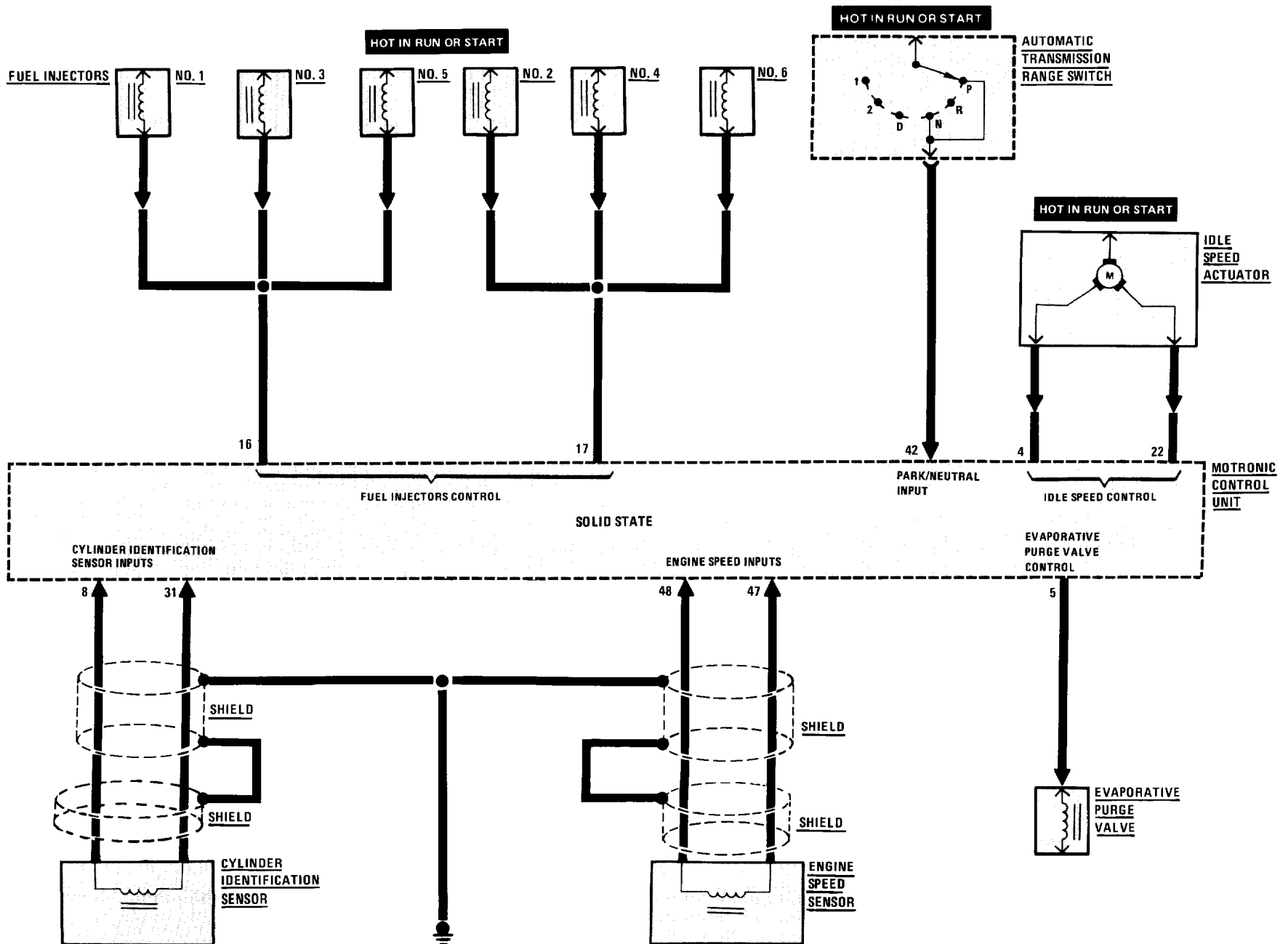

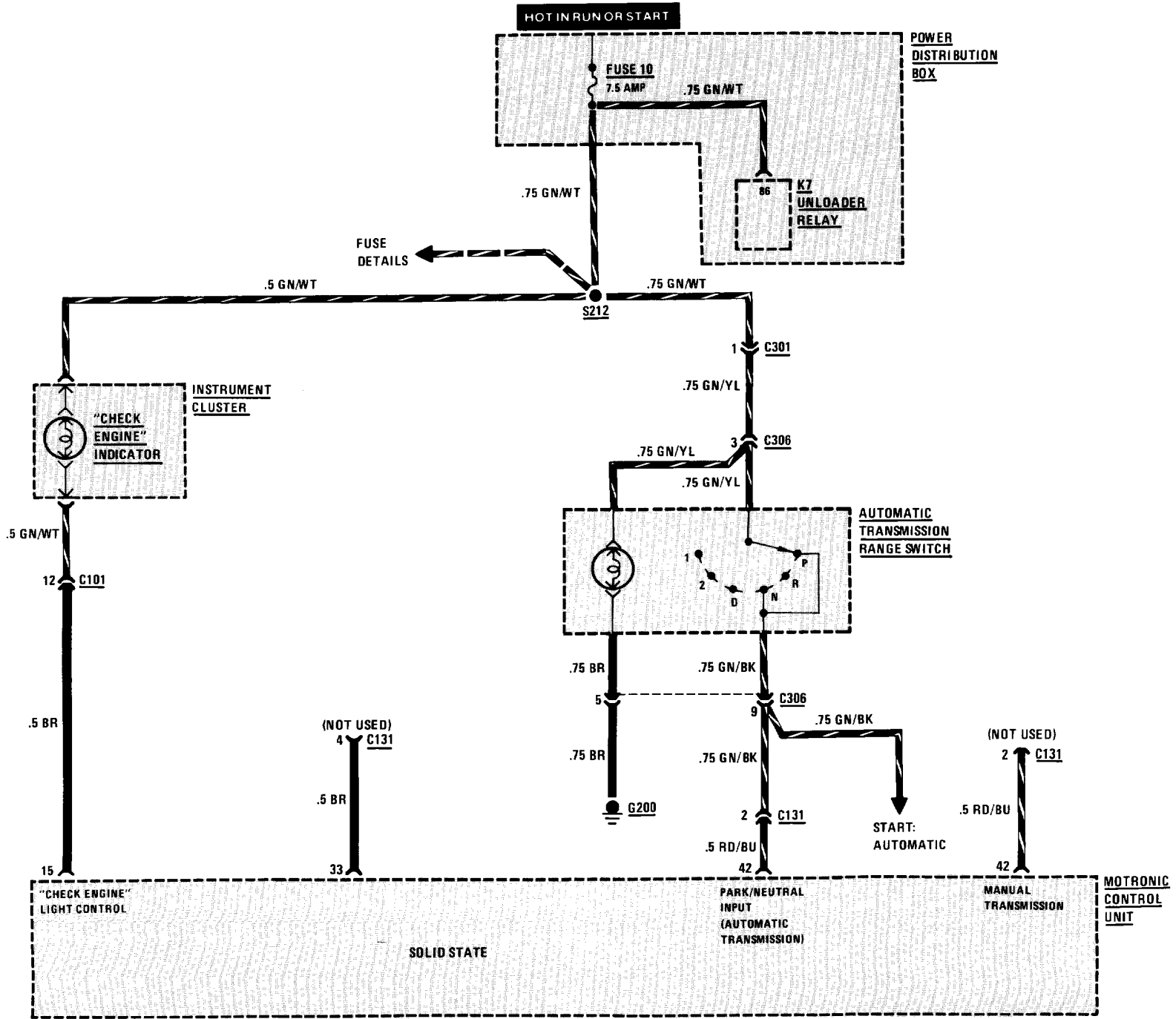

1360-4 INJECTION ELECTRONICS

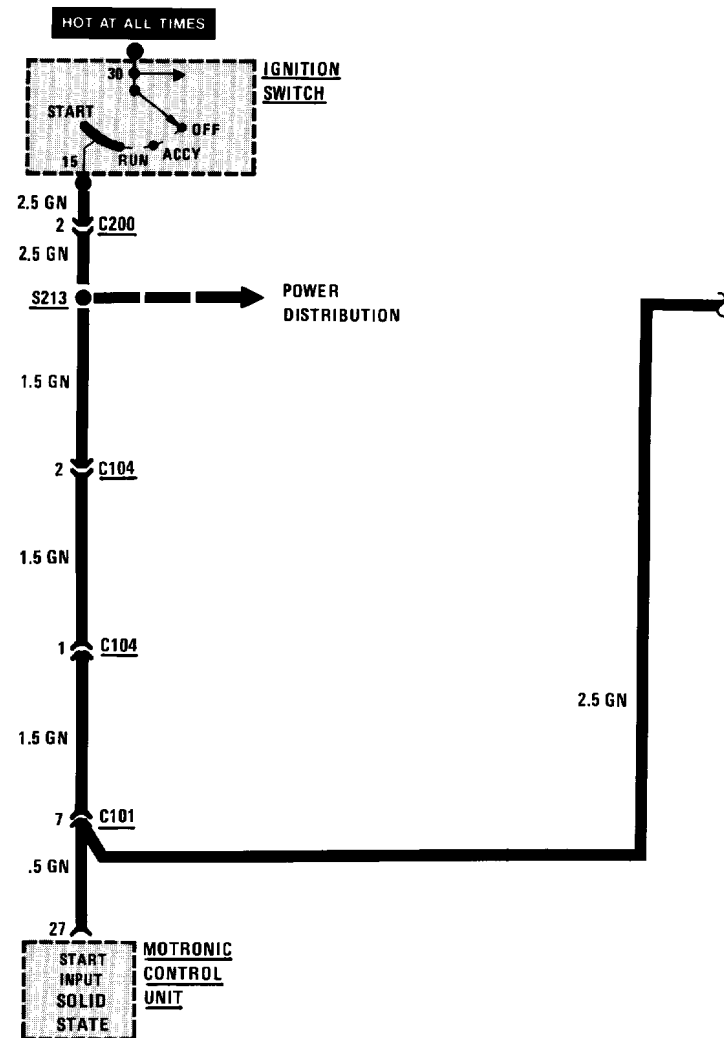
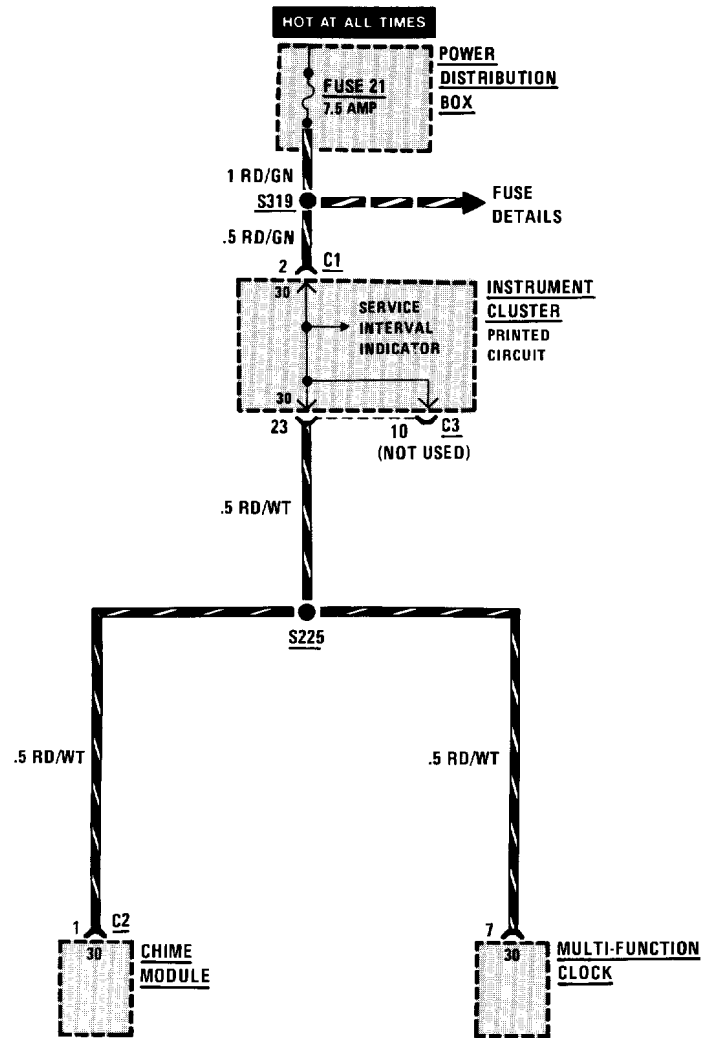

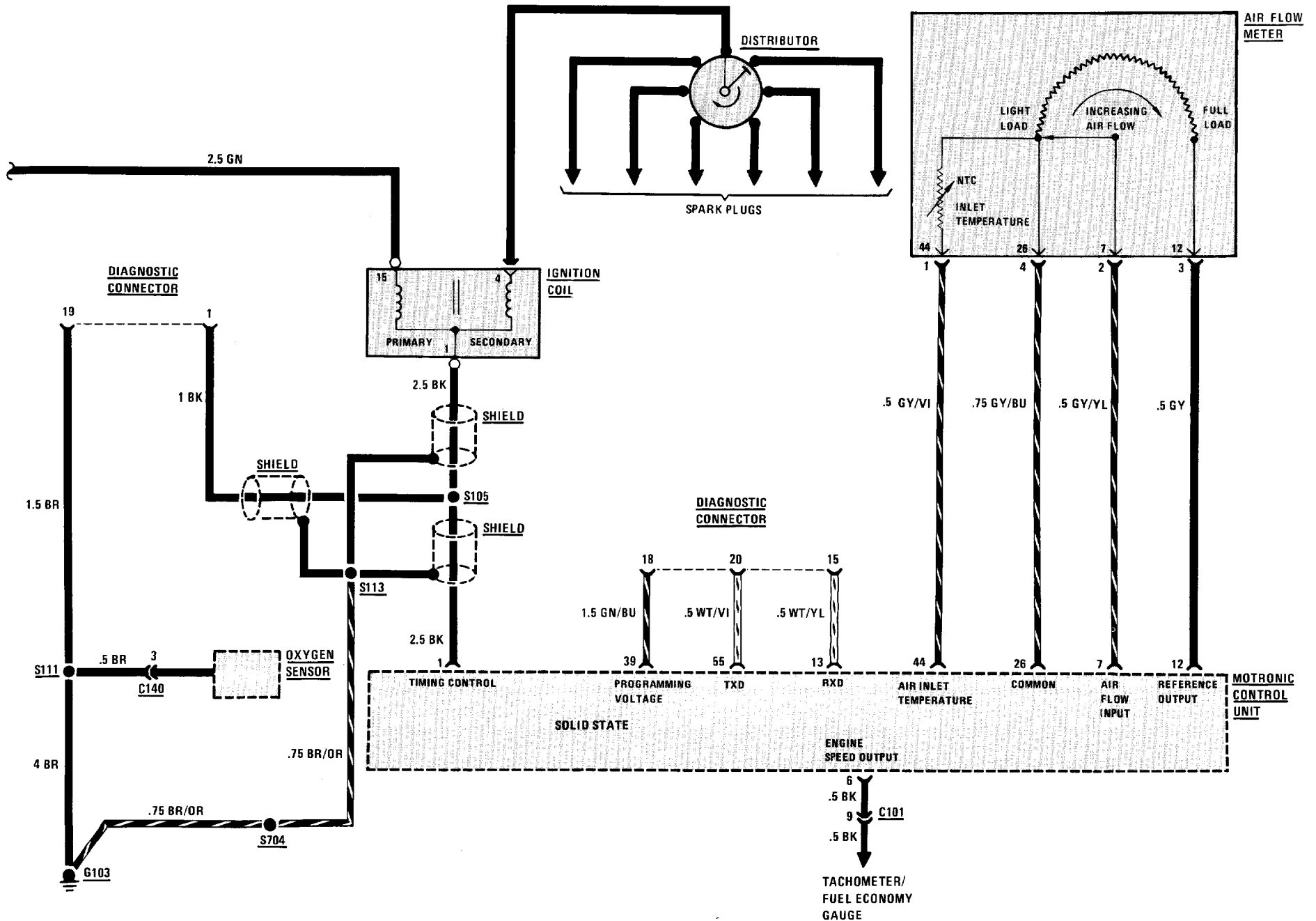

1360-6 INJECTION ELECTRONICS

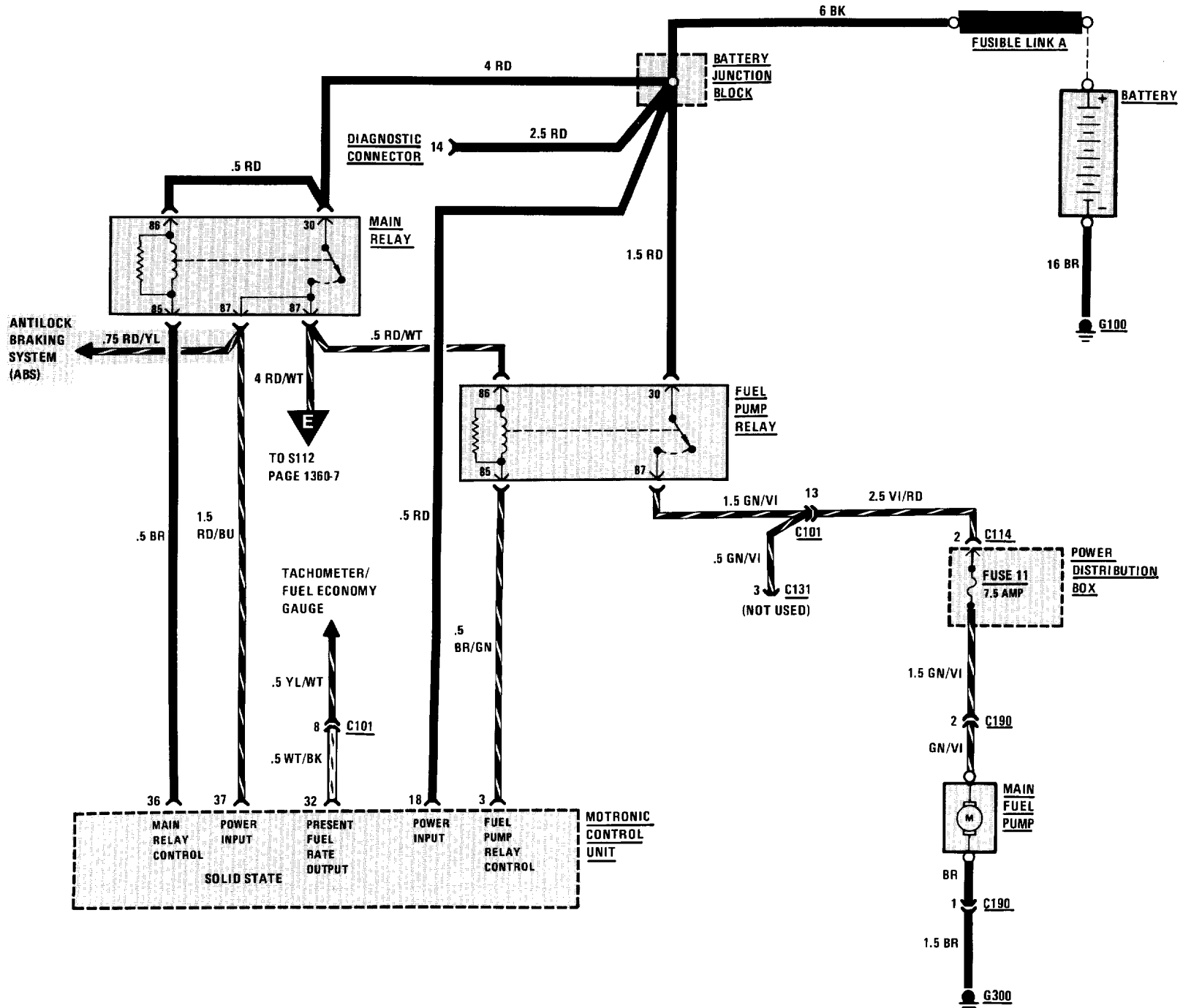

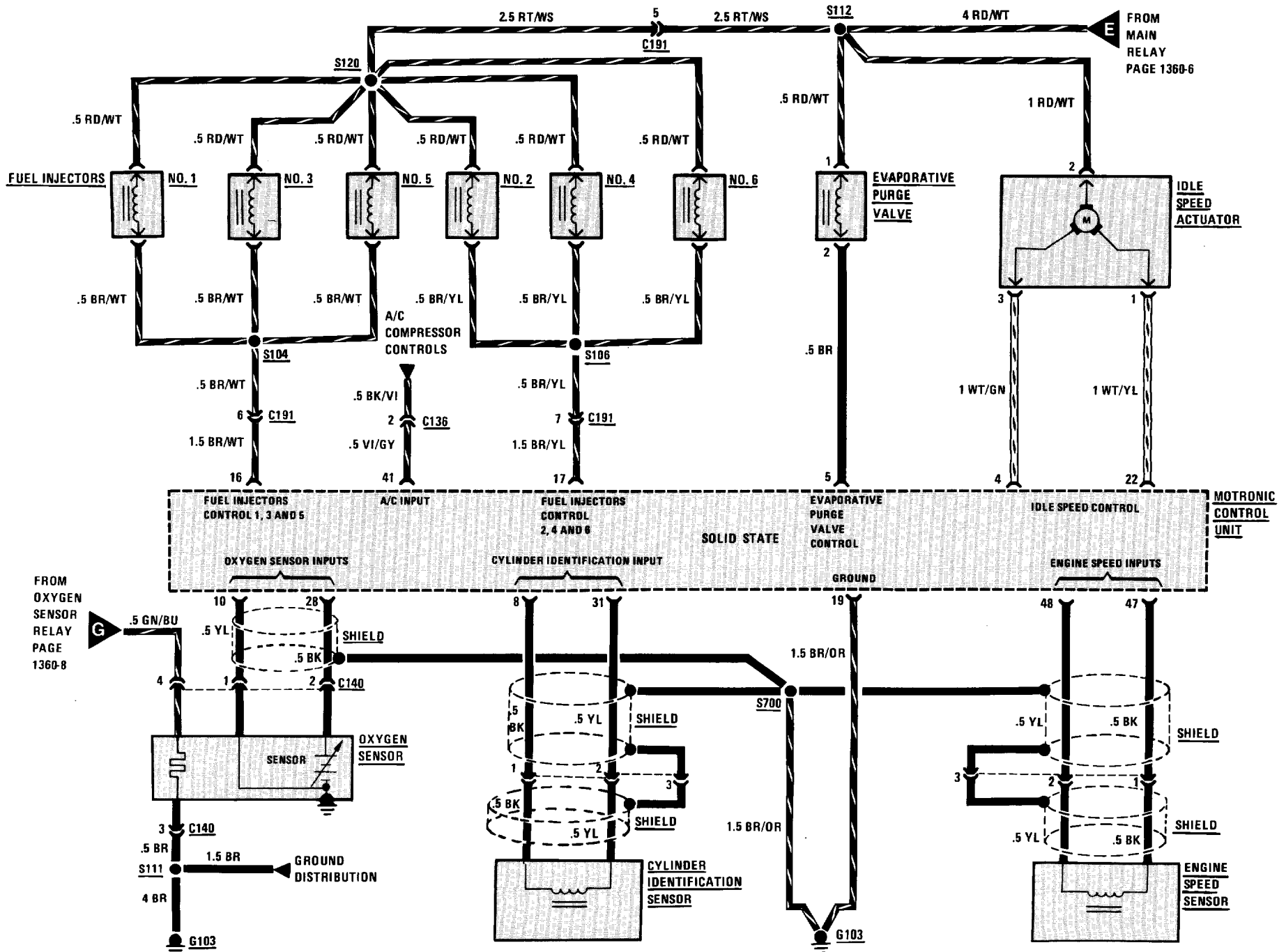

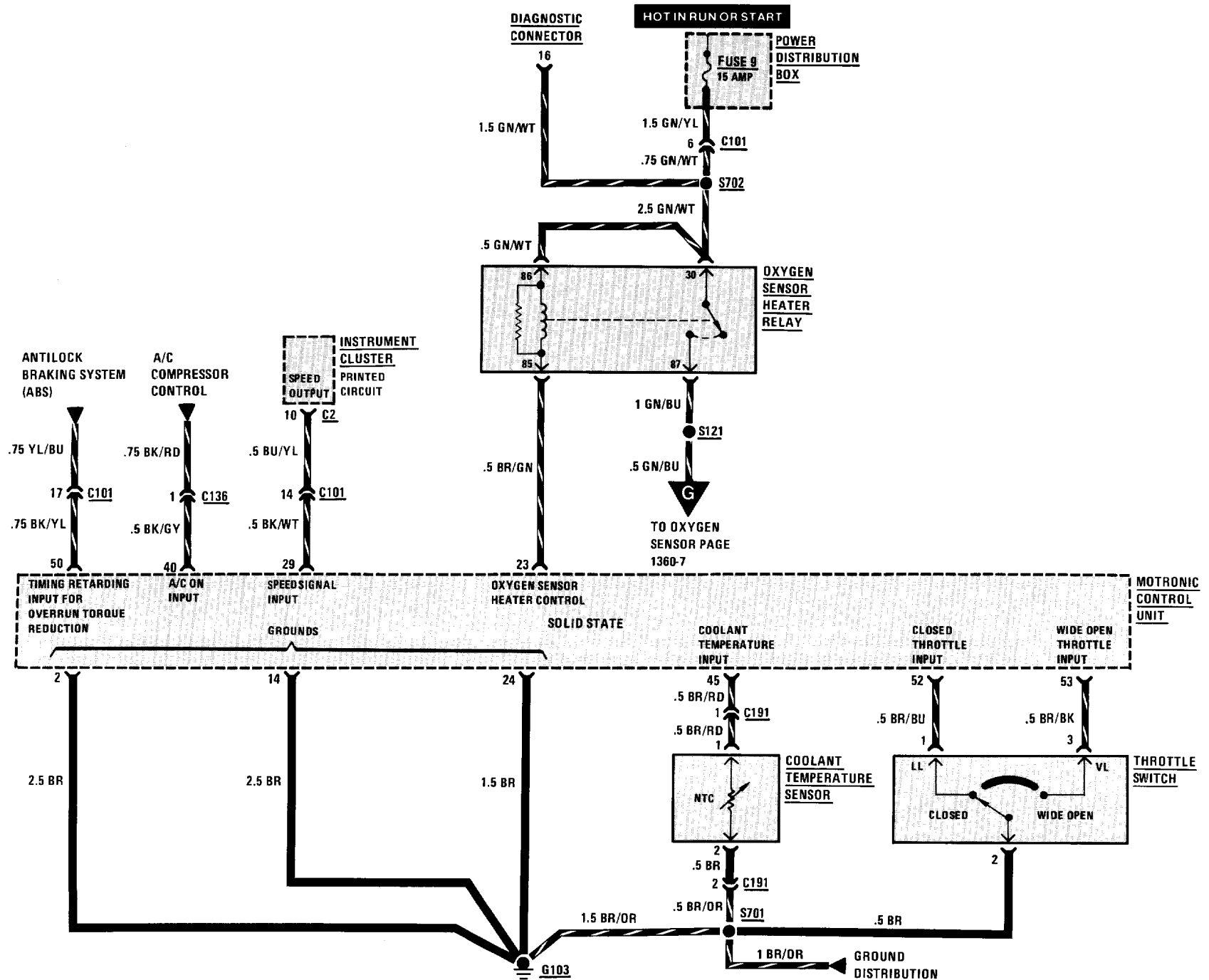

3435-0 BRAKE WARNING SYSTEM

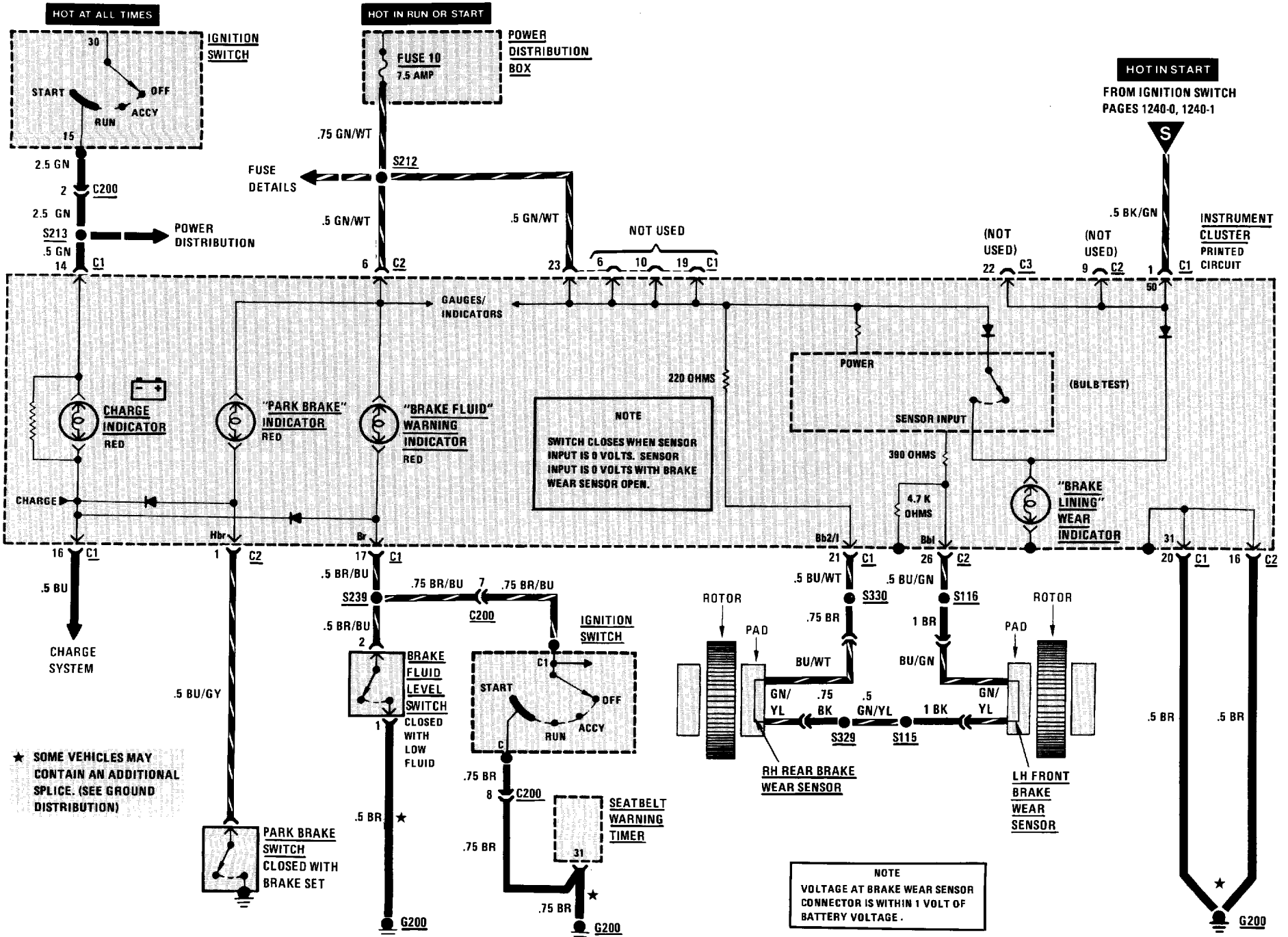

3450-0 ANTILOCK BRAKING SYSTEM (ABS)

EARLY PRODUCTION

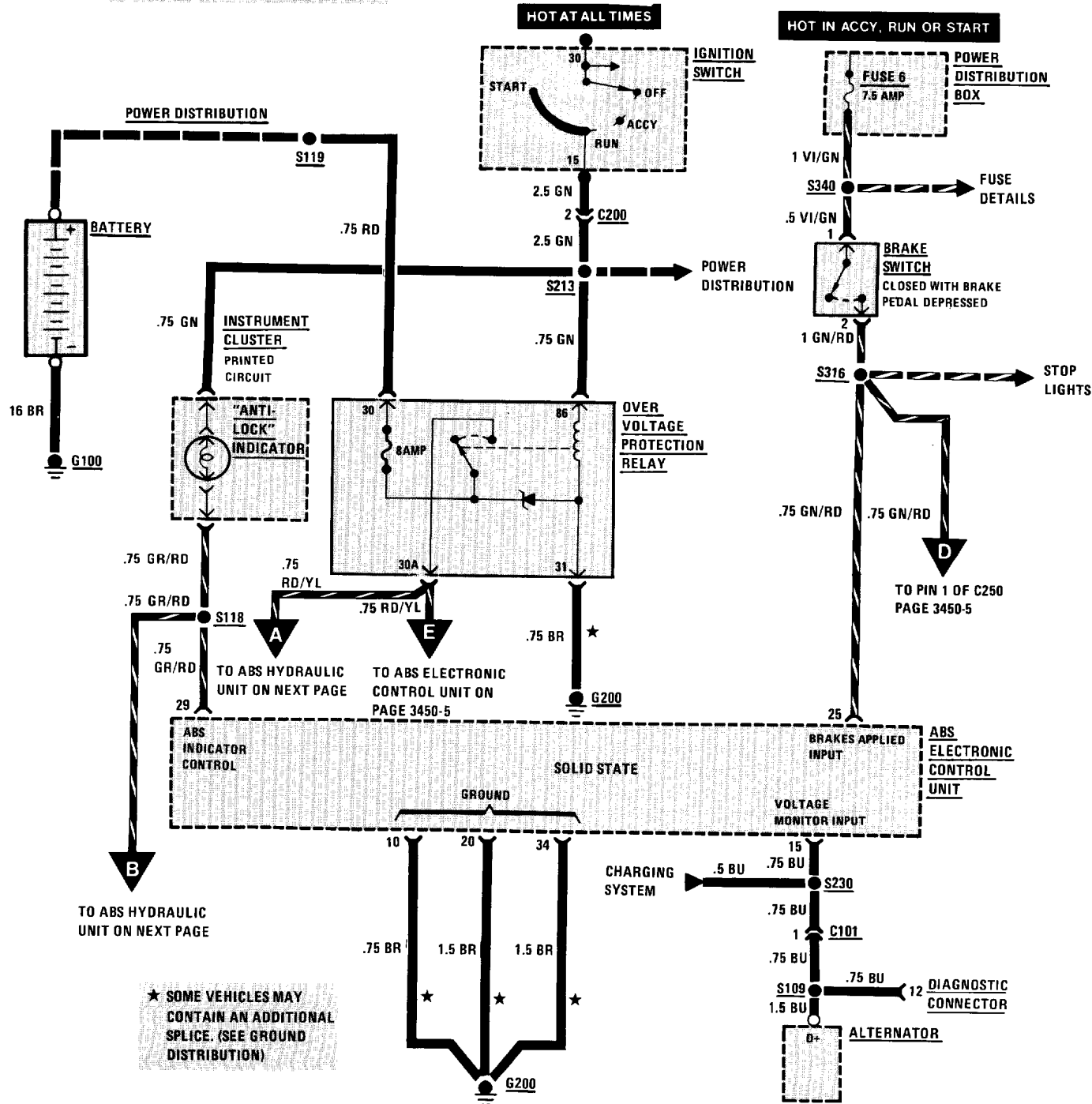

★ SOME VEHICLES MAY CONTAIN AN ADDITIONAL SPLICE. (SEE GROUND DISTRIBUTION)

EARLY PRODUCTION

CONTINUED FROM OVER
VOLTAGE PROTECTION
RELAY ON PREVIOUS PAGE

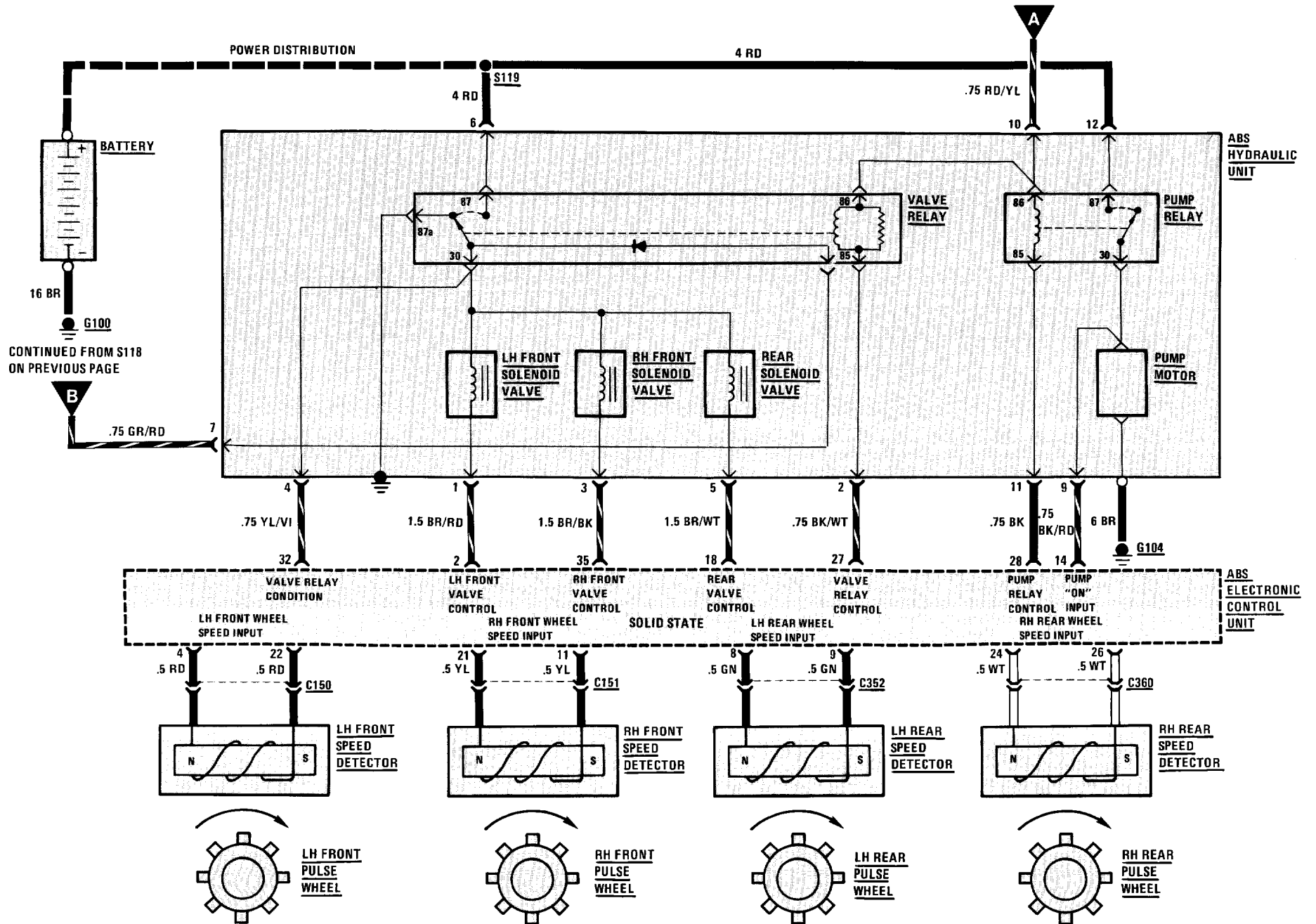

3450-2 ANTILOCK BRAKING SYSTEM (ABS)

LATE PRODUCTION

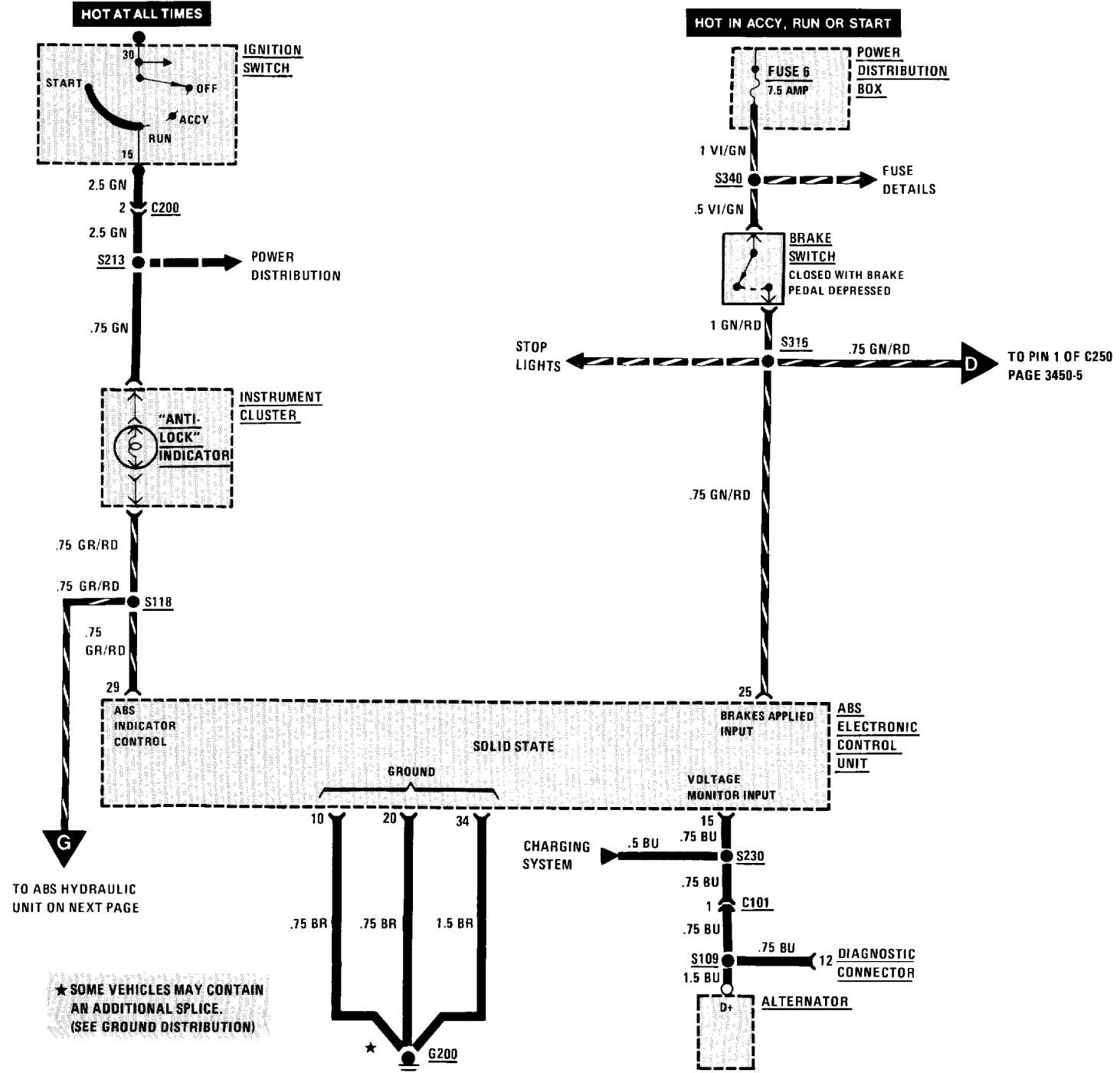

LATE PRODUCTION

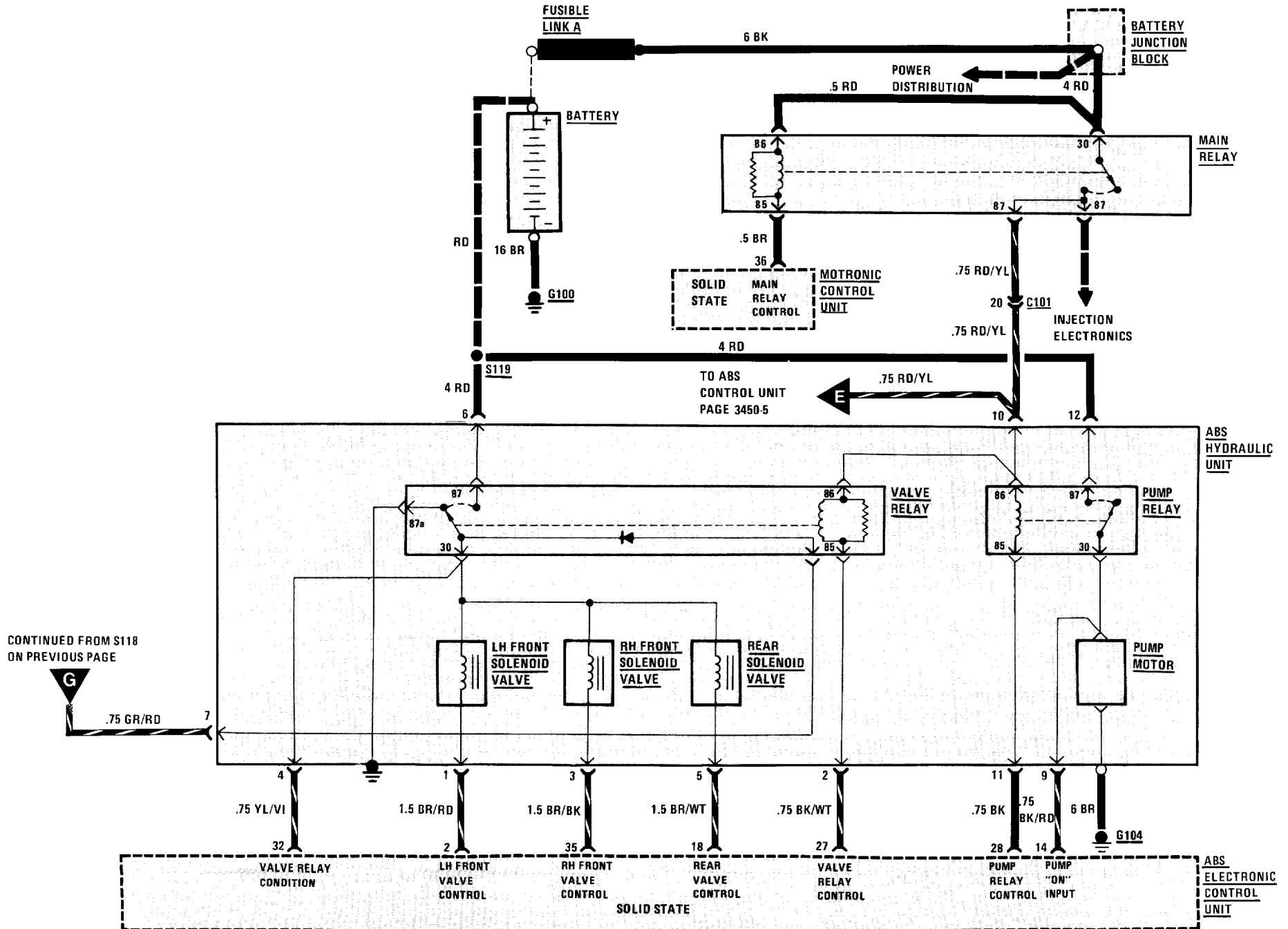

CONTINUED FROM S118 ON PREVIOUS PAGE

3450-4 ANTILOCK BRAKING SYSTEM (ABS)

LATE PRODUCITON

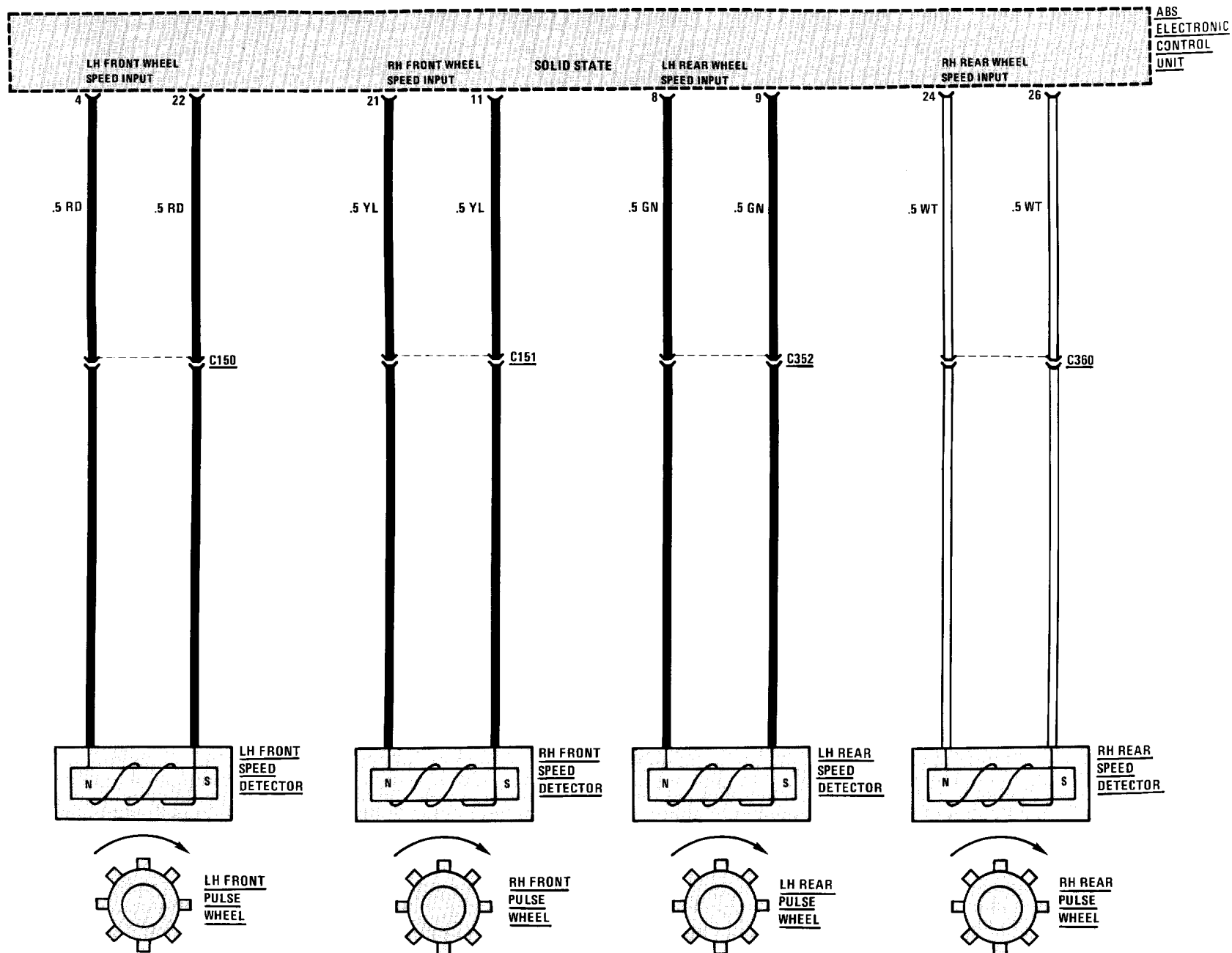

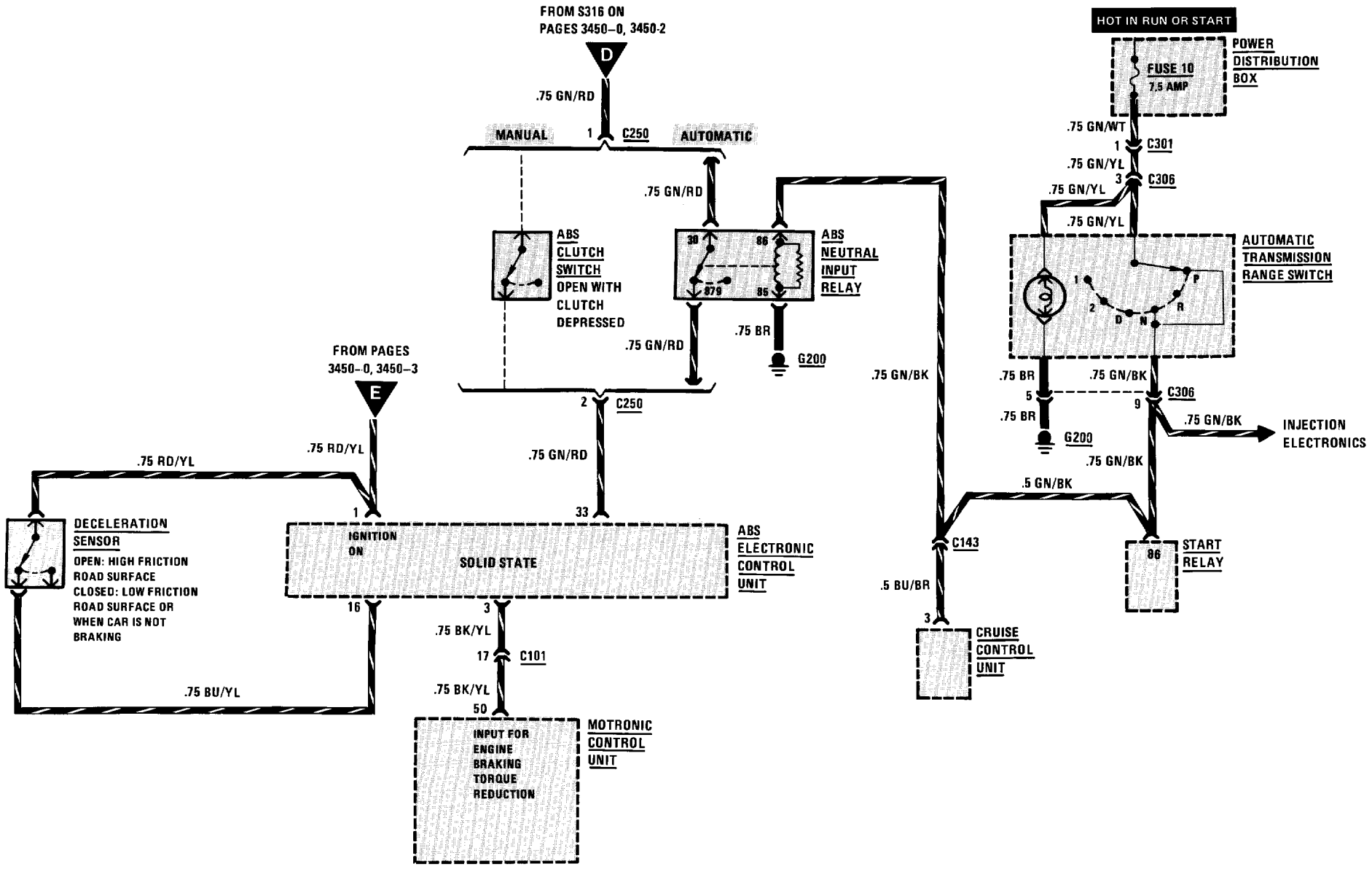

5116-0 POWER MIRRORS

HOT IN RUN ONLY FROM UNLOADER RELAY K7

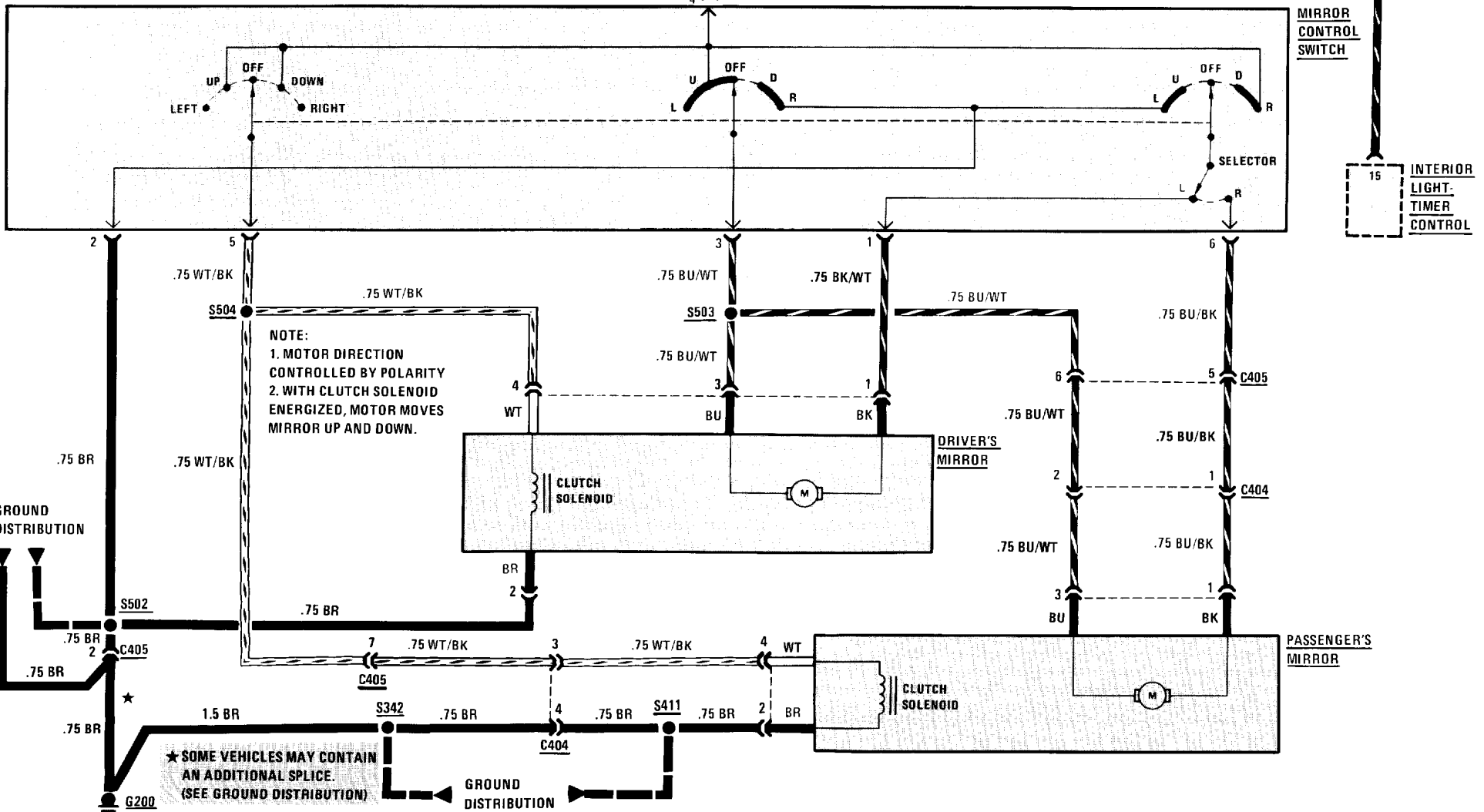
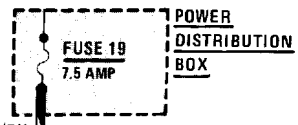

5126-0 CENTRAL LOCKING

2 DOOR (SELECT)

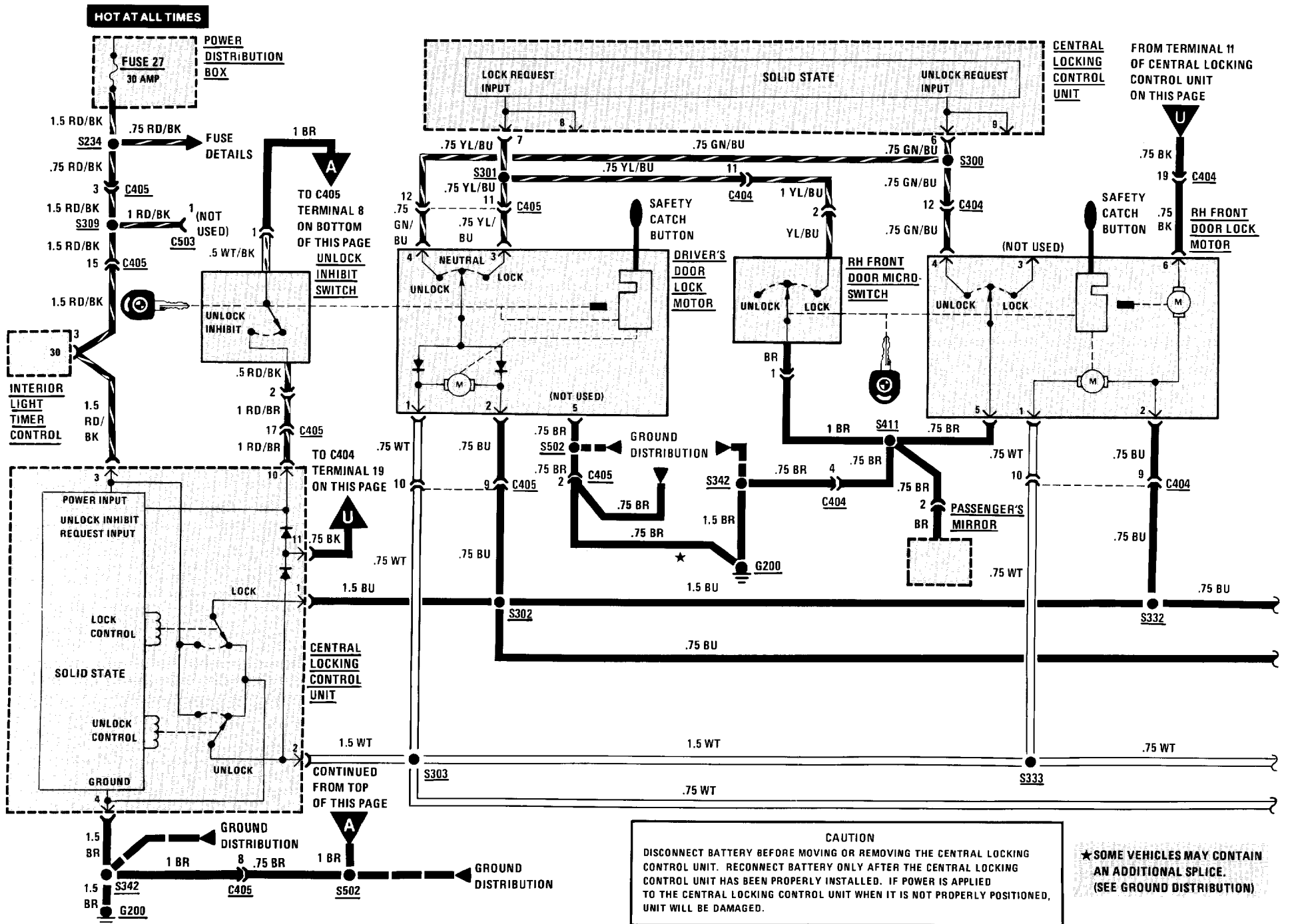

2 DOOR (CONTROL)

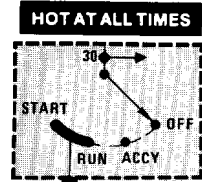

CAUTION
 DO NOT OPERATE THE SYSTEM MORE THAN 8 TIMES IN QUICK SUCCESSION TO PREVENT DAMAGE TO THE CENTRAL LOCKING CONTROL UNIT.

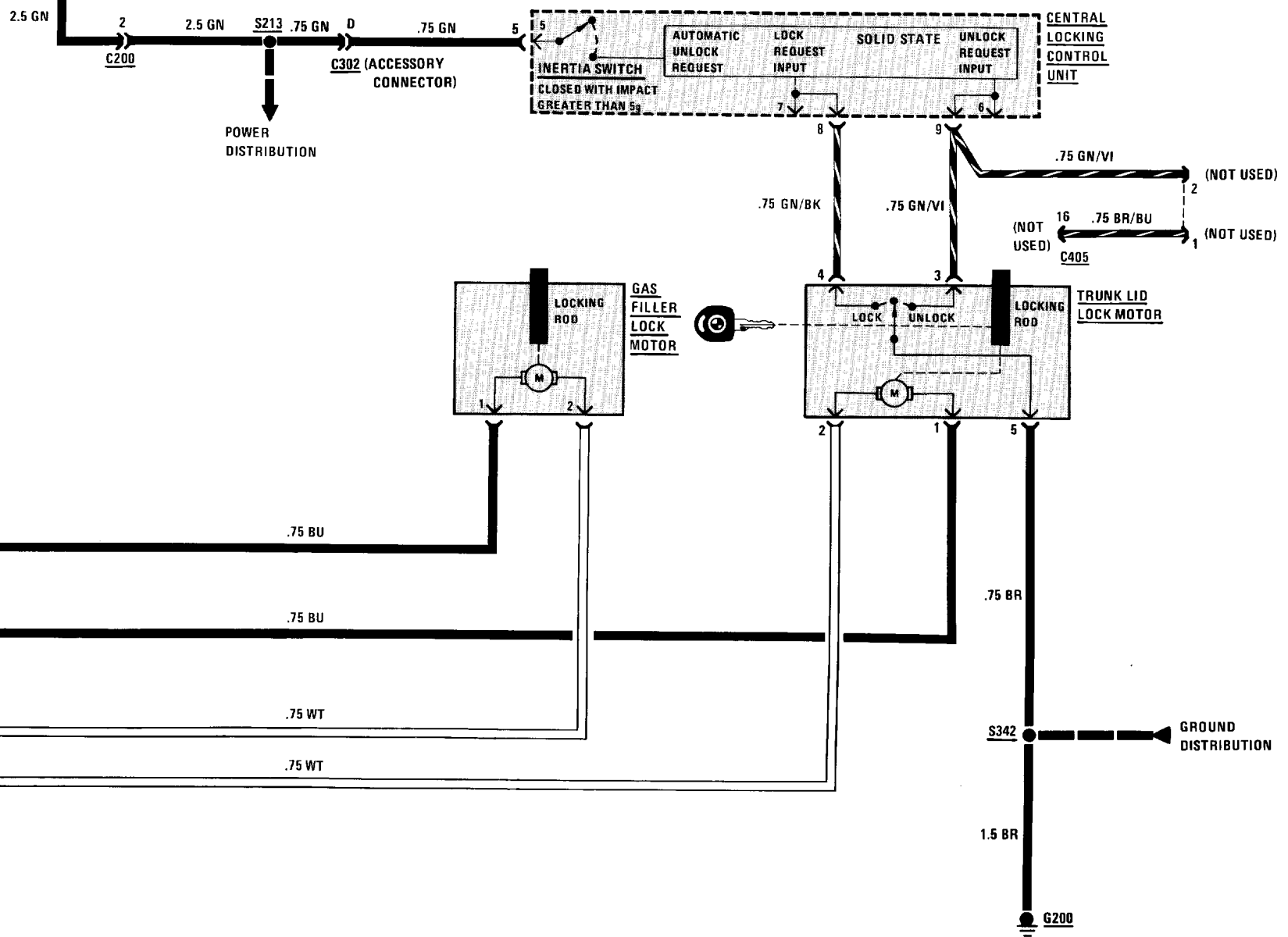

5126-2 CENTRAL LOCKING

4 DOOR (SELECT)

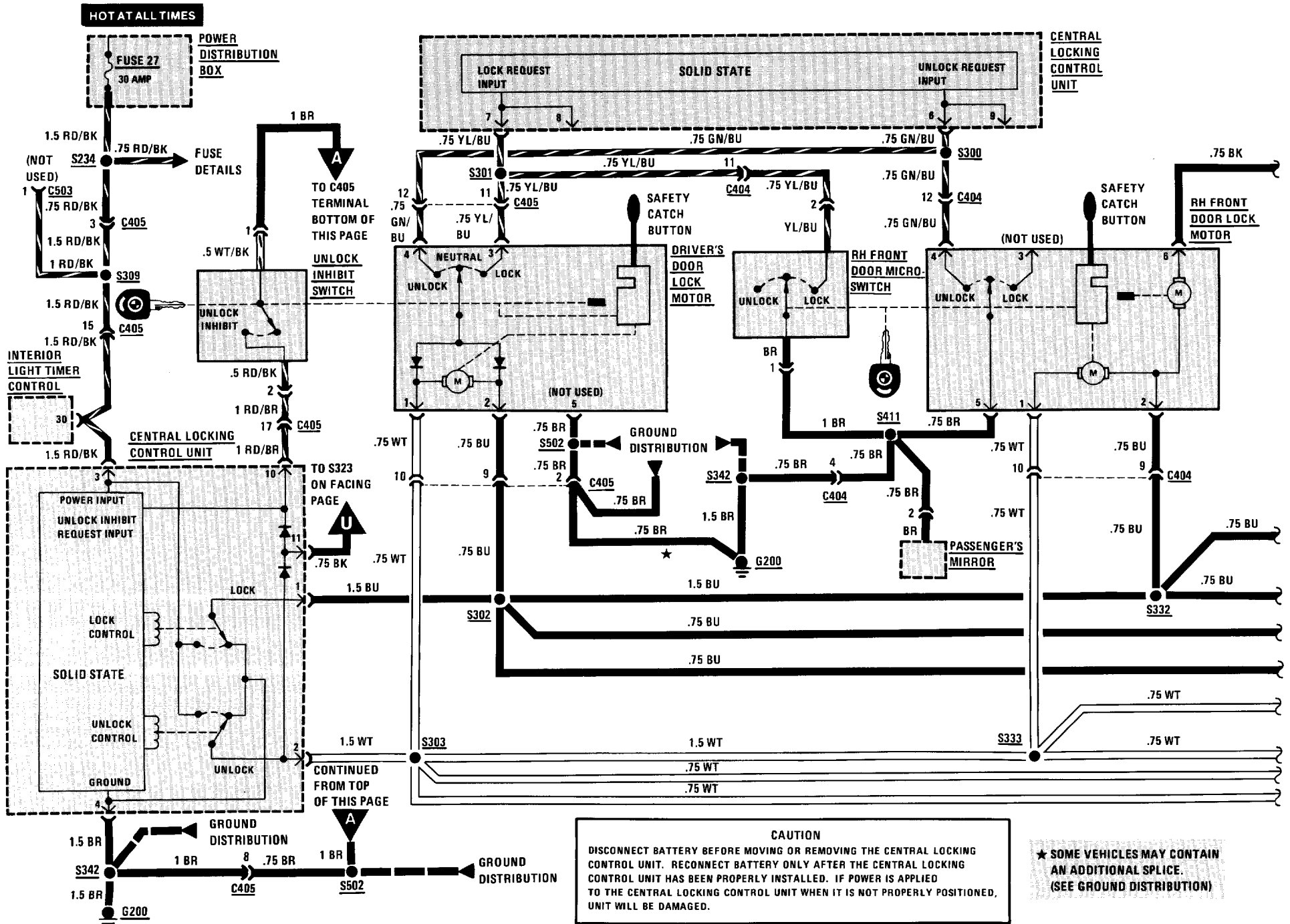

4 DOOR (CONTROL)

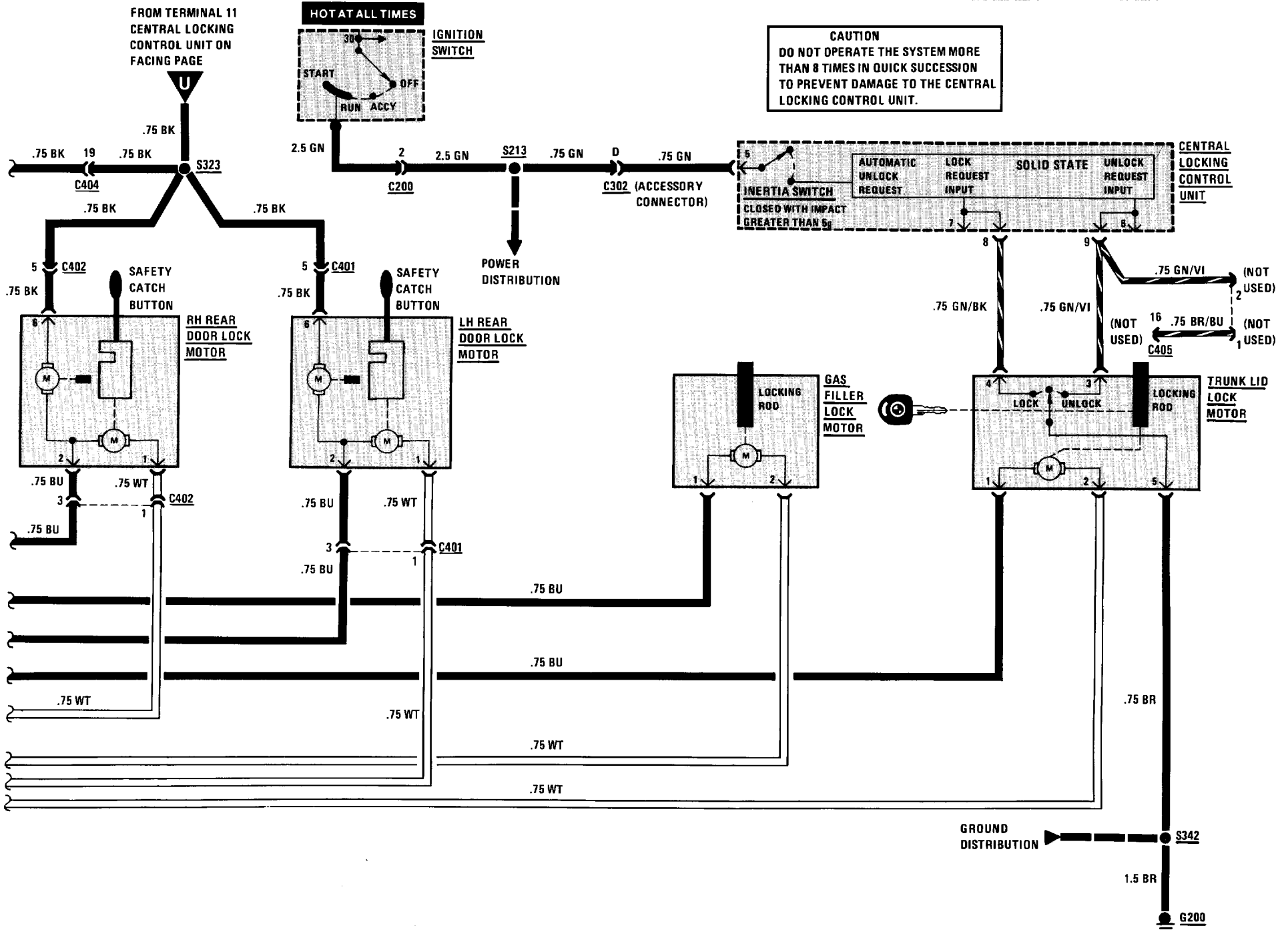

SYSTEM CHECK TABLE (CONT'D)

OPERATION	RESPONSE	REPAIR ACTION
3. Turn the key to UNLOCK	All doors unlock	None, proceed to Operation 4
	Some doors unlock	Repair/replace the suspect Door Lock Motor circuit
	No doors unlock	Proceed to Operation 5
4. Insert the key in the Passenger's door and turn to LOCK	All doors lock	If the doors did not lock in Operation 1, repair/replace the Driver's Door Lock Switch, otherwise proceed to Operation 5
	Some doors lock	Repair/replace the suspect Door Lock Motor circuit
	No doors lock	If all the doors locked in Operation 1, repair/replace the Right Front Door Microswitch. If the doors did not lock in Operation 1, perform Test A
5. Insert the key in the Passenger's door and turn to UNLOCK	All doors unlock	If all the doors did not unlock in Operation 3, repair/replace the Driver's Door Lock Switch, otherwise proceed to Operation 6
	Some doors unlock	Repair/replace the suspect Door Lock Motor
	No doors unlock	If all the doors unlocked in Operation 3, repair/replace the Passenger's Door Lock Switch. If the doors did not unlock in Operation 3, perform Test C
6. Get in the car and close and lock all doors Turn the Ignition Switch to RUN	Doors remain locked	None, proceed to Operation 7
	Doors unlock	Repair/replace the Central Locking Control Unit
7. Get out of the car Insert the key in the Driver's door and turn to LOCK Unlock each of the doors by pulling up the Safety Catch Buttons	All doors can be unlocked	None, proceed to Operation 8
	All doors remain secure	Disconnect the connector from the Central Locking Control Unit and check for a short to ground in the wires at terminal 11. • If short to ground is not present, replace the Central Locking Control Unit. • If short to ground is present isolate wiring from Door Lock Motors one at a time to find short

5126A-2 CENTRAL LOCKING

SYSTEM CHECK TABLE (CONT'D)

OPERATION	RESPONSE	REPAIR ACTION
8. Insert the key in the Trunk Cylinder Switch. Turn the key to LOCK	Trunk locks	None, proceed to Operation 9
	Trunk does not lock	If the doors lock, repair/replace the Trunk Lock Motor Circuit or Trunk Lock Motor If the doors do not lock, repair/replace the Trunk Switch Repair/replace the Central Locking Control Unit if the Trunk Switch Circuit is OK
9. Turn the key to UNLOCK	Trunk unlocks	None, proceed to Operation 10
	Trunk does not unlock	If the doors unlock, repair/replace the Trunk Lock Motor circuit or Trunk Lock Motor If the doors do not unlock, repair/replace the Trunk Switch Repair/replace the Central Locking Control Unit if the Trunk Switch Circuit is OK
10. Turn the key back to LOCK	Gas Filler locks	None, proceed to Operation 11
	Gas Filler does not lock	Repair/replace the Gas Filler Lock Motor circuit
11. Turn the key to UNLOCK	Gas Filler unlocks	None
	Gas Filler does not unlock	Repair/replace the Gas Filler Lock Motor circuit

- If all results are normal, system is OK.

SYSTEM DIAGNOSIS

- Do the following tests when directed by the System Check Table.

A: CONTROL UNIT LOCK TEST (TABLE 1)

Measure: VOLTAGE At: CONTROL UNIT CONNECTOR (Connected)		
Measure Between	Correct Voltage	For Diagnosis
3 & Ground	Battery	See 1
3 & 4	Battery	See 2
<ul style="list-style-type: none"> • If voltages are correct, proceed to Table 2. <ol style="list-style-type: none"> 1. Check wire to terminal 3 for an open. 2. Check wire from terminal 4 for an open to ground (see schematic). 		

A: CONTROL UNIT LOCK TEST (TABLE 2)

Connect: A FUSED JUMPER At: CONTROL UNIT CONNECTOR (Connected)		
Jumper Between	Correct Result	For Diagnosis
7 & Ground	Doors lock	See 1
<ul style="list-style-type: none"> • If the result is correct, repair/replace the switches and related wiring (see schematic). <ol style="list-style-type: none"> 1. Proceed to Table 3. 		

**A: CONTROL UNIT LOCK TEST
(TABLE 3)**

Connect: FUSED JUMPERS At: CONTROL UNIT CONNECTOR (Disconnected)		
Jumper Between	Correct Result	For Diagnosis
1 & 3 2 & 4	Doors lock	See 1
<ul style="list-style-type: none"> If the result is correct, replace the Central Locking Control Unit. <ol style="list-style-type: none"> Check wire from terminal 1 to splice and wire from terminal 3 to splice for opens (see schematic). 		

B: UNLOCK INHIBIT TEST

Connect: A FUSED JUMPER At: CONTROL UNIT CONNECTOR (Connected)		
Jumper Between	Correct Result	For Diagnosis
10 & Ground	Doors double lock	See 1
<ul style="list-style-type: none"> If the result is correct, check wires from terminal 10 to ground for opens (see schematic). Replace the Unlock Inhibit Switch if the wires and connections are OK. <ol style="list-style-type: none"> Check wires from terminal 11 for opens (see schematic). Replace the Central Locking Control Unit if wires and connections are OK. 		

C: CONTROL UNIT UNLOCK TEST

Connect: A FUSED JUMPER At: CONTROL UNIT CONNECTOR (Connected)		
Jumper Between	Correct Result	For Diagnosis
6 & Ground	Doors unlock	See 1
<ul style="list-style-type: none"> If the result is correct, repair/replace the switches and related wiring (see schematic). <ol style="list-style-type: none"> Replace Central Locking Control Unit. 		

CIRCUIT DESCRIPTION

The Central Locking System is controlled by the Central Locking Control Unit. This unit senses when a lock switch is moved by a key, and sends the appropriate signal to drive the Motors. The Central Locking Control Unit controls the Door Locks, Gas Filler Lock and Trunk Lock. The unit also has an Inertia Switch which closes on impact greater than 5g. If in RUN or START, the locks are then unlocked.

Lock

When the Key is inserted into a lock and turned clockwise, the Lock Switch moves to LOCK and grounds terminal 7 of the Central Locking Control Unit. The unit then activates the Lock Relay and applies voltage from Fuse 27 to the Lock Motor, which is grounded through Central Locking Control Unit terminal 2. The Lock Motor then pulls the lock down. The door locks also control the Trunk Lock and Gas Filler Lock.

Unlock

When the key is turned counterclockwise, terminal 6 of the Central Locking Control Unit is grounded through the Lock Switch. The Central Locking Control Unit activates the Unlock Relay and applies voltage from Fuse 27, through terminal 2 to the Lock Motor. The motor is grounded through the BU wire, Central Locking Control Unit terminal 1. The polarity is reversed and the motor pushes the lock up.

Unlock Inhibit

When the key is inserted into the Driver's Lock and turned clockwise past the LOCK position, the Unlock Inhibit mechanism is engaged. Mechanically inserting a bar into the driver's lock prevents unlocking through use of the Safety Catch Button. When in the Unlock Inhibit position, ground is applied to the Unlock Inhibit motors in the other lock units. The Central Locking Control Unit is grounded at terminal 10 and then activates the Lock Relay. Voltage is applied to the Unlock Inhibit motors through terminal 1. They are activated and engage the other Unlock Inhibit mechanisms. The direction of the motors is reversed when the doors are unlocked (see Unlock).

Trunk Lock

The Trunk Lock operates in a manner similar to the Door Locks.

5133-0 POWER WINDOWS

4 DOOR

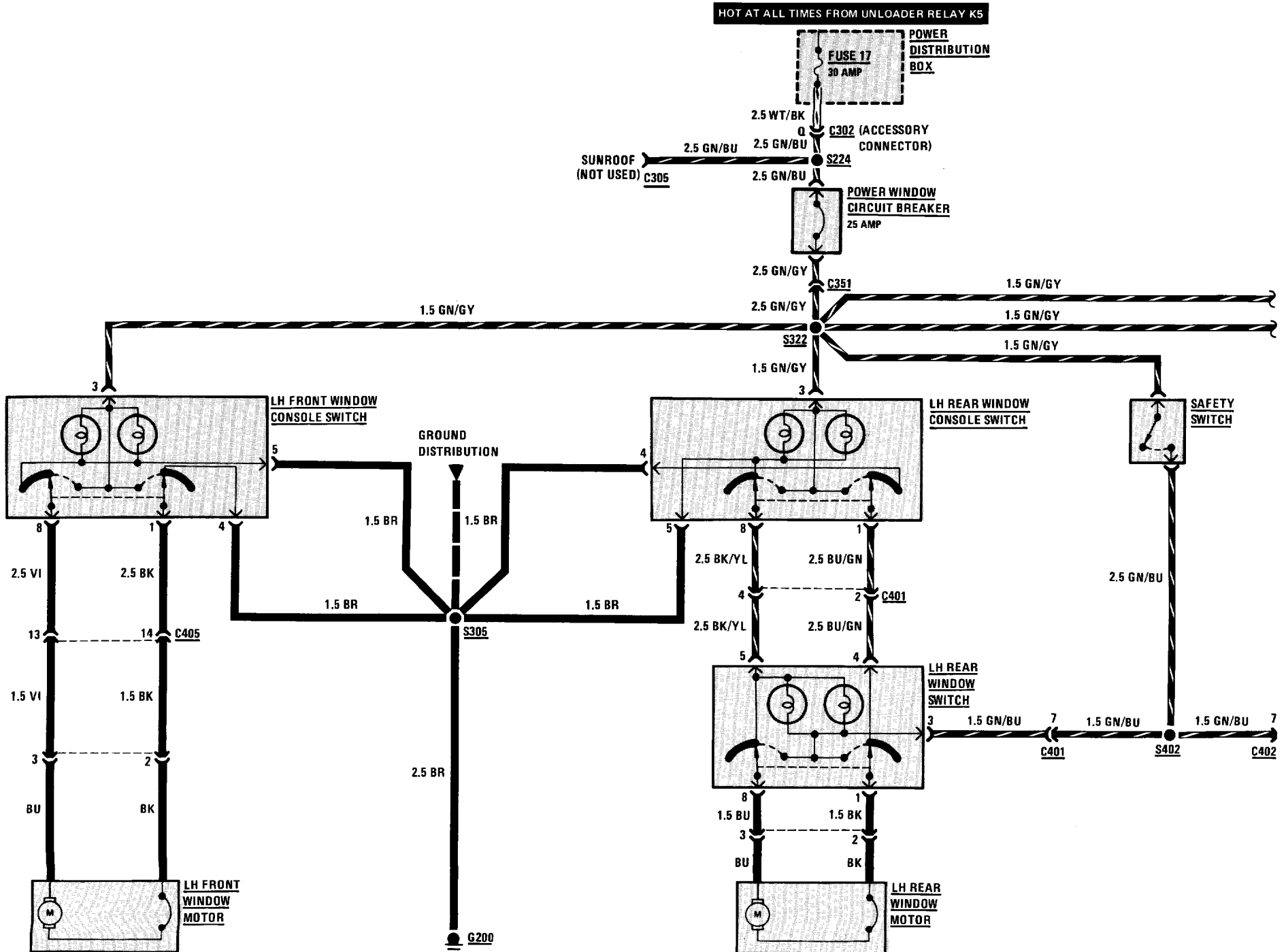

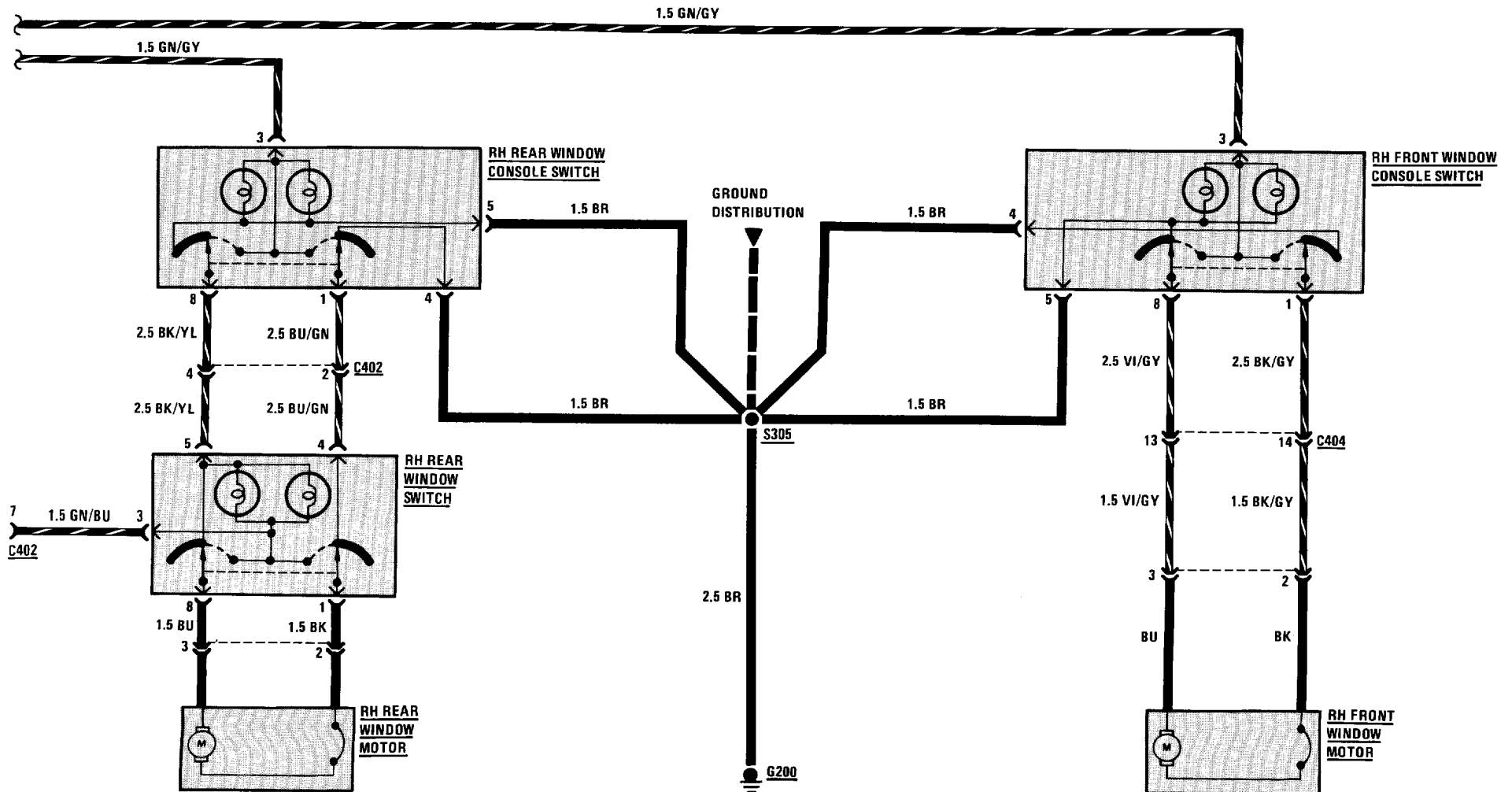

5133-2 POWER WINDOWS

2 DOOR

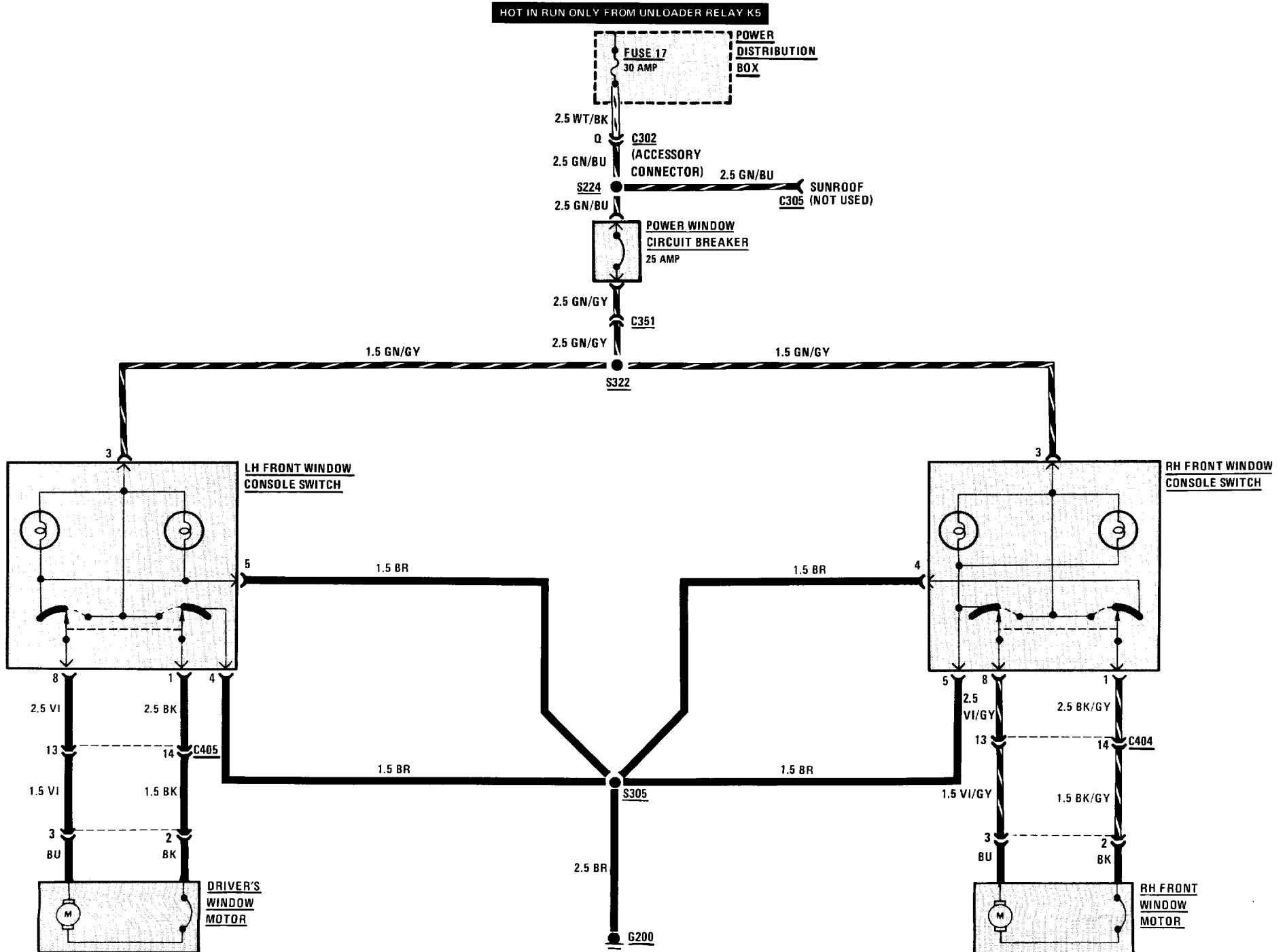

5200-0 SEATS

HEATED SEATS

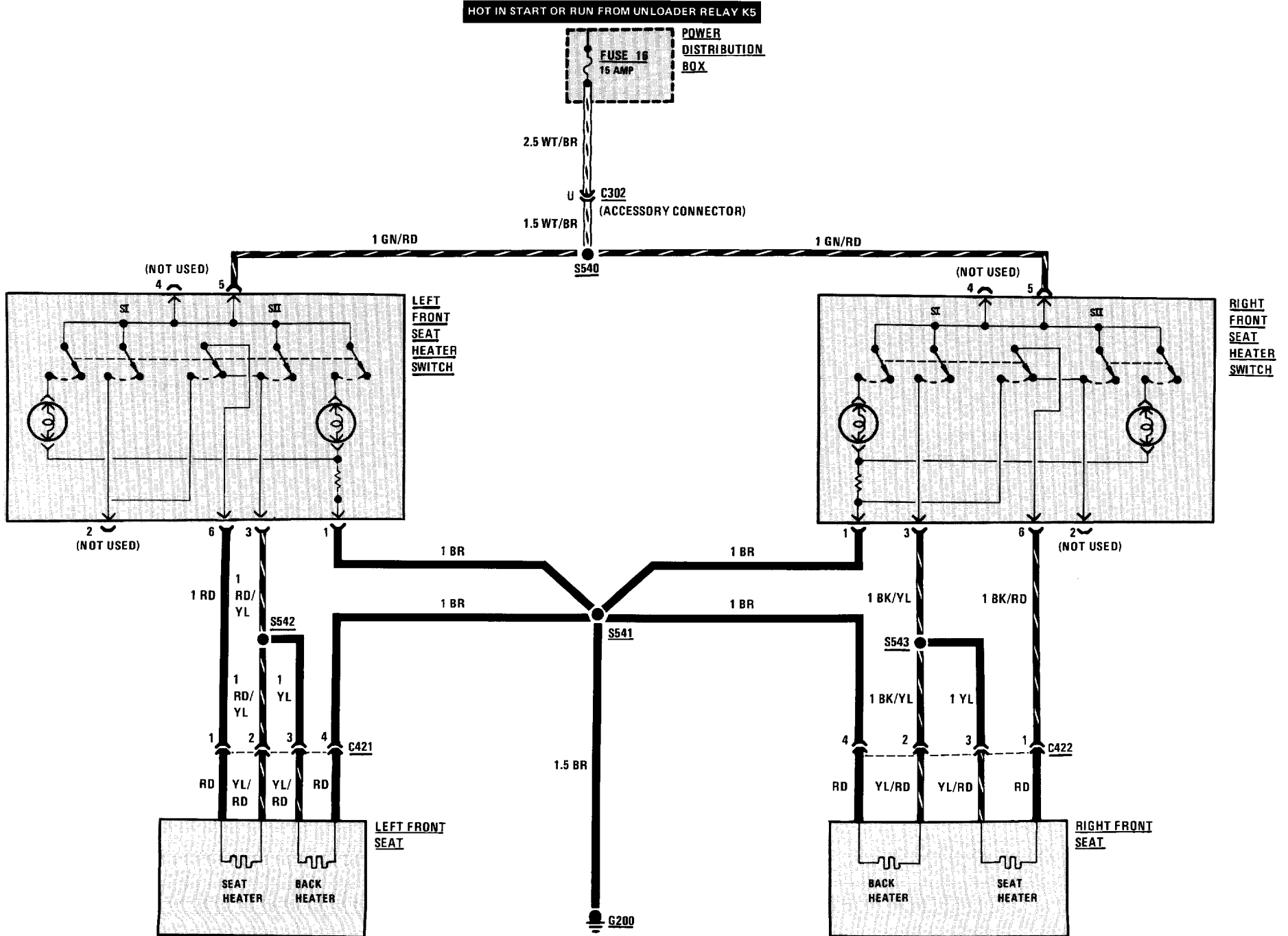

HORNS

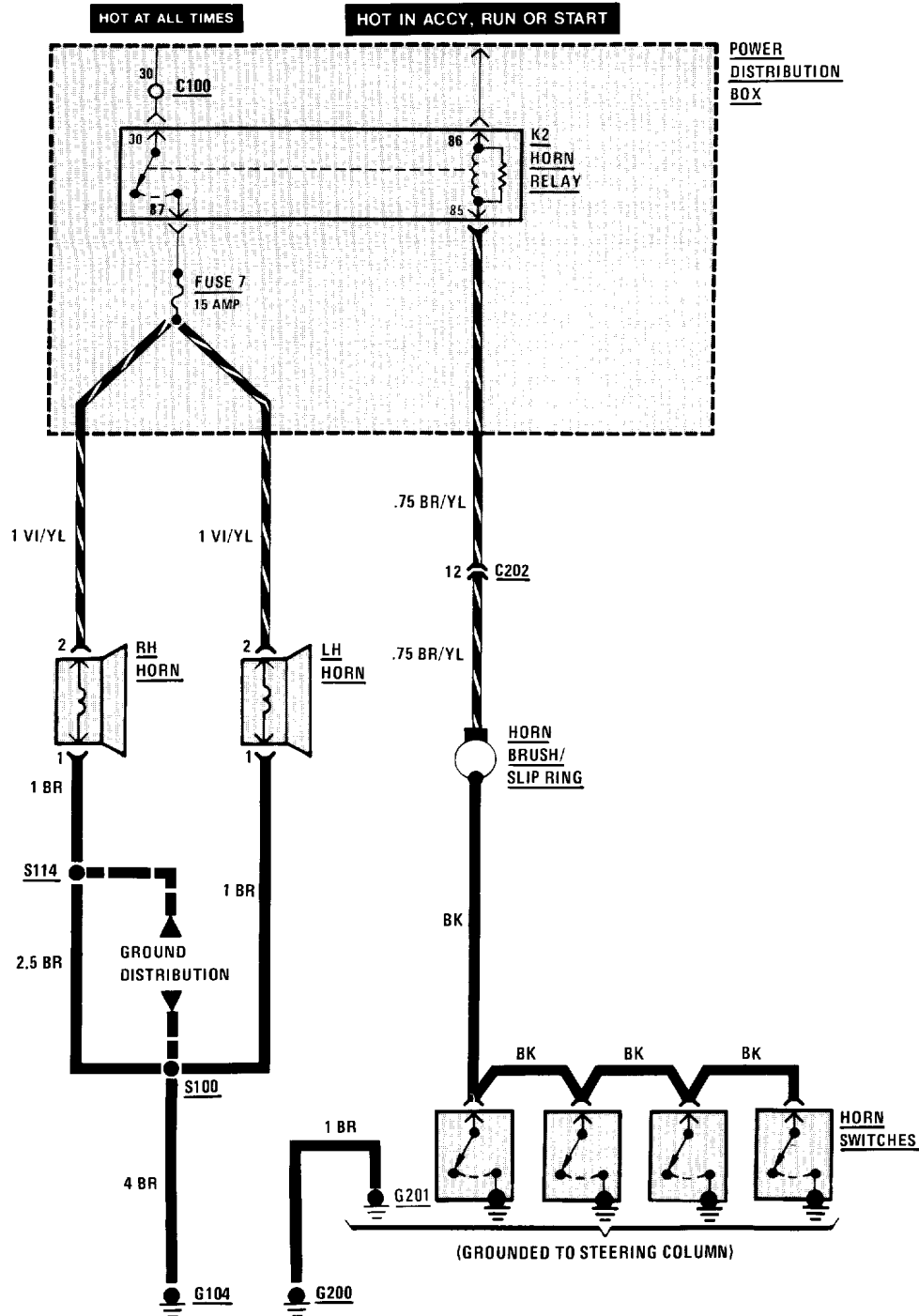

CIGAR LIGHTER/GLOVE BOX LIGHT/AUTO-CHARGING FLASHLIGHT/MAP READING LIGHT

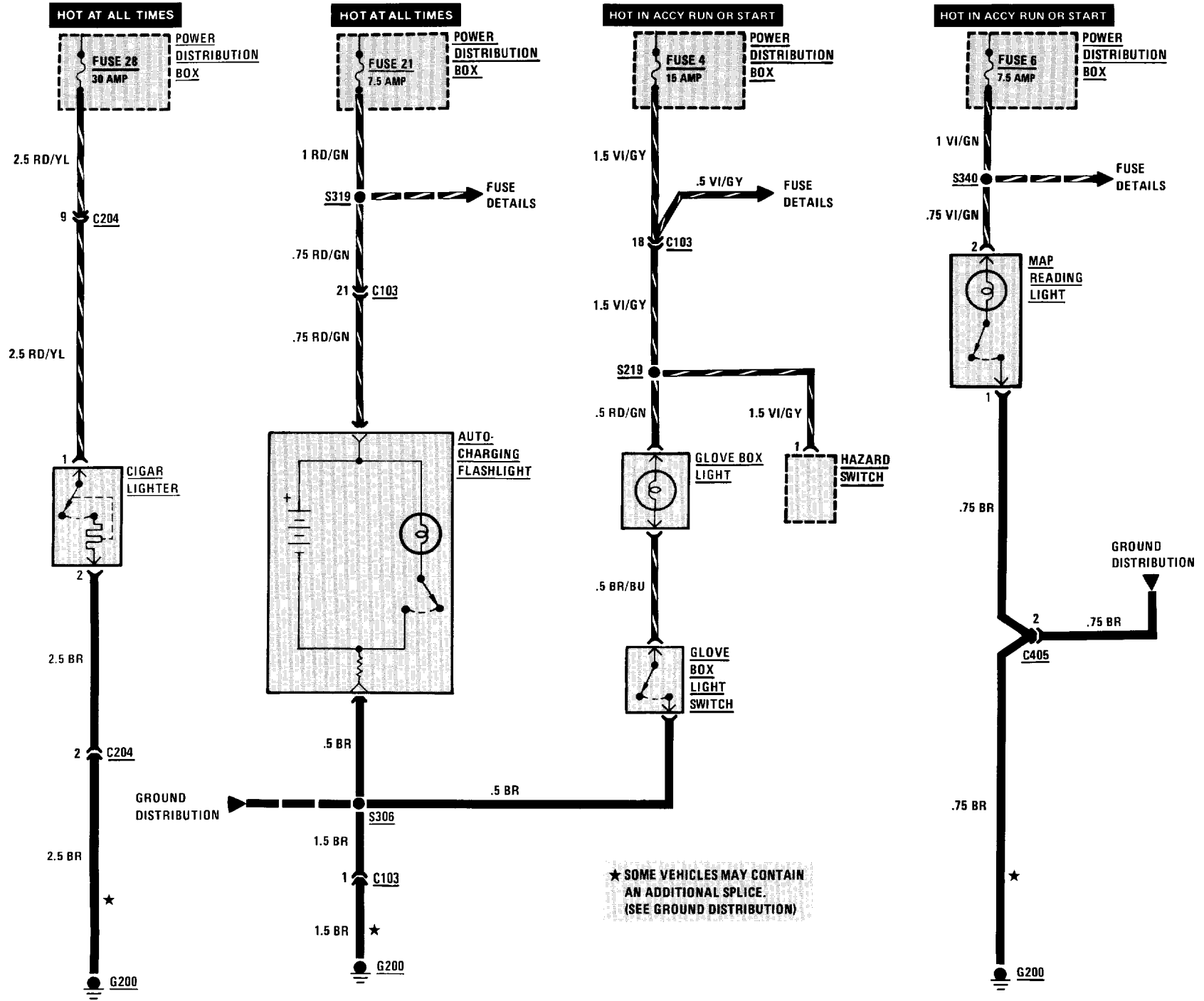

6100-2 BODY ELECTRICAL

REAR DEFOGGER

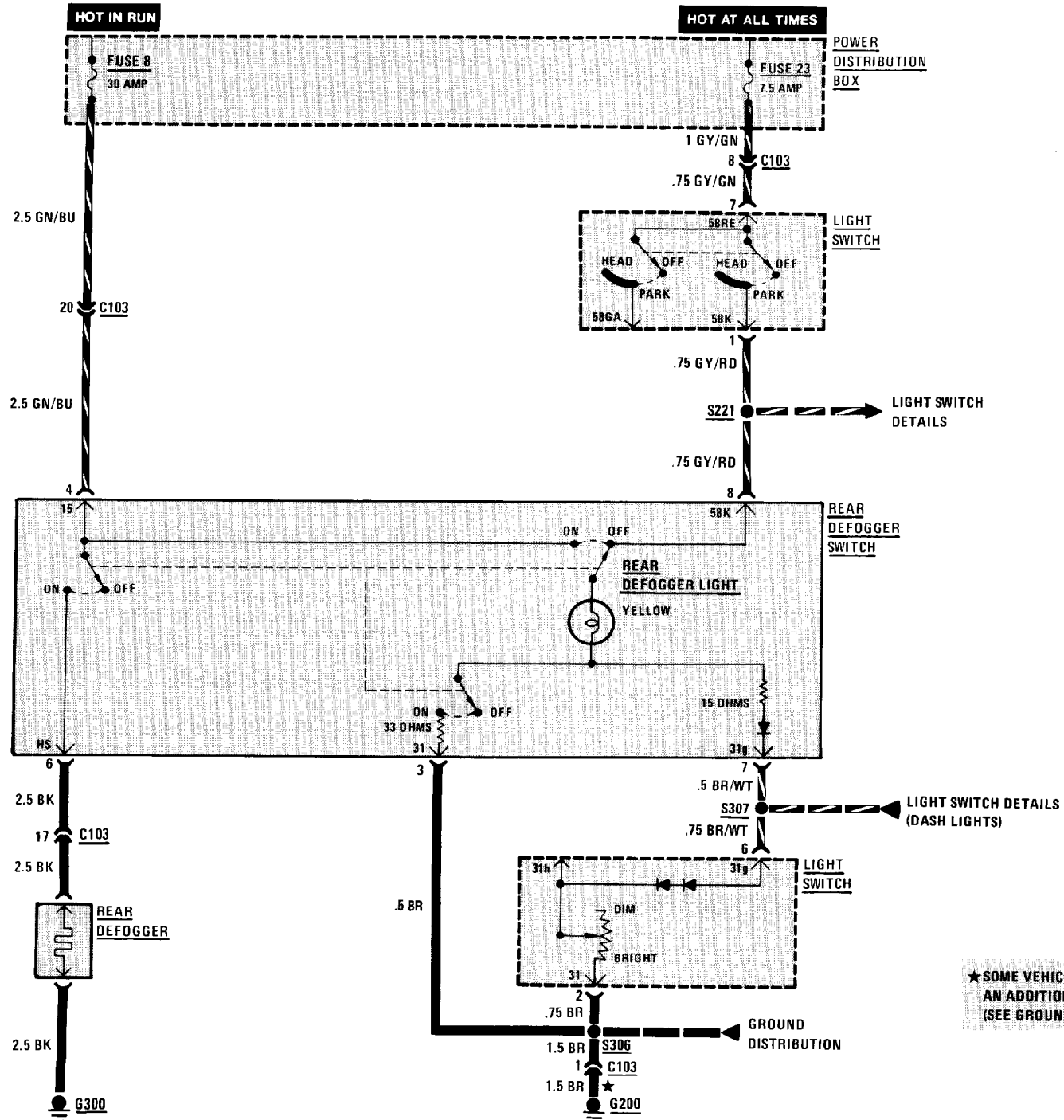

★ SOME VEHICLES MAY CONTAIN AN ADDITIONAL SPLICE (SEE GROUND DISTRIBUTION)

6131-0 IGNITION KEY WARNING/SEATBELT WARNING

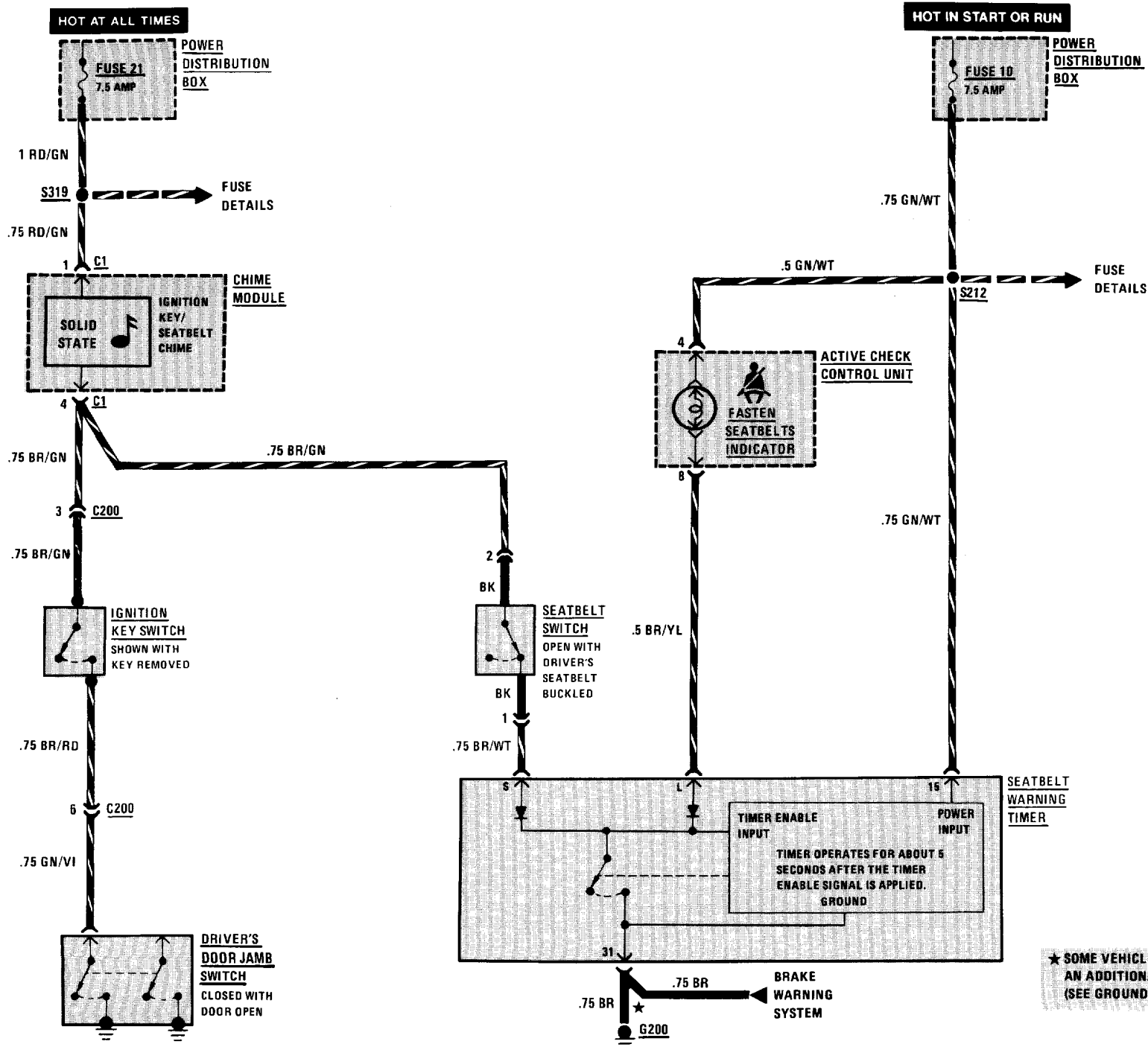

★ SOME VEHICLES MAY CONTAIN AN ADDITIONAL SPLICE. (SEE GROUND DISTRIBUTION)

6160-0 WIPER/WASHER

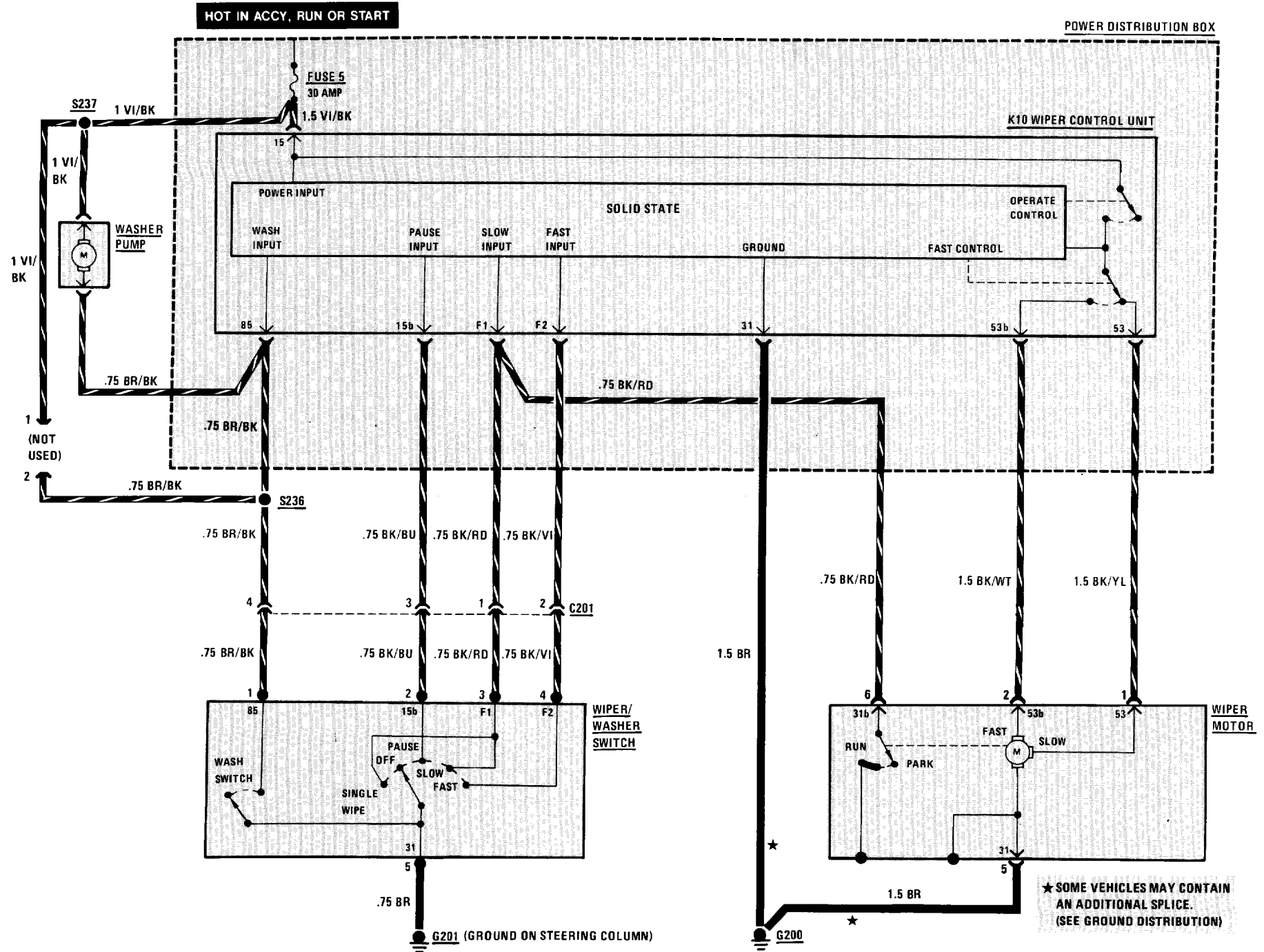

6210-0 INSTRUMENT CLUSTER

SPEEDOMETER/INDICATORS

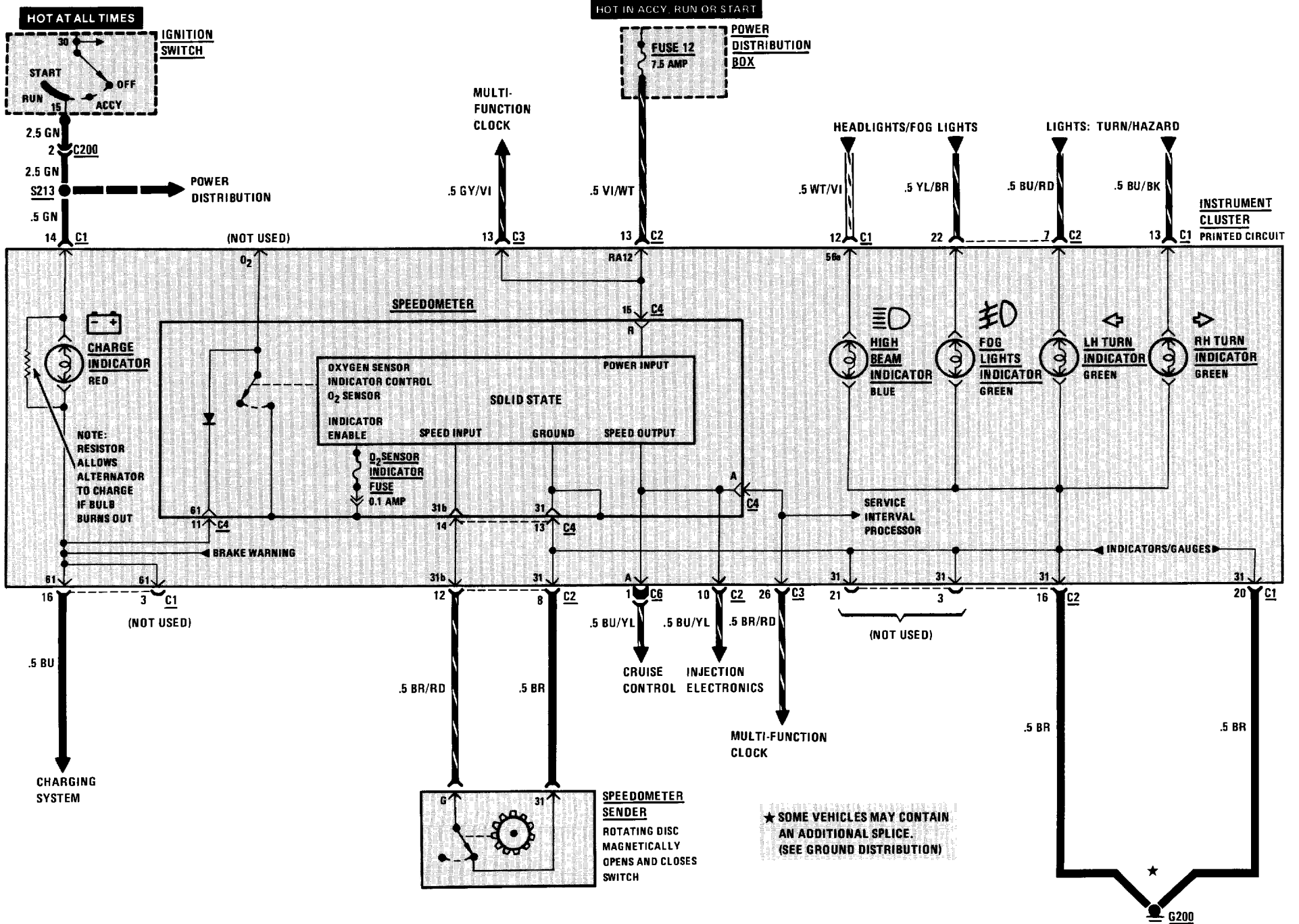

GAUGES/INDICATOR

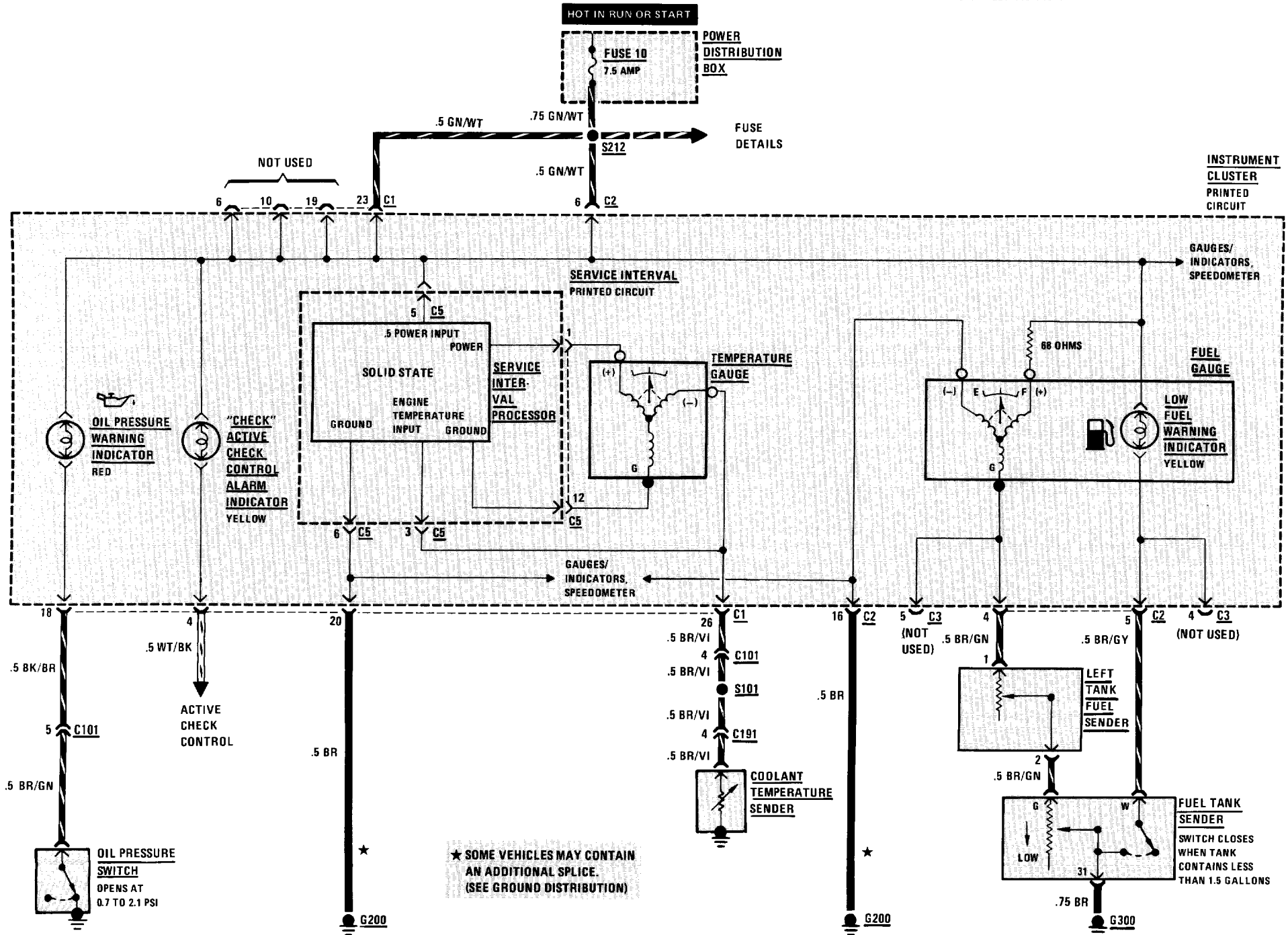

6210-2 INSTRUMENT CLUSTER

SERVICE INTERVAL INDICATOR

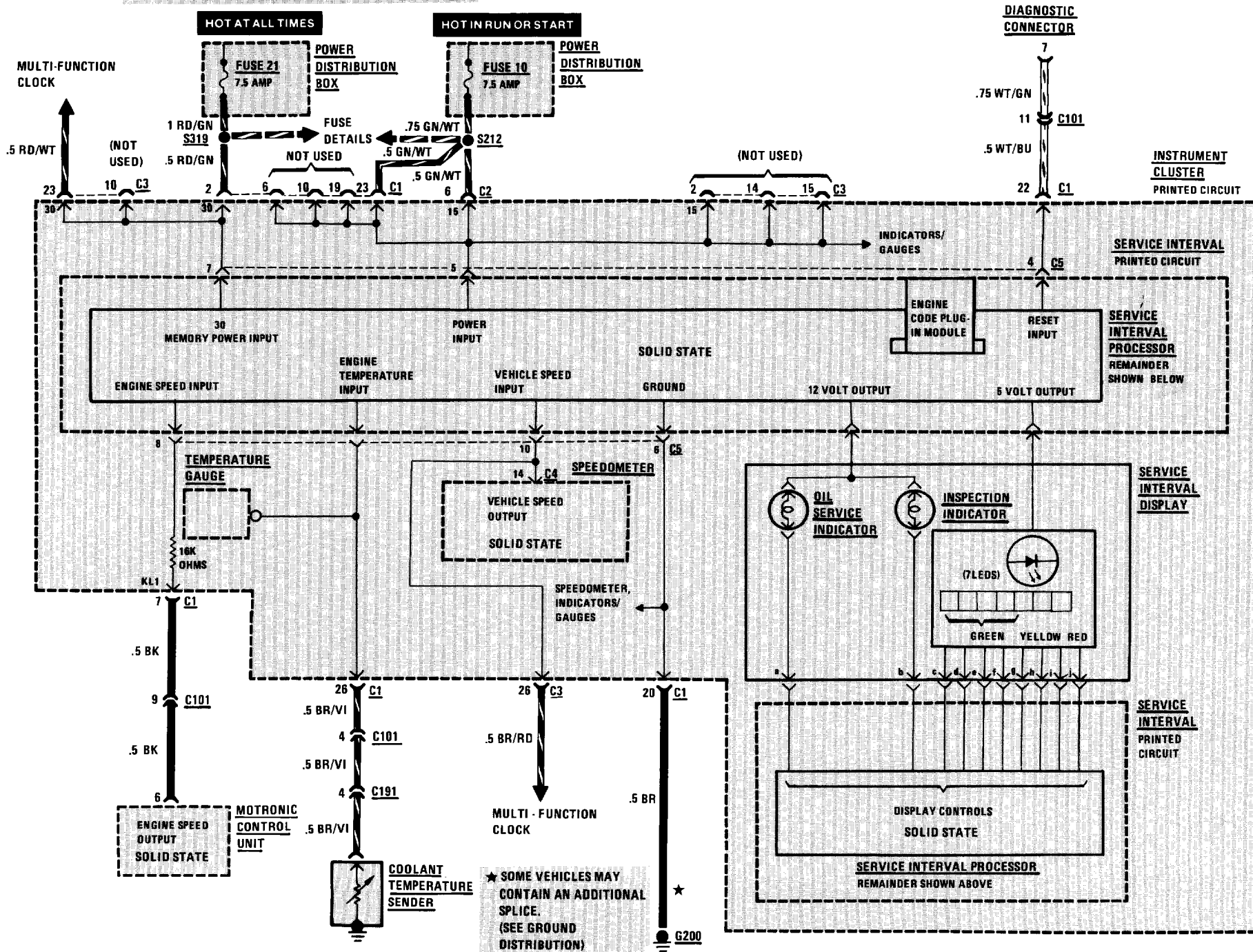

TACHOMETER/FUEL ECONOMY GAUGE

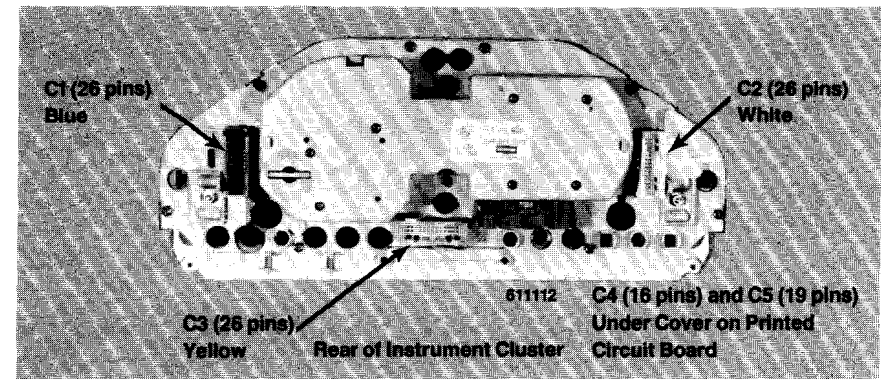
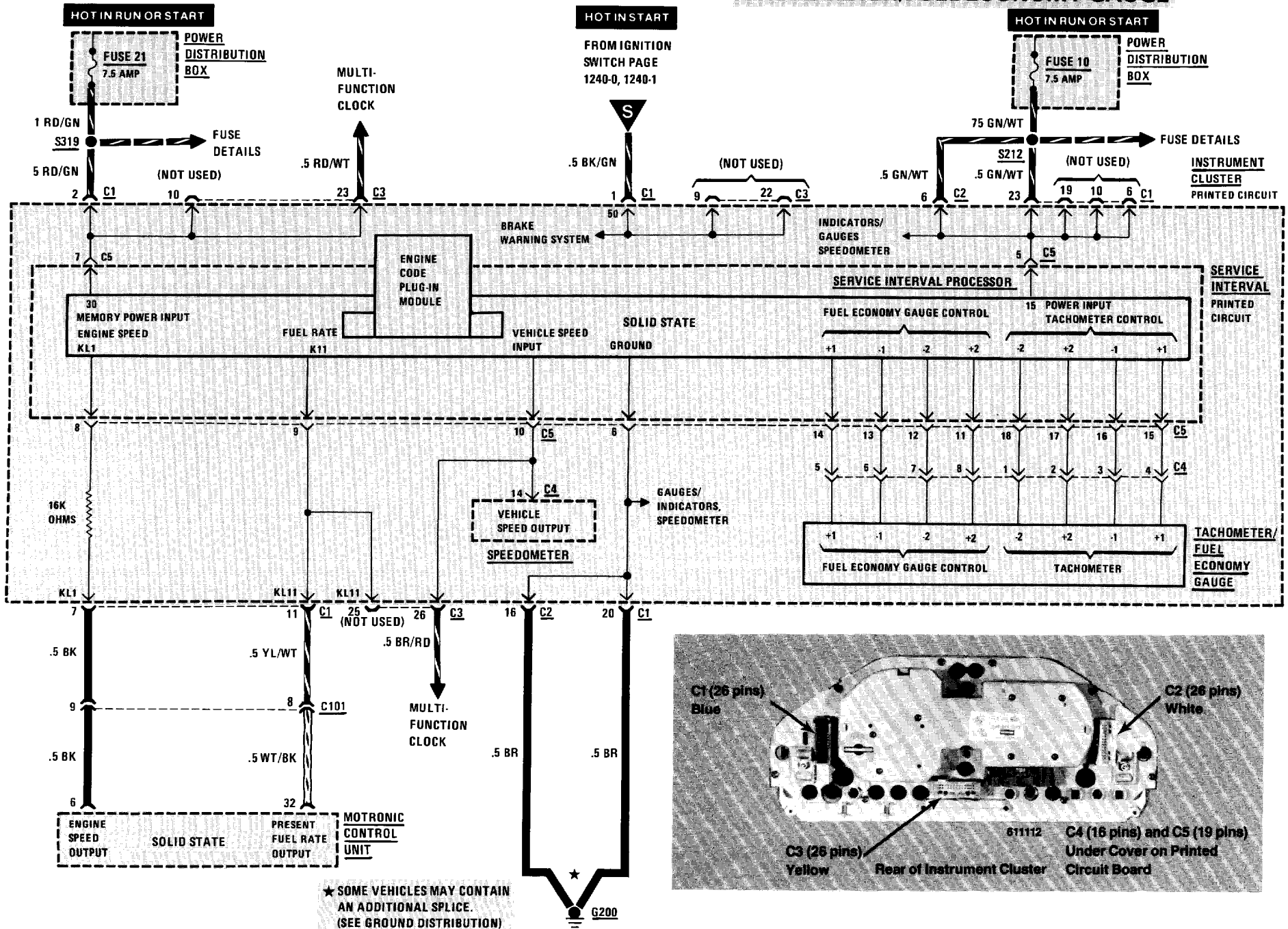

ACTIVE CHECK CONTROL

1. When the Ignition Switch is initially placed in "Run," the Active Check Control Arm Indicator flashes, and the Active Check Control Unit Brake Light LED and panel light illuminate for test purposes. Depressing the brake pedal clears the display.
2. When the Ignition Switch is placed in "RUN," fault monitoring begins. To monitor the low beams, rear lights, or license lights, those circuits must be on. The brake lights are monitored only while the brake pedal is depressed. An exception to this is when all brake light circuits are open. A fault will be indicated with the Ignition Switch in "RUN."
3. When a fault occurs, the alarm indicator flashes, the appropriate LED fault indicator lights, and the panel light goes on for five seconds. Depressing the test button will clear the alarm indicator, but the LED fault indicator remains on.
4. To test the unit, depress the test button. The LED fault indicators and the panel lights should go on.

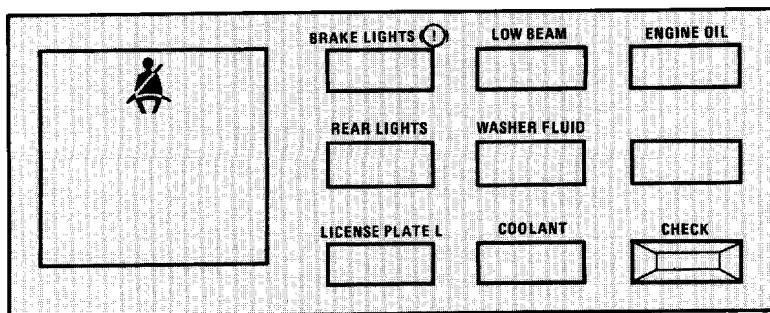
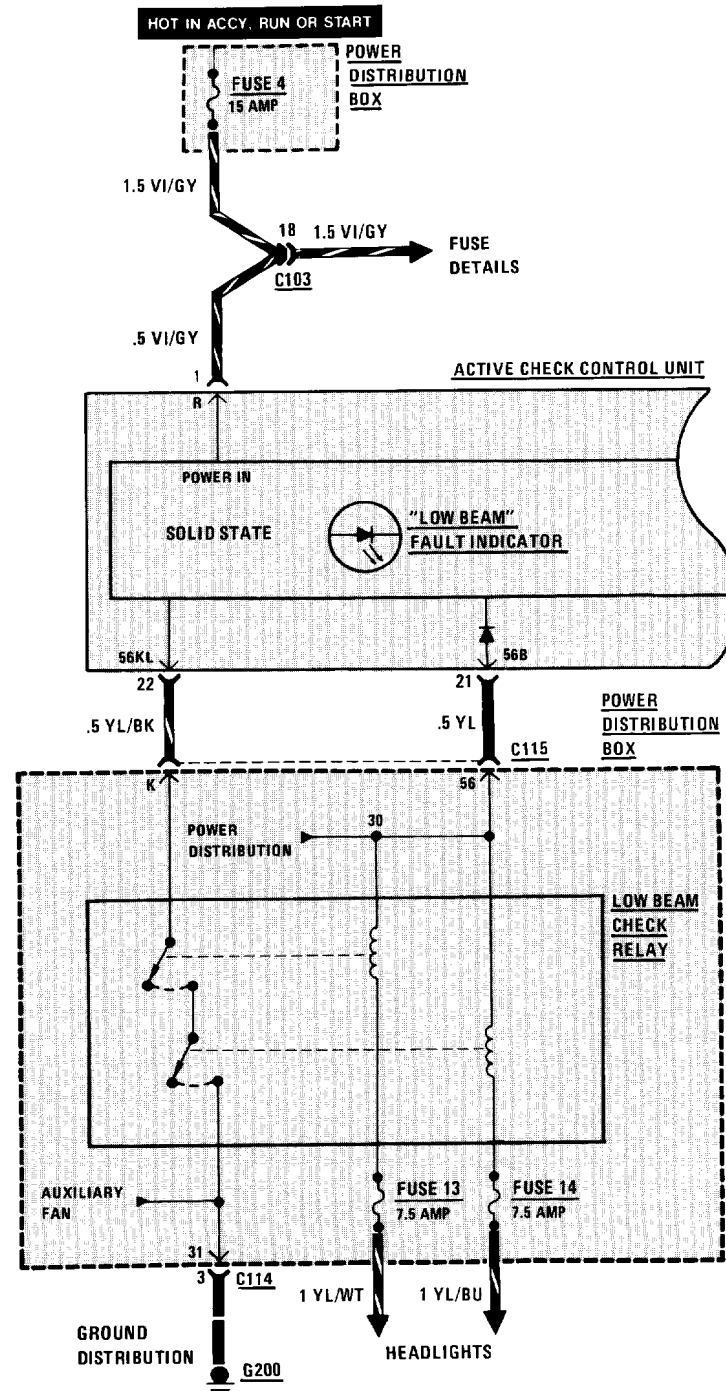
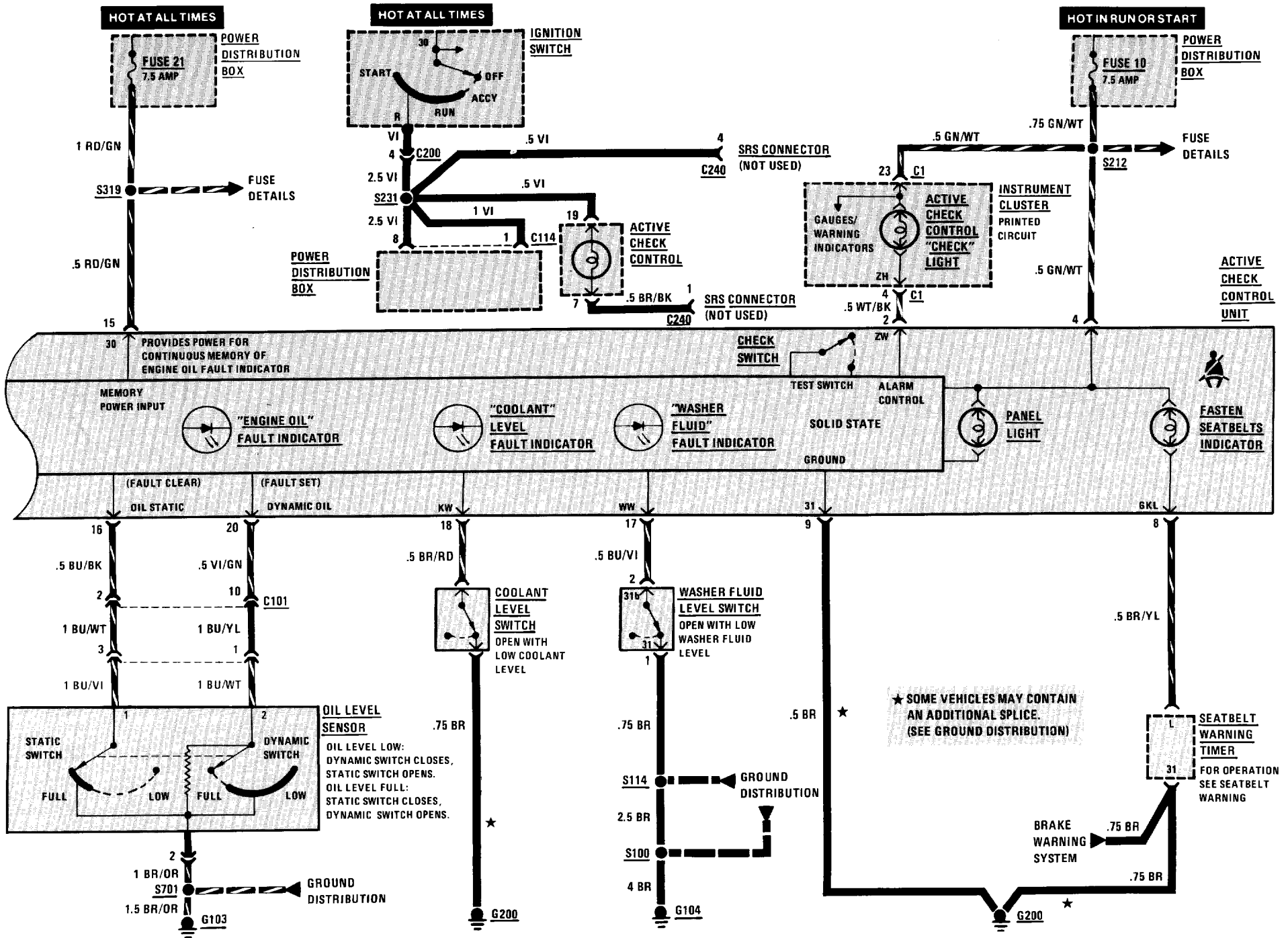

Figure 1 - Active Check Control Unit Above Rear View Mirror



6216-2 ACTIVE CHECK CONTROL



DASH LIGHTS

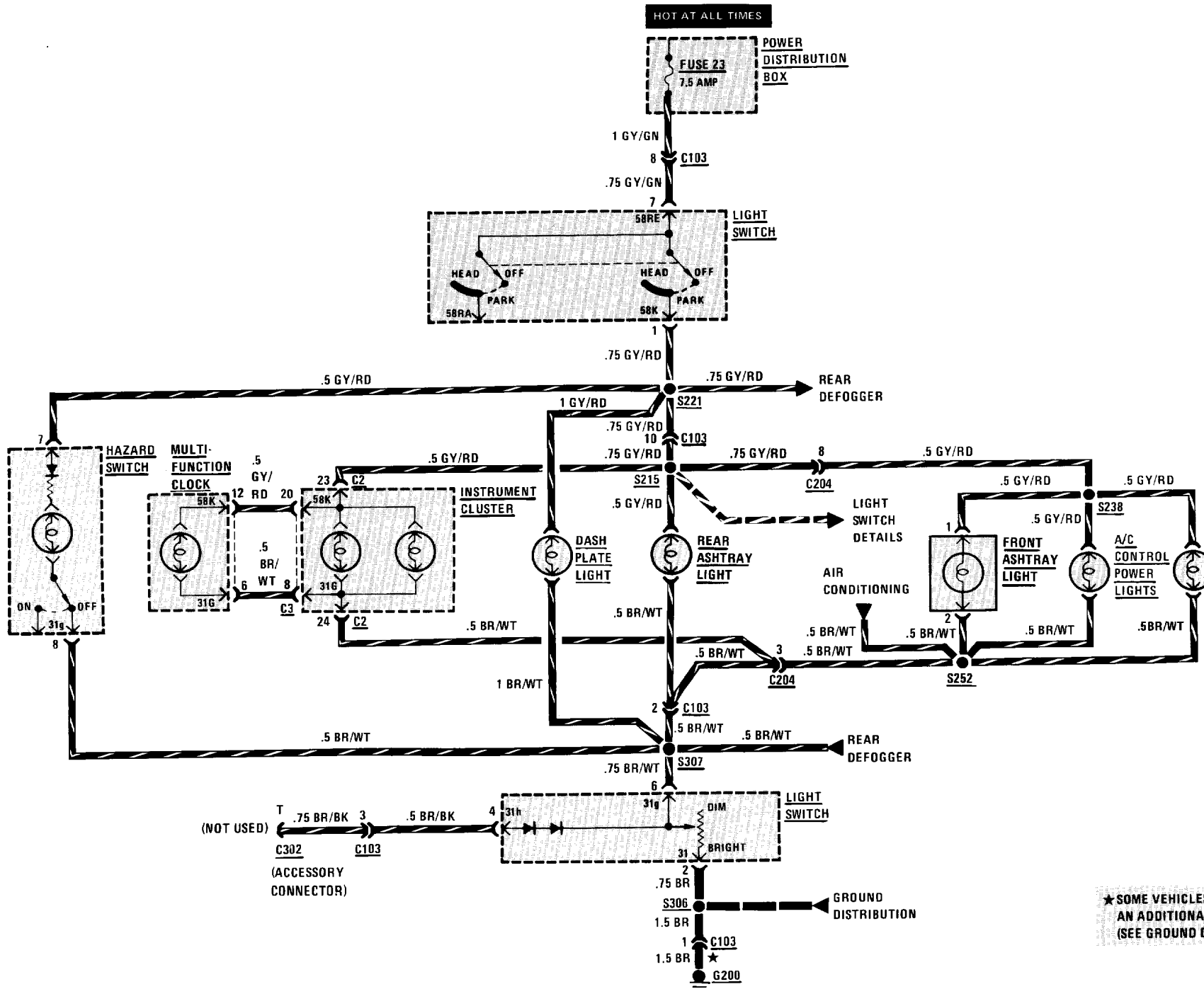

★ SOME VEHICLES MAY CONTAIN AN ADDITIONAL SPLICE. (SEE GROUND DISTRIBUTION)

6312-0 HEADLIGHTS/FOG LIGHTS

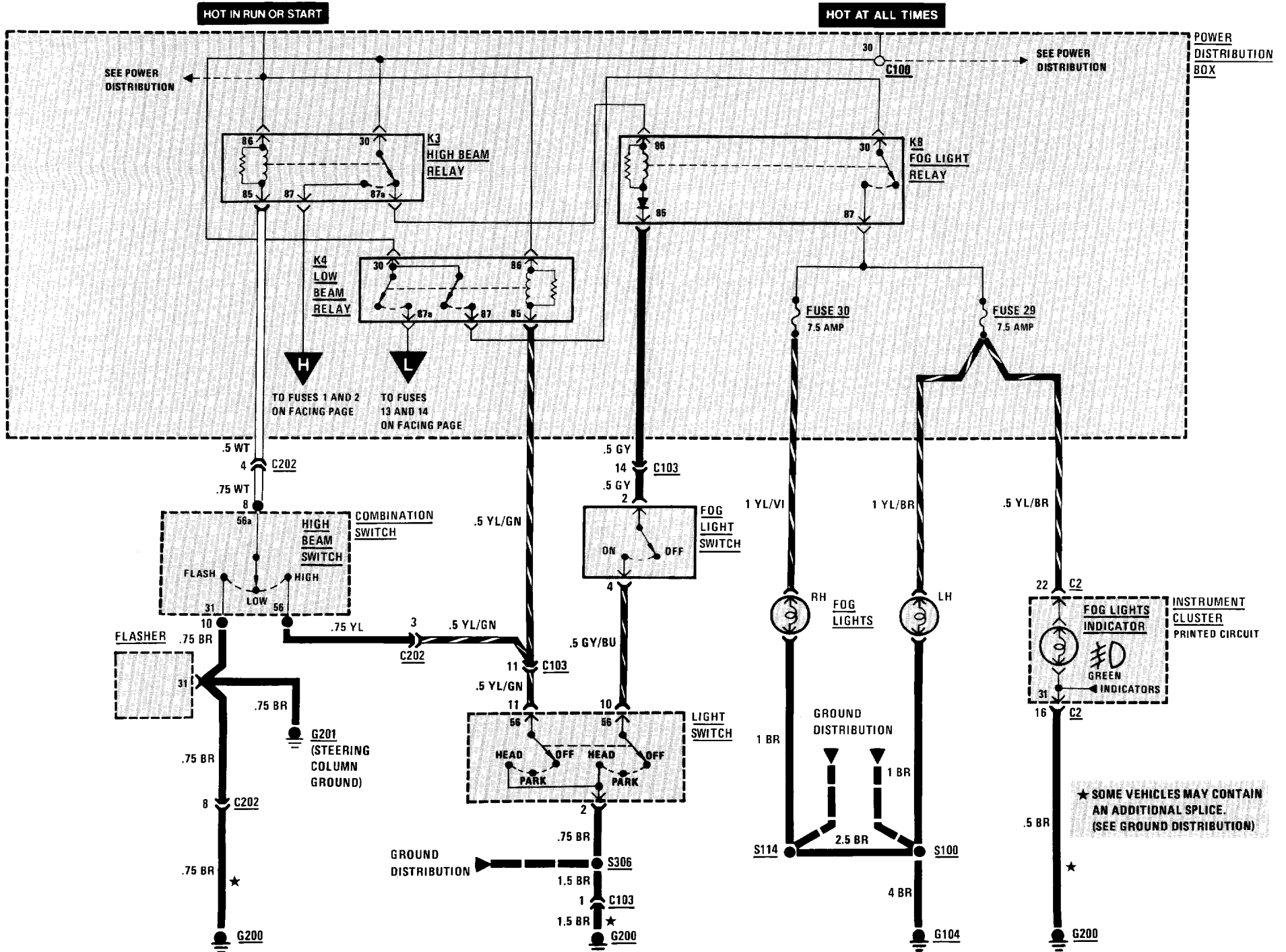

HEADLIGHTS/FOG LIGHTS 6312-1

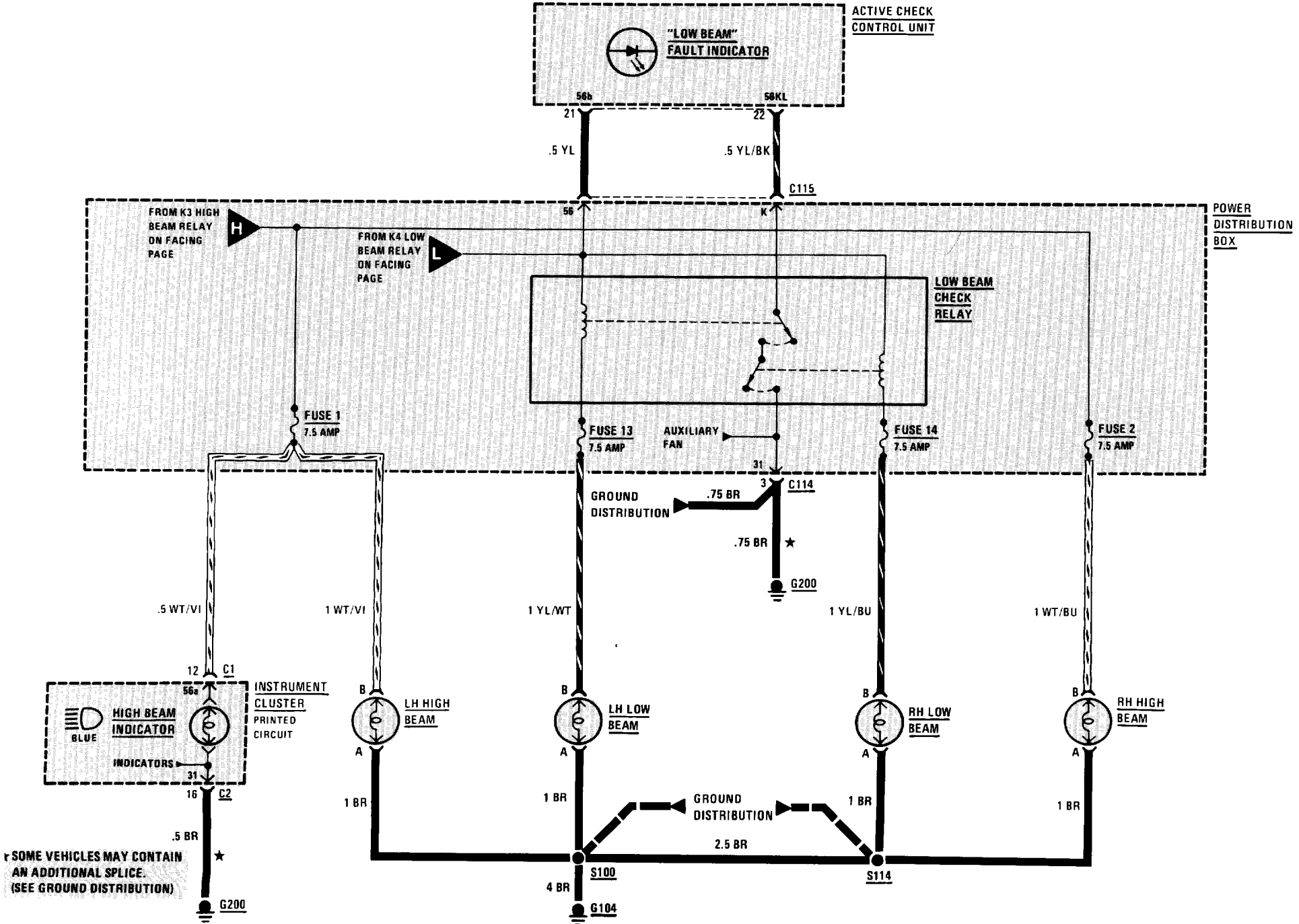

SOME VEHICLES MAY CONTAIN AN ADDITIONAL SPLICE. (SEE GROUND DISTRIBUTION)

6313-0 TURN/HAZARD LIGHTS

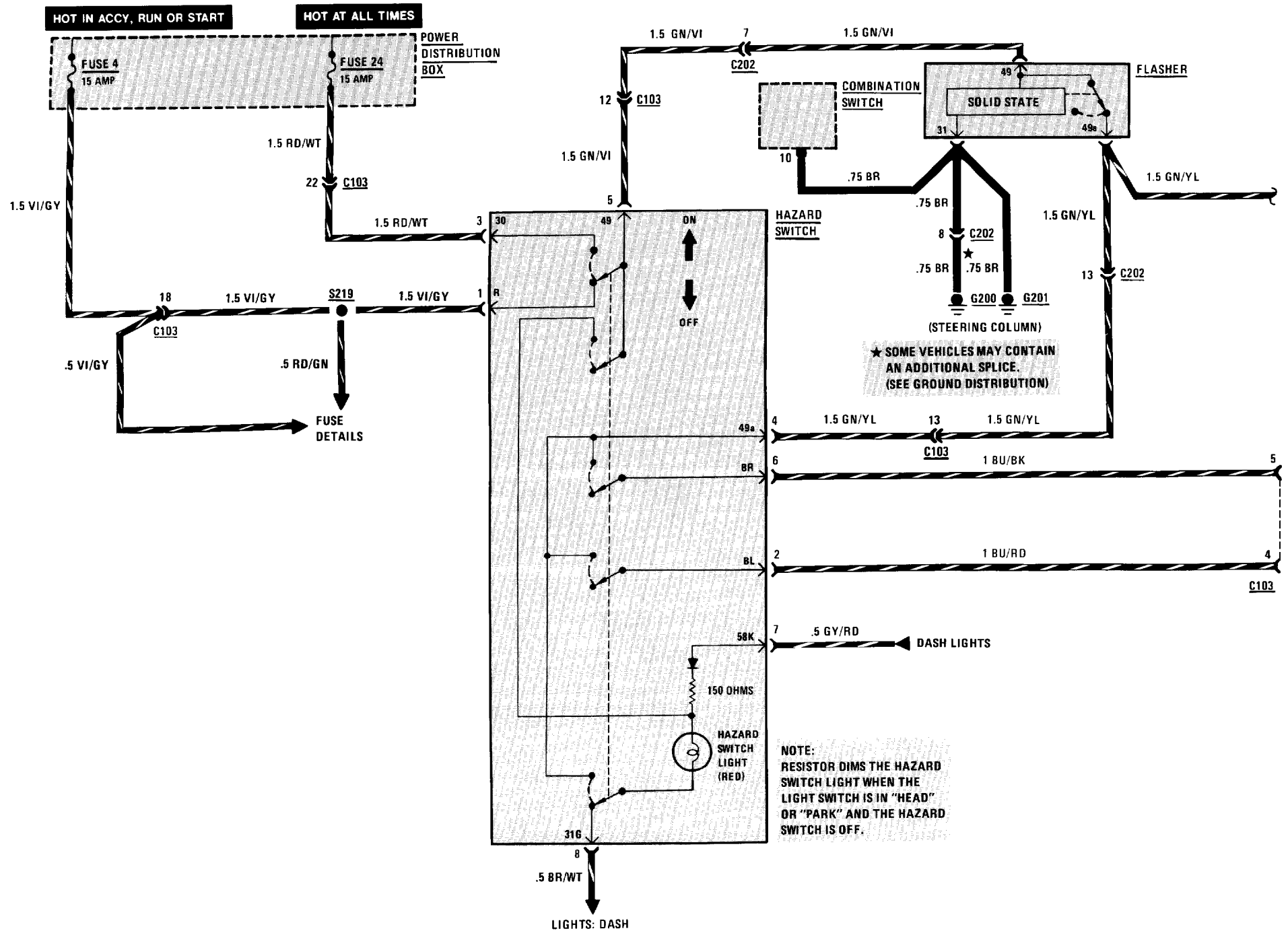

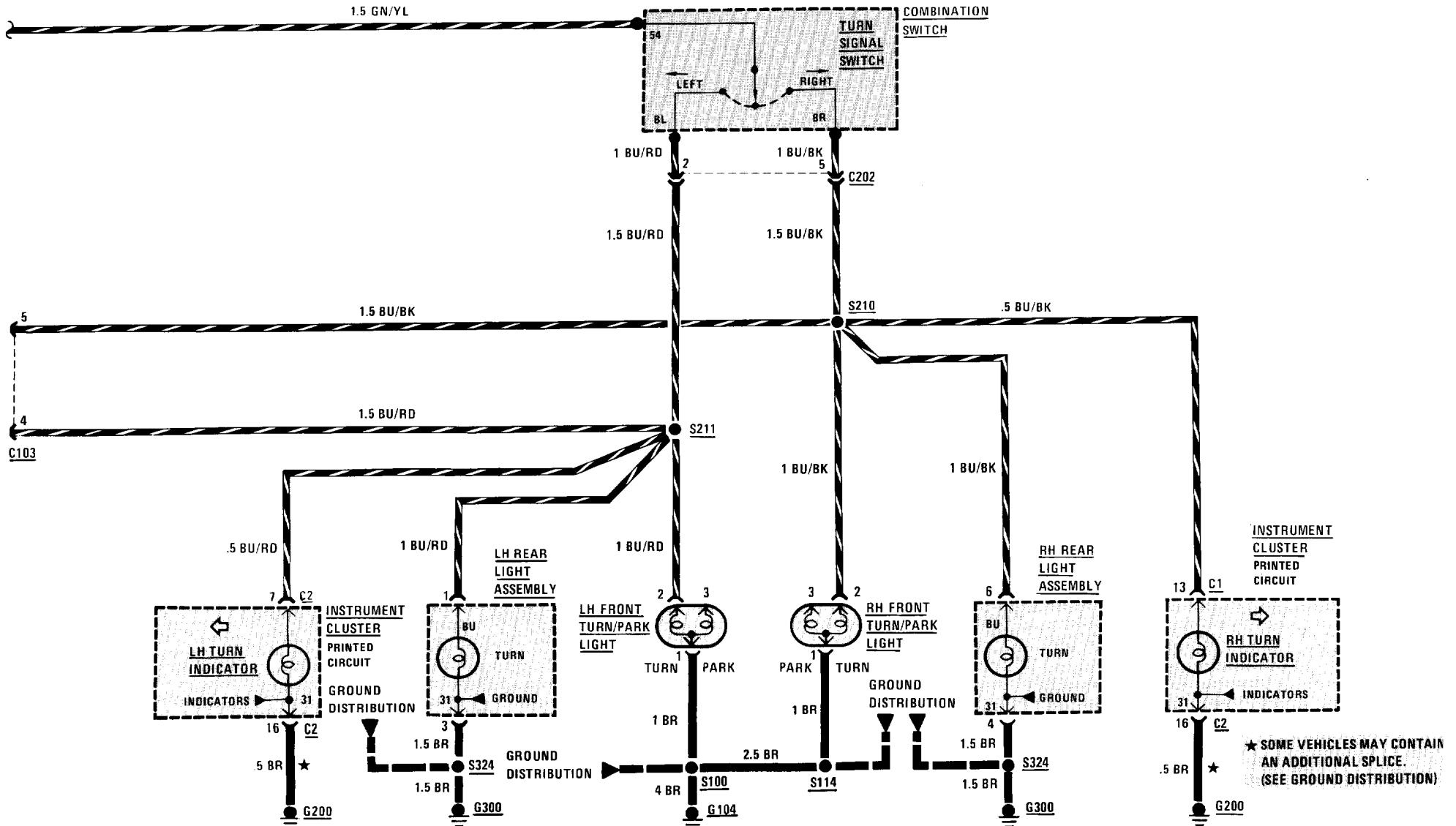

6314-0 PARK/TAIL/FRONT MARKER LIGHTS

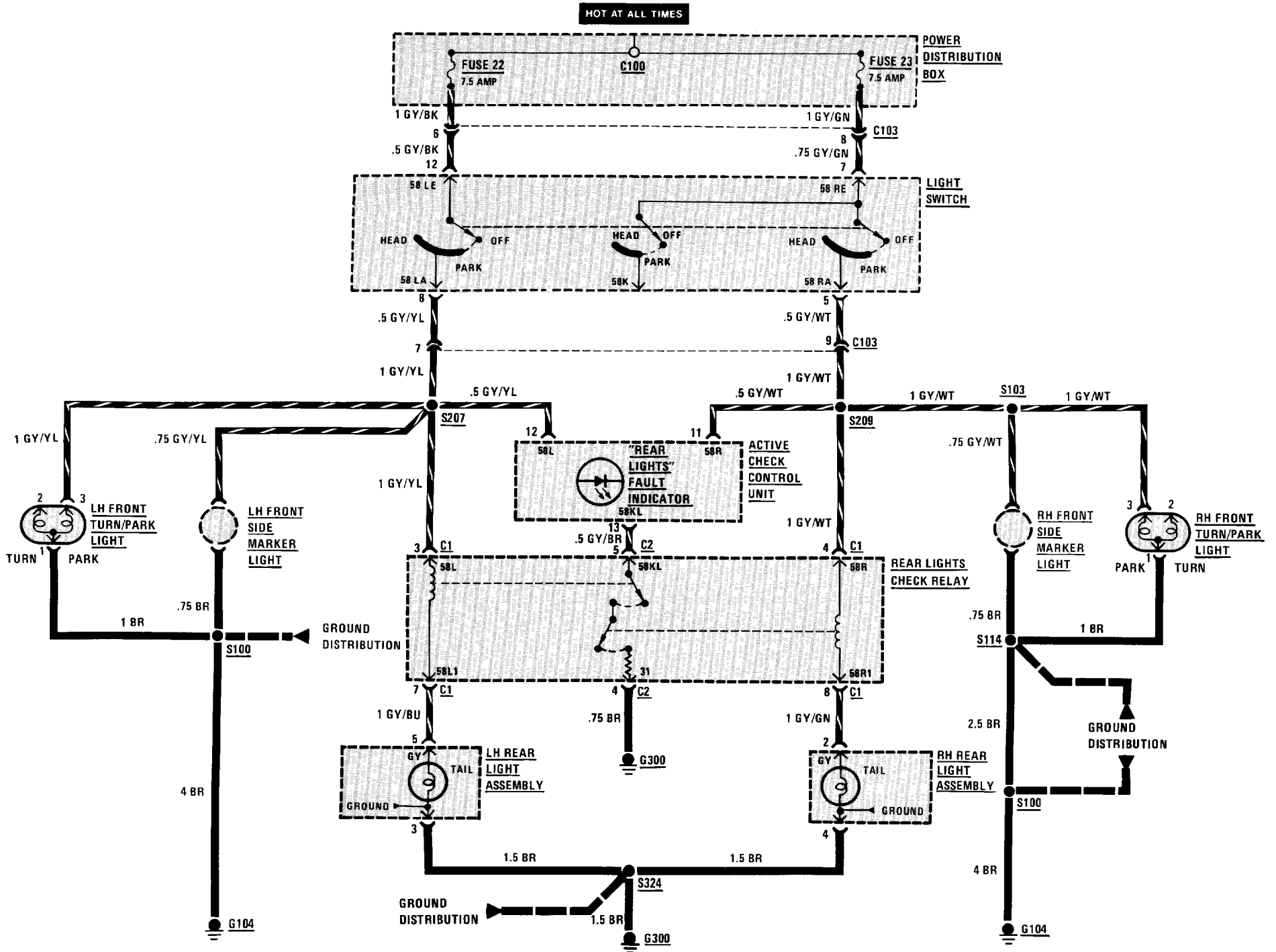

6320-0 REAR MARKER/LICENSE/TRUNK LIGHTS

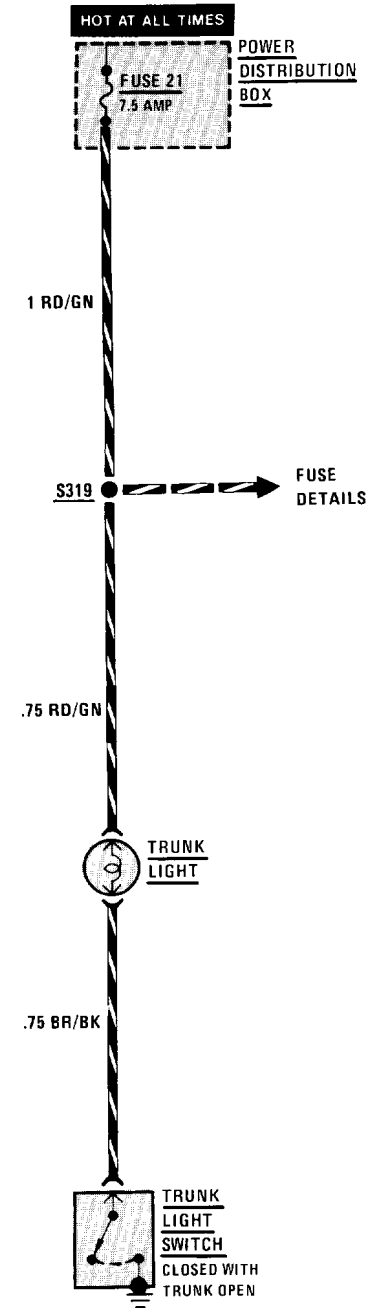
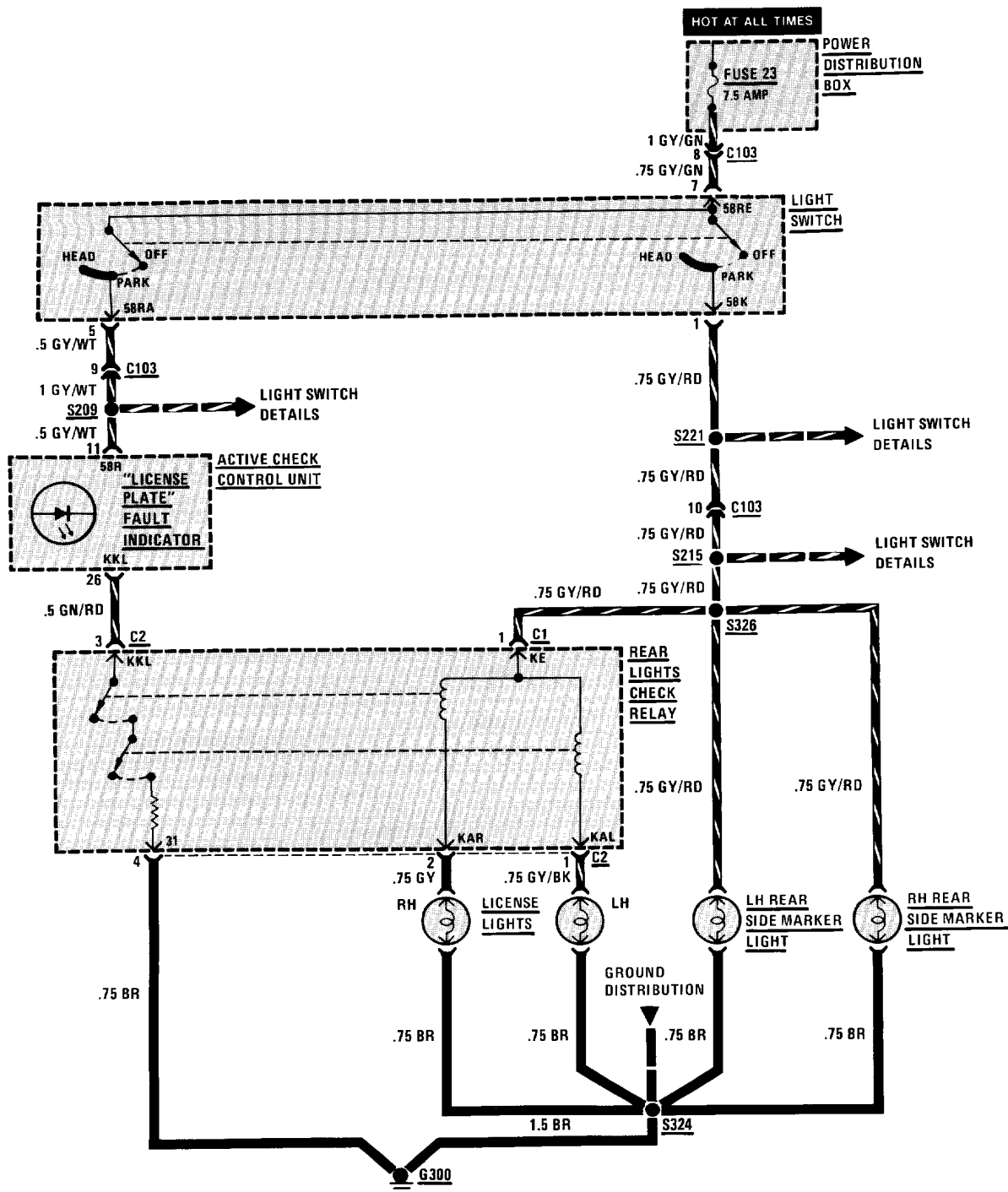

6322-0 BACK UP LIGHTS

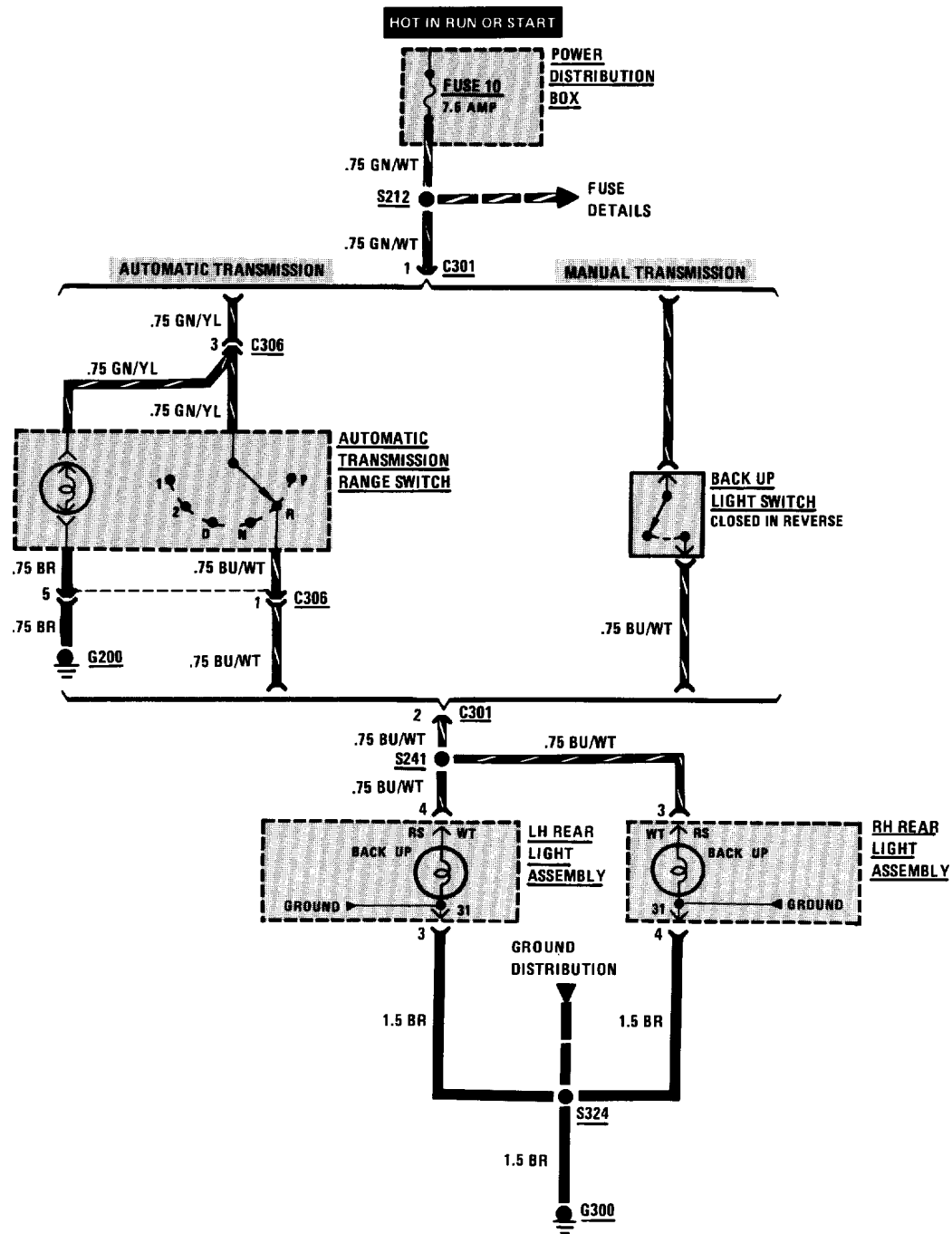

6325-0 STOP LIGHTS

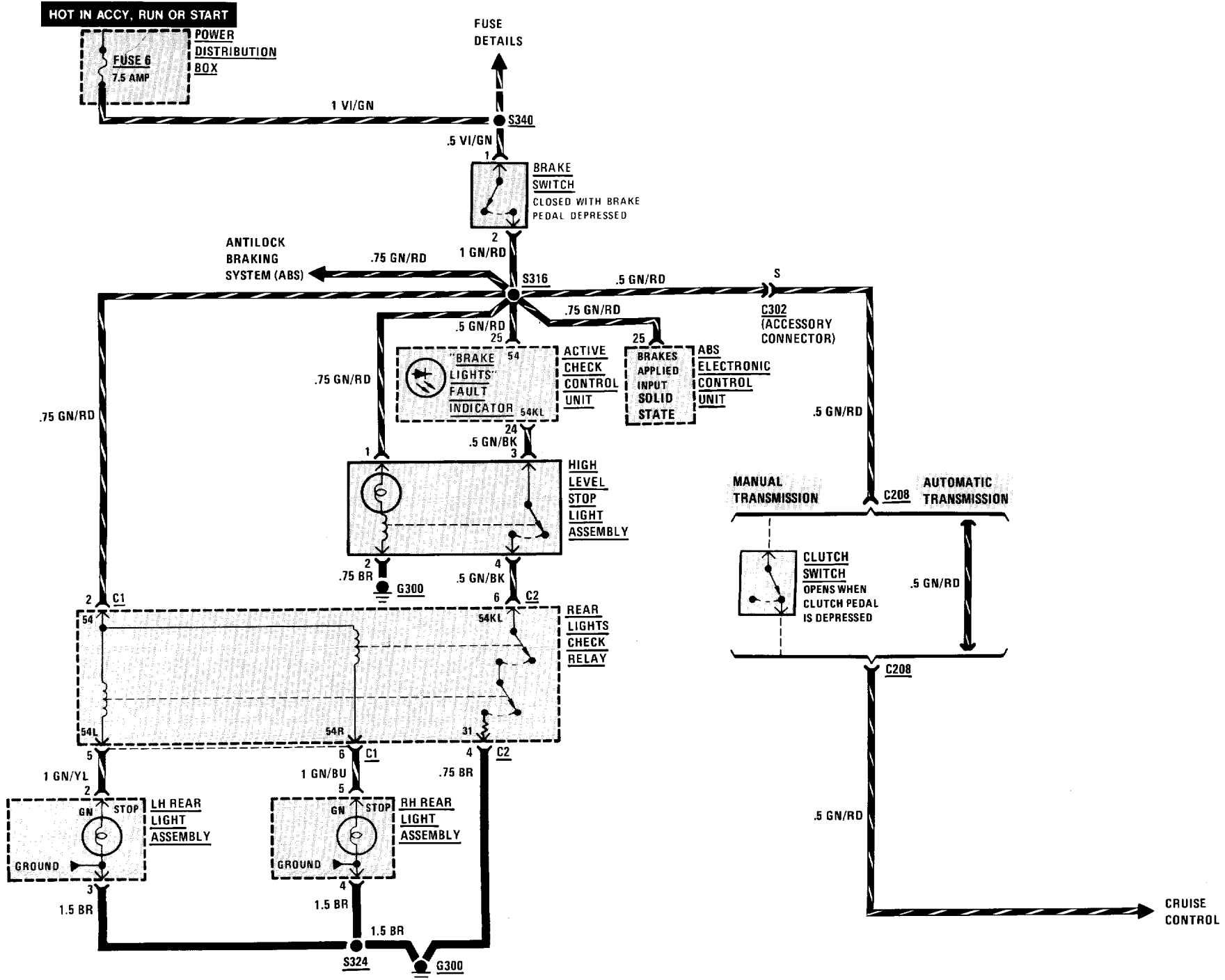

6330-0 INTERIOR LIGHTS

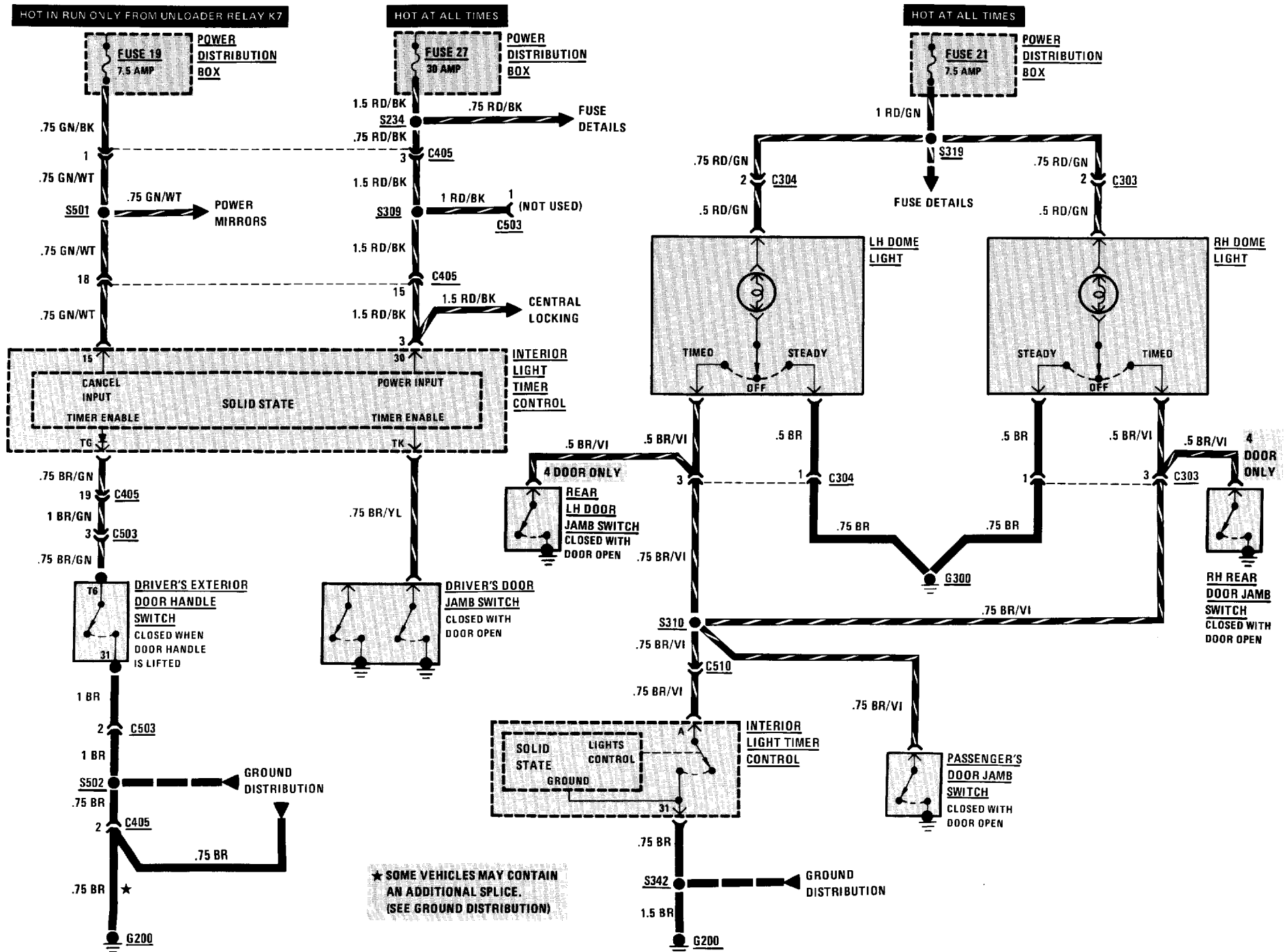

SYSTEM CHECK

This procedure provides an overall check of the Heating and Air Conditioning System. Each step can be performed without disassembly or the use of tools.

Complete this procedure with the temperature outside the car above 60 degrees F (16 degrees C) and the engine warm and running at idle.

SYSTEM CHECK TABLE

SET: Temperature Control fully counterclockwise Upper and Lower Slide Levers to extreme left Center Slide Lever to extreme right Blower Speed Control at 0 (OFF)	
ACTION	NORMAL RESULT
Press Fresh/Recirculating Air Switch (ON). Release A/C button (OFF).	Fresh/Recirculating pushbutton lights. Blower runs slowly.
Rotate Blower Speed Control through steps 1 to 4	Blower speed increases at each step to maximum speed at Step 4
Press Fresh/Recirculating Air Switch to release it (OFF)	Fresh/Recirculating button is no longer lit. Outside air is drawn into car. (The sound of Flap Door Motors may be heard repositioning flaps.)
Rotate Temperature Control at least 1/4 turn clockwise	Air flow becomes warm
Depress A/C button (ON)	A/C button lights. A/C Compressor runs. Auxiliary Cooling Fans runs.
Press A/C button to release it (OFF)	A/C button is no longer lit. A/C Compressor turns off. Auxiliary Cooling Fan turns off.
Set Blower Speed Control to 0 (OFF)	Blower turns off

- If all of the steps can be completed as described, the Heating and Air Conditioning System is operating normally.

6411-0 A/C TEMPERATURE CONTROL

HEATING AND AIR CONDITIONING (HOT WATER CONTROL)

HOT IN RUN ONLY FROM UNLOADER RELAY K7

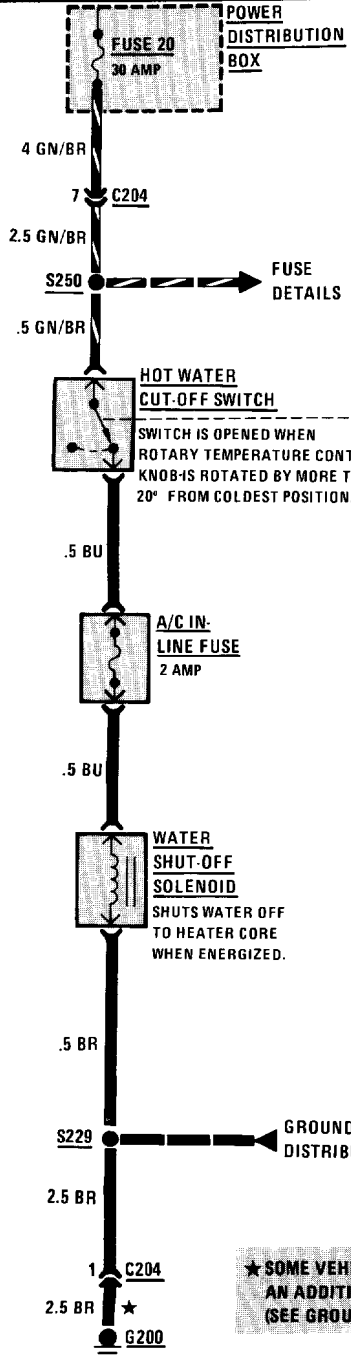

HOT WATER CUT-OFF SWITCH
 SWITCH IS OPENED WHEN ROTARY TEMPERATURE CONTROL KNOBS ARE ROTATED BY MORE THAN 20° FROM COLDEST POSITION.

HOT WATER ON
 20°
 HOT WATER OFF

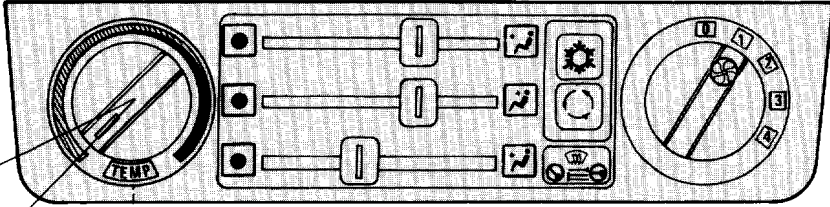

A/C CONTROL PANEL

★ SOME VEHICLES MAY CONTAIN AN ADDITIONAL SPLICE. (SEE GROUND DISTRIBUTION)

CIRCUIT OPERATION

The Water Shut-Off Solenoid controls the flow of engine coolant through the heater core. When the Solenoid is energized, coolant flow is shut off to allow maximum cooling from the Air Conditioning System. The Water Shut-Off Solenoid is controlled by the Hot Water Cut-Off Switch, which is part of the A/C Control Panel TEMP Control.

Battery voltage is applied through Fuse 20 to the Hot Water Cut-Off Switch with the Ignition Switch in RUN. The Hot Water Cut-Off Switch is closed when the TEMP Control is rotated fully counterclockwise (coldest position), and opens when the control is rotated more than 20 degrees in a clockwise direction. When the switch is closed, battery voltage is applied through the A/C In-Line Fuse to the Water Shut-Off Solenoid. The solenoid is energized and shuts off the coolant flow through the heater core.

Whenever the Water Shut-Off Solenoid is de-energized, the collapsing magnetic field induces high voltage in the coil. The A/C In-Line Diode in the 325 provides a path for the voltage so that it does not damage the contacts of the Hot Water Cut-Off Switch.

The Water Shut-Off Solenoid and A/C In-Line Diode are protected by the A/C In-Line Fuse. If any failures occur in the Solenoid or Diode, the Fuse will isolate them to prevent the failure from affecting other parts of the Heating and Air Conditioning Circuits.

TROUBLESHOOTING HINTS

- Try the following checks before doing the System Diagnosis.
- 1. Check that Water Shut-Off Solenoid connector is firmly seated.
- 2. Check A/C In-Line Fuse. If fuse is blown, check for a shorted A/C In-Line Diode.
- Go to Heating and Air Conditioning (6410A-0) System Check for a guide to normal operation.
- Go to System Diagnosis for diagnostic tests.

SYSTEM DIAGNOSIS

- Do the following test if the Water Shut-Off Solenoid does not operate normally.

WATER SHUT-OFF SOLENOID TEST (TABLE 1)

Measure: VOLTAGE At: WATER SHUT-OFF SOLENOID CONNECTOR (Disconnected) Conditions: • Ignition Switch: RUN • A/C Control Panel TEMP Control: FULLY COUNTERCLOCKWISE		
Measure Between	Correct Voltage	For Diagnosis
BU & Ground	Battery	See 1
BU & BR/RD or BR	Battery	See 2
• Rotate A/C Control Panel TEMP Control to Mid Position		
BU & Ground	0 Volts	See 3

(Continued in next column)

(Continued from previous column)

- If all voltages are correct, replace the Water Shut-Off Solenoid.
- 1. Check the BU wire and A/C In-Line Fuse for an open. If fuse is open, check that A/C In-Line Diode is not shorted. If it is, replace it. If wire, Fuse and Diode are good, go to Table 2.
- 2. Check the BR/RD or BR wire for an open to ground. Check that connector C204 is properly mated.
- 3. Check BU wire for a wire to wire short to voltage. If wire is good, replace the A/C Control Panel TEMP Control.

WATER SHUT-OFF SOLENOID TEST (TABLE 2)

Measure: VOLTAGE At: HOT WATER CUT-OFF SWITCH CONNECTOR (Disconnected) Conditions: • Ignition Switch: RUN • Water Shut-Off Solenoid: CONNECTED		
Measure Between	Correct Voltage	For Diagnosis
GN/BR & Ground	Battery	See 1
GN/BR & BU	Battery	See 2
• If both voltages are correct, replace the A/C Control Panel TEMP Control.		
1. Check the GN/BR wire for an open back to Fuse 20.		
2. Check the BU wire for an open.		

HEATING AND AIR CONDITIONING (BLOWER CONTROLS)

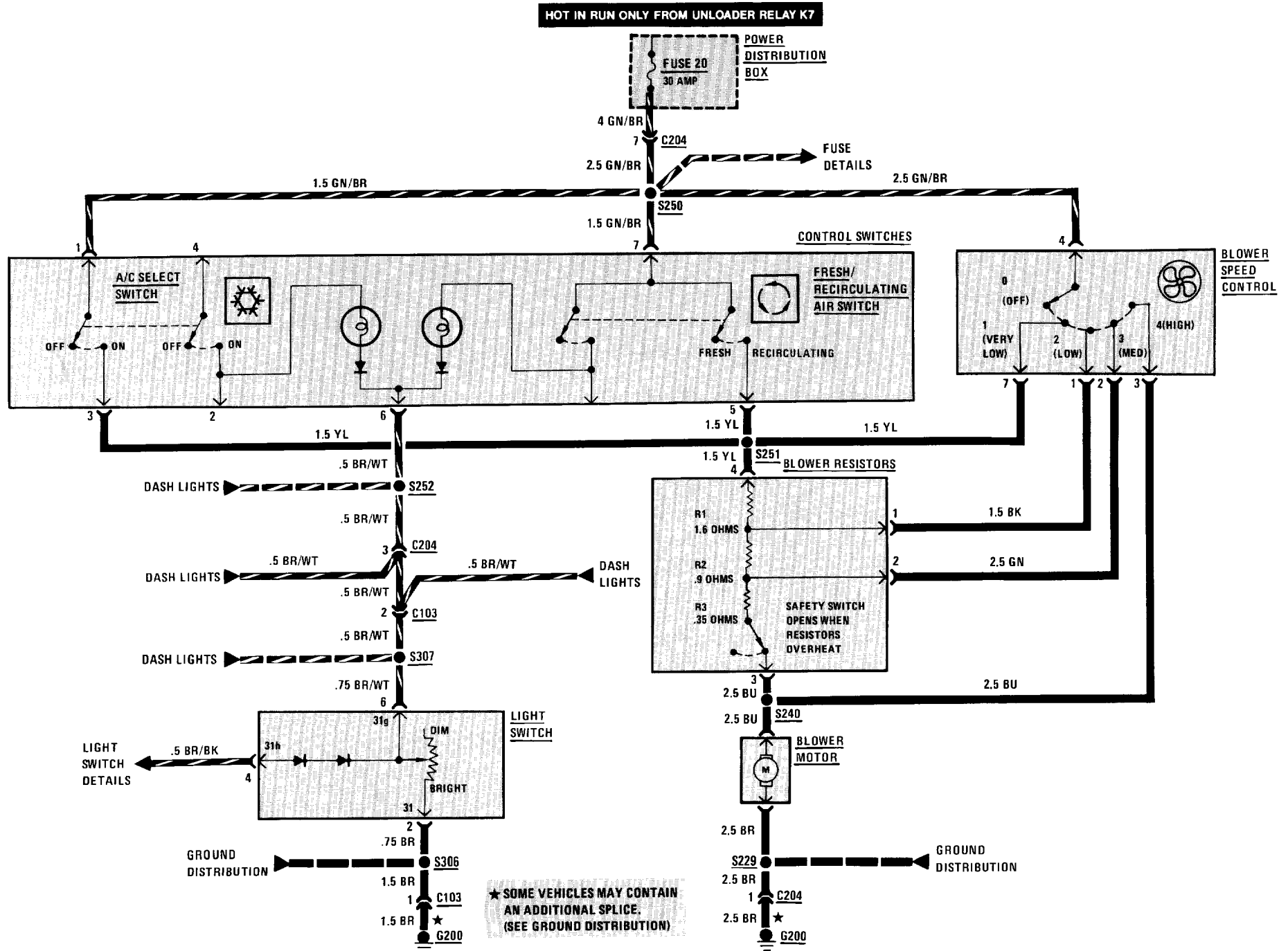

CIRCUIT OPERATION

With the Ignition Switch in RUN, battery voltage is applied to the Control Switches and Blower Speed Control through the GN/BR wires. If either the A/C Select Switch or the Fresh/Recirculating Air Switch are ON or the Blower Speed Control is in position 1, battery voltage is applied through the YL wire to the Blower Resistors and Blower Motor.

The Blower Motor is a variable speed motor which runs at a speed proportional to the voltage applied to it. With all of the Blower Resistors in the circuit, the voltage applied to the motor is reduced so the motor runs at a low speed.

As the Blower Speed Control is moved through positions 2 and 3, some resistors are bypassed, allowing more voltage to be applied to the Blower Motor, which then runs at a higher speed. When the Blower Speed Control is moved to position 4, battery voltage is applied directly to the Blower Motor, which then runs at maximum speed.

The Blower Resistors dissipate heat because of the current flowing through them. They are cooled by the air flow from the blower. If there is insufficient air flow to cool the resistors, the safety switch will open, shutting the Blower Motor off until the resistors have cooled.

TROUBLESHOOTING HINTS

- Try the following checks before doing the System Diagnosis.
 1. Check Fuse 20 by visual inspection.
 2. If Blower will run in high only, check the Blower Resistors' Safety Switch for an open.

- Go to Heating and Air Conditioning (6410-0) System Check for a guide to normal operation.
- Go to System Diagnosis for diagnostic tests.

SYSTEM DIAGNOSIS

- Do the tests listed for your symptom in the Symptom Table below.
- Tests follow the Symptom Table.

SYMPTOM TABLE

SYMPTOM	DO TEST
Blower Motor does not run in any speed setting	B
Blower runs only in HIGH (does not run in any other speed setting)	B
Blower does not run in some modes	A
Blower does not run with A/C ON or in Recirculating mode	A
A/C Select Switch or Fresh/Recirculating Air Switch does not light	A

A: CONTROL SWITCH VOLTAGE TEST

Measure: VOLTAGE At: CONTROL SWITCHES CONNECTOR (Disconnected) Conditions: <ul style="list-style-type: none"> • Ignition Switch: RUN • Blower Speed Control: OFF 		
Measure Between	Correct Voltage	For Diagnosis
1 (GN/BR) & Ground	Battery	See 1
1 (GN/BR) & 3 (YL)	Battery	See 2 & 4
7 (GN/BR) & Ground	Battery	See 1
7 (GN/BR) & 5 (YL)	Battery	See 2 & 4
7 (GN/BR) & 6(BR/WT)	Battery	See 3
<ul style="list-style-type: none"> • If all voltages are correct, do Test B. <ol style="list-style-type: none"> 1. Check the GN/BR wire for an open. 2. Check the YL wire for an open. 3. Check the BR/WT wire for an open. 4. If voltage is not present between the GN/BR wire and both the YL wires (terminals 3 and 5), do Test B. 		

B: BLOWER SPEED CONTROL TEST

Measure: VOLTAGE AT: BLOWER SPEED CONTROL CONNECTOR (Disconnected) Conditions: <ul style="list-style-type: none"> • Ignition Switch: RUN • A/C Select Switch: ON (Depressed) • Fresh/Recirculating Air Switch: FRESH (Not Depressed) 		
Measure Between	Correct Voltage	For Diagnosis
4 (GN/BR) & Ground	Battery	See 1
7 (YL) & Ground	Battery	See 2
<ul style="list-style-type: none"> • A/C Select Switch: OFF (Not Depressed) 		
7 (YL) & Ground	0 Volts	See 3
4 (GN/BR) & 7 (YL)	Battery	See 4, 8, 9, & 10
4 (GN/BR) & 1 (BK)	Battery	See 5, 8, 9, & 10
4 (GN/BR) & 2 (GN)	Battery	See 6, 8, 9, & 10
4 (GN/BR) & 3 (BU)	Battery	See 7 & 10
<ul style="list-style-type: none"> • If all voltages are correct, replace the Blower Motor. <ol style="list-style-type: none"> 1. Check the GN/BR wire for an open. 2. Check the YL wire for an open between Blower Speed Control and splice S231. 3. Check the YL wire for a wire to wire short to voltage. 		

(Continued in next column)

(Continued from previous column)

<ol style="list-style-type: none"> 4. Check the YL wire for an open between splice S231 and the Blower Resistors. 5. Check the BK wire for an open. 6. Check the GN wire for an open. 7. Check the BU wire for an open. 8. If voltage is not present at the YL wire, but is present at the GN wire or BK wire, replace the Blower Resistors. 9. If voltage is not present at the YL, BK or GN wires, check for an open Blower Resistors' Safety Switch. 10. If voltage is not present at the YL, BK, GN and BU wires, do Test C.

C: BLOWER MOTOR TEST

Measure: VOLTAGE At: BLOWER MOTOR CONNECTOR (Disconnected) Conditions: <ul style="list-style-type: none"> • Ignition Switch: RUN • A/C Select Switch: ON • Blower Speed Control: HIGH 		
Measure Between	Correct Voltage	For Diagnosis
BU & Ground	Battery	See 1
BU & BR	Battery	See 2
<ul style="list-style-type: none"> • If both voltages are correct, replace the Blower Motor. <ol style="list-style-type: none"> 1. Check the BU wire for an open. If wire is good, recheck Test B. 2. Check the BR wire to ground G200 for an open. 		

6421-0 A/C AIR DELIVERY CONTROL

HEATING AND AIR CONDITIONING (FRESH/RECIRCULATING AIR CONTROLS)

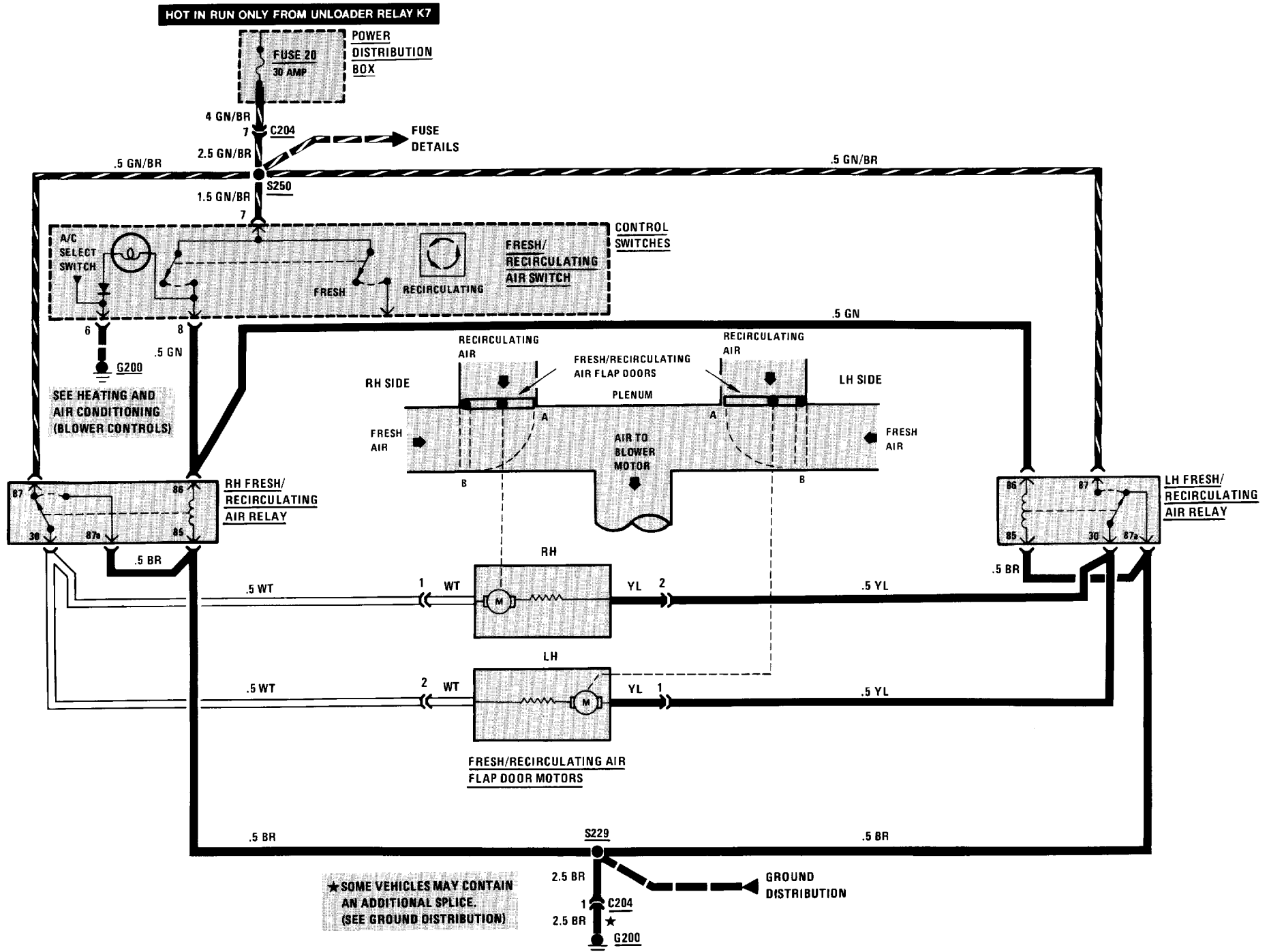

CIRCUIT OPERATION

When the Ignition Switch is in RUN, battery voltage is applied to terminal 7 of the Control Switches, the normally open contacts of the LH Fresh/Recirculating Air Relay, and the normally closed contacts of the RH Fresh/Recirculating Air Relay. If the Fresh/Recirculating Air Switch is not depressed (open), battery voltage is applied through the normally closed contacts of the RH Fresh/Recirculating Air Relay to both Fresh/Recirculating Air Flap Door Motors and then to ground through the normally closed contacts of the LH Fresh/Recirculating Air Relay. Both motors operate and move the Fresh/Recirculating Air Flap Doors to position A, allowing fresh air to enter the blower.

When the Fresh/Recirculating Air Switch is depressed (closed), battery voltage is applied through the switch to both the LH and RH Fresh/Recirculating Air Relay coils. Both relays are energized. Battery voltage is then applied through the closed contacts of the LH Fresh/Recirculating Air Relay to the Flap Door Motors, and to ground through the closed contacts of the RH Fresh/Recirculating Air Relay. Since the voltage is now applied to the Flap Door Motors in the opposite direction, the motors reverse direction and move the Fresh/Recirculating Air Flap Doors to position B, allowing only recirculating air to enter the blower. Both of the Air Flap Door Motors remain energized continuously. When the doors reach the end of their travel, the motors stall and hold the doors in position.

TROUBLESHOOTING HINTS

- Try the following checks before doing the System Diagnosis.
- 1. Check that LH and RH Fresh/Recirculating Air Relays are firmly seated.
- 2. Check that LH and RH Fresh/Recirculating Air Relay pigtail connectors are properly mated.
- Go to Heating and Air Conditioning (6410-0) System Check for a guide to normal operation.
- Go to System Diagnosis for diagnostic tests.

SYSTEM DIAGNOSIS

- Do the tests below if the Fresh/Recirculating Air Flap Doors do not operate.

A: FRESH/RECIRCULATING AIR FLAP DOOR MOTOR VOLTAGE TEST

Measure: VOLTAGE At: FRESH/RECIRCULATING AIR FLAP DOOR MOTOR PIGTAIL CONNECTORS (Disconnected) Conditions: <ul style="list-style-type: none"> • Ignition Switch: RUN • Fresh/Recirculating Air Switch: RELEASED (FRESH) 		
Measure Between	Correct Voltage	For Diagnosis
WT and Ground	Battery	See 1
WT and YL	Battery	See 2
• Fresh/Recirculating Air Switch: DEPRESSED (RECIRCULATING)		
YL and Ground	Battery	See 3

(Continued in next column)

(Continued from previous column)

YL and WT	Battery	See 3
• If all voltages are correct, replace the inoperative motor.		
1. Check the WT wire for an open. If wire is good, do Test B for RH Air Relay.		
2. Check the YL wire for an open. If wire is good, do Test B for LH Air Relay.		
3. Do Test B for both Air Relays.		

B: FRESH/RECIRCULATING AIR RELAY VOLTAGE TEST

Measure: VOLTAGE At: FRESH/RECIRCULATING AIR RELAY CONNECTOR (Disconnected) Conditions: <ul style="list-style-type: none"> • Ignition Switch: RUN • Fresh/Recirculating Air Switch: DEPRESSED (RECIRCULATING) • Fresh/Recirculating Air Flap Door Motor Connectors: CONNECTED 		
Measure Between	Correct Voltage	For Diagnosis
87 (GN/BR) and Ground	Battery	See 1
86 (GN) and Ground	Battery	See 2
86 (GN) and 85 (BR)	Battery	See 3
86 (GN) and 87a (BR)	Battery	See 3

(Continued on next page)

(Continued from previous page)

- If all voltages are correct, replace the suspect Fresh/Recirculating Air Relay.
1. Check the GN/BR wire for an open.
 2. Check the GN wire back to the Control Switches for an open. If wire is good, do Test C.
 3. Check the BR wire for an open.

C: CONTROL SWITCHES VOLTAGE TEST

Measure: VOLTAGE At: CONTROL SWITCHES CONNECTOR (Disconnected) Condition: • Ignition Switch: RUN		
Measure Between	Correct Voltage	For Diagnosis
7 (GN/BR) & Ground	Battery	See 1
7 (GN/BR) & 8 (GN)	Battery	See 2
<ul style="list-style-type: none"> • If both voltages are correct, replace the Control Switches. <ol style="list-style-type: none"> 1. Check the GN/BR wire for an open. If wire is good, check that connector C204 is properly mated. 2. Check the GN wire for an open between the Control Switches and the LH and RH Fresh/Recirculating Air Relays. 		

6452-0 A/C COMPRESSOR CONTROLS

HEATING AND AIR CONDITIONING (COMPRESSOR CONTROLS)

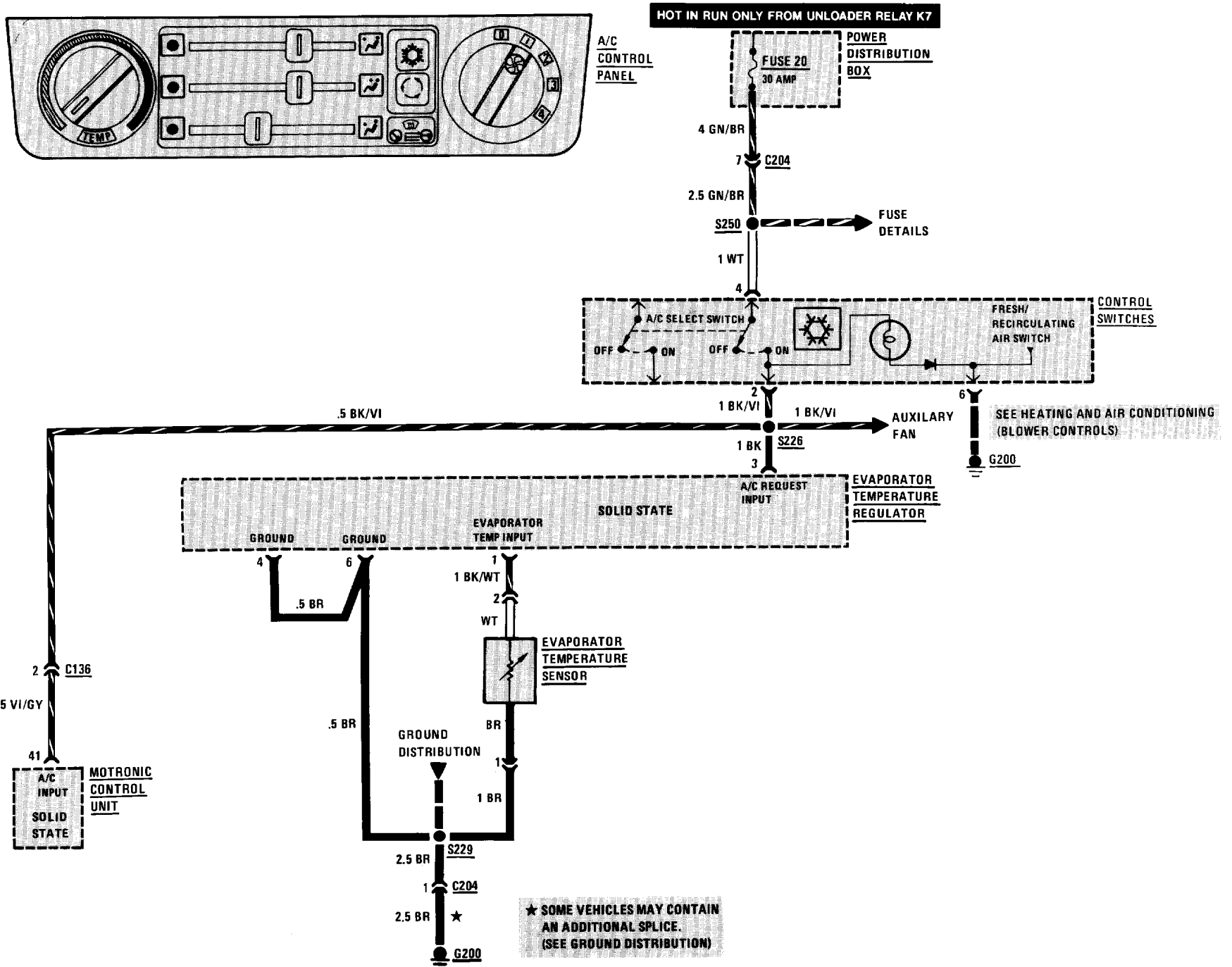

HEATING AND AIR CONDITIONING (COMPRESSOR CONTROLS)

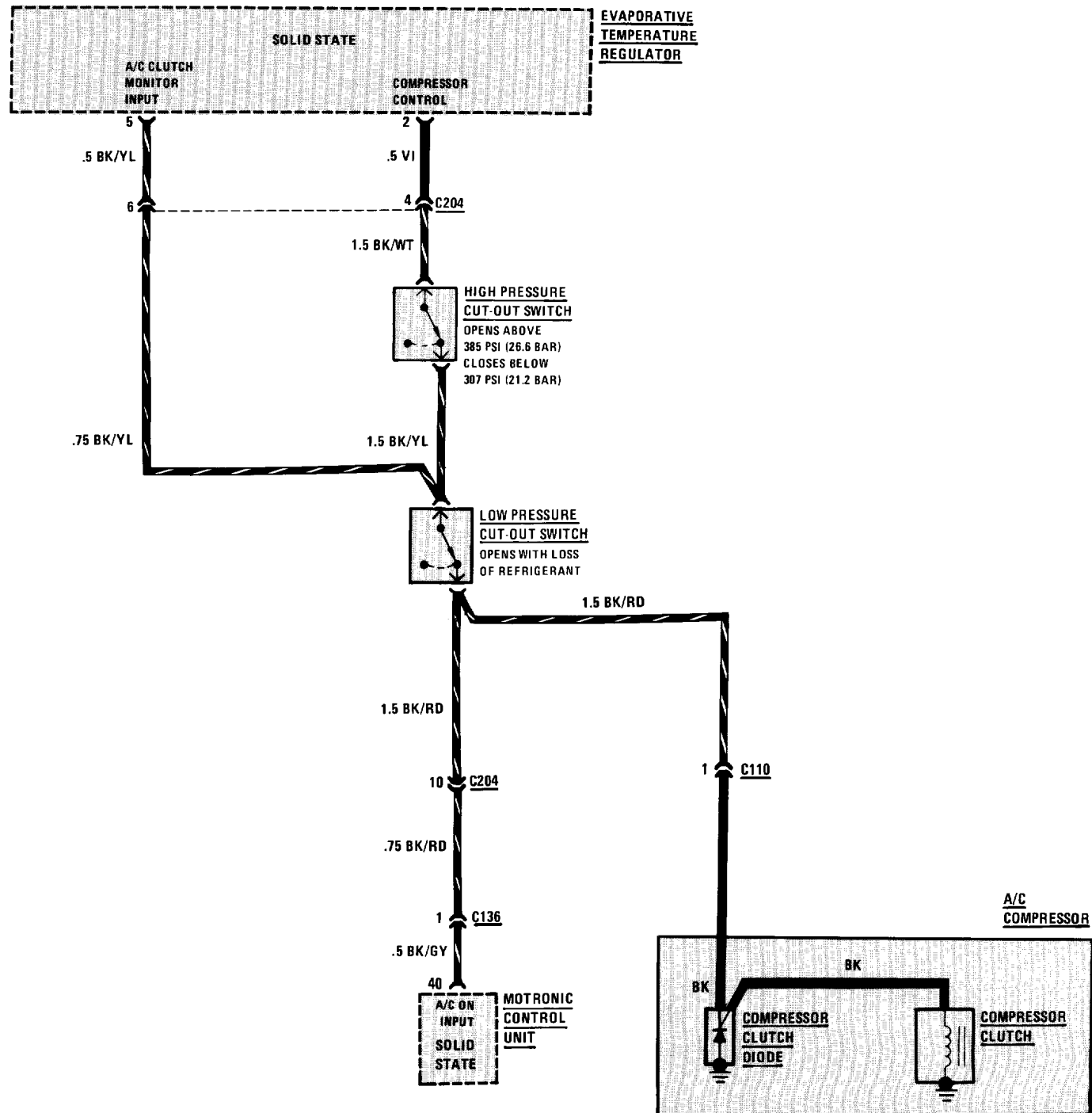

CIRCUIT OPERATION

When the Ignition Switch is in RUN, battery voltage is applied through Fuse 20 to the A/C Select Switch. When the A/C Select Switch is pressed, voltage is applied to terminal 3 of the Evaporator Temperature Regulator. The Evaporator Temperature Regulator applies voltage from terminal 2 to the Compressor Clutch through the High Pressure Cut-Out Switch and Low Pressure Cut-Out Switch.

The High Pressure Cut-Out Switch will disengage the Compressor Clutch when refrigerant pressure rises above 385 PSI (26.6 Bar). The Evaporator Temperature Regulator will detect the High Pressure Cut-Out Switch opening at terminal 5 and will turn off the output voltage at the Compressor Control terminal. The Evaporator Temperature Regulator will not allow the Compressor Clutch to be turned on again until circuit continuity has been restored between terminals 5 and 2. The Evaporator Temperature Regulator tests for continuity by momentarily applying voltage at the Compressor Control every 8 to 10 seconds. Voltage at the A/C Clutch Monitor Input indicates continuity. The Evaporator Temperature Regulator will continue to apply voltage at the Compressor Control output, which will energize the Compressor Clutch.

Clutch Diode

Whenever the Compressor Clutch is de-energized, the collapsing magnetic field induces a voltage in the winding. The Clutch Diode provides a path for the resulting current.

A/C On Input

When the Compressor Clutch is turned on, voltage is applied to terminal 29 of the Motronic Control Unit. The Motronic Control Unit uses this signal increase idle speed to compensate for the increased engine load from the Compressor Clutch engaging.

TROUBLESHOOTING HINTS

- Try the following checks before doing the System Diagnosis.
 1. Check Fuse 20 by visual inspection.
 2. Check that Compressor Clutch connector is firmly seated.
- Go to Heating and Air Conditioning (6410A-0) System Check for a guide to normal operation.
- Go to System Diagnosis for diagnostic tests.

SYSTEM DIAGNOSIS

- Do the tests listed for your symptom in the Symptom Table below.
- Tests follow the Symptom Table.

SYMPTOM TABLE

Compressor Clutch does not engage	A
Engine idle speed is not high enough when Compressor Clutch engages	D

A: A/C ISOLATION TEST (TABLE 1)

Measure: VOLTAGE At: EVAPORATOR TEMPERATURE REGULATOR (Disconnected) Conditions: • Ignition Switch: RUN (Engine need not be running) • A/C Selector Switch: ON (Depressed)		
Measure Between	Correct Voltage	For Diagnosis
3 & Ground	Battery	See 1
• If voltage is correct, go to Table 2. 1. Go to Test E.		

A: A/C ISOLATION TEST (TABLE 2)

Connect: FUSED JUMPER At: EVAPORATOR TEMPERATURE REGULATOR (Disconnected) Conditions: • Ignition Switch: RUN • A/C Selector Switch: ON (Depressed)		
Connect Across	Correct Result	For Diagnosis
2 & 3	Compressor Clutch Engages	See 1
• If result is correct go to Test C. 1. Go to Test B.		

B: PRESSURE SWITCH TEST

Measure: RESISTANCE At: EVAPORATOR TEMPERATURE REGULATOR CONNECTOR (Disconnected) Conditions: • Ignition Switch: OFF • Negative Battery Terminal: DISCONNECTED		
Measure Between	Correct Resistance	For Diagnosis
2 & Ground	Approximately 3 to 4 ohms	See 1
• If measurement is correct replace the Evaporator Temperature Regulator. 1. Check for an open Low Pressure Cut-Out Switch, High Pressure Cut-Out Switch, A/C Temperature Switch, or associated wiring (see schematic). If High Pressure Cut-Out Switch is open, replace it. If Low Pressure Cut-Out Switch is open, check refrigerant pressure to be sure it is normal before replacing the switch. If the switch and related wiring are OK, replace the Compressor Clutch.		

C: EVAPORATOR TEMPERATURE REGULATOR VOLTAGE AND RESISTANCE TEST

Measure: RESISTANCE At: EVAPORATOR TEMPERATURE REGULATOR CONNECTOR (Disconnected) Conditions: • Ignition Switch: OFF • Negative Battery Terminal: DISCONNECTED		
Measure Between	Correct Resistance	For Diagnosis
1 & Ground	Approximately 3.5K to 4.5K ohms at 70 °F (21 °C)	See 1
4 & Ground	Less than 0.5 ohms	See 2
6 & Ground	Less than 0.5 ohms	See 2
5 & 2	Less than 0.5 ohms	See 3
• If all resistances are correct but Compressor Clutch does not operate normally, replace the Evaporator Temperature Regulator. 1. Check the BK/WT wire for an open or a short to ground (see schematic). Check the BR wire for an open (see schematic). If wires are good, replace the Evaporator Temperature Sensor. 2. Check the BR wire for an open (see schematic). 3. Check BK/YL for an open between terminal 5 and the Low Pressure Cut-Out Switch.		

D: IDLE SPEED CONTROL VOLTAGE TEST

<p>Measure: VOLTAGE At: MOTRONIC CONTROL UNIT CONNECTOR (Connected – Universal Adapter) Conditions:</p> <ul style="list-style-type: none"> • Ignition Switch: RUN • A/C Control Panel: A/C ON • Temperature Outside Car: Above 60 degrees F (16 degrees C) 		
Measure Between	Correct Voltage	For Diagnosis
40 (BK/GY) & Ground	Battery	See 1
41 (VI/GY) & Ground	Battery	See 2
<ul style="list-style-type: none"> • If the voltage is correct, repair/replace the Motronic Control Unit. <ol style="list-style-type: none"> 1. Check for an open in the BL/WT and BK/RD wires. 2. Check for an open in the VI/GY and BK/VI wires. 		

E: A/C SELECT SWITCH VOLTAGE TEST

<p>Measure: VOLTAGE At: CONTROL SWITCHES CONNECTOR (Connected) Conditions:</p> <ul style="list-style-type: none"> • Ignition Switch: RUN • A/C Control Panel: A/C ON • Temperature Outside Car: Above 60 degrees F (16 degrees C) 		
Measure Between	Correct Voltage	For Diagnosis
4 (WT) & Ground	Battery	See 1
2 (BK/VI) & Ground	Battery	See 2
<ul style="list-style-type: none"> • If both voltages are correct, check connections at Evaporator Temperature Regulator. <ol style="list-style-type: none"> 1. Check for an open in the WT and GN/BR wires. 2. Replace the A/C Select Switch. 		

6454-0 AUXILIARY FAN

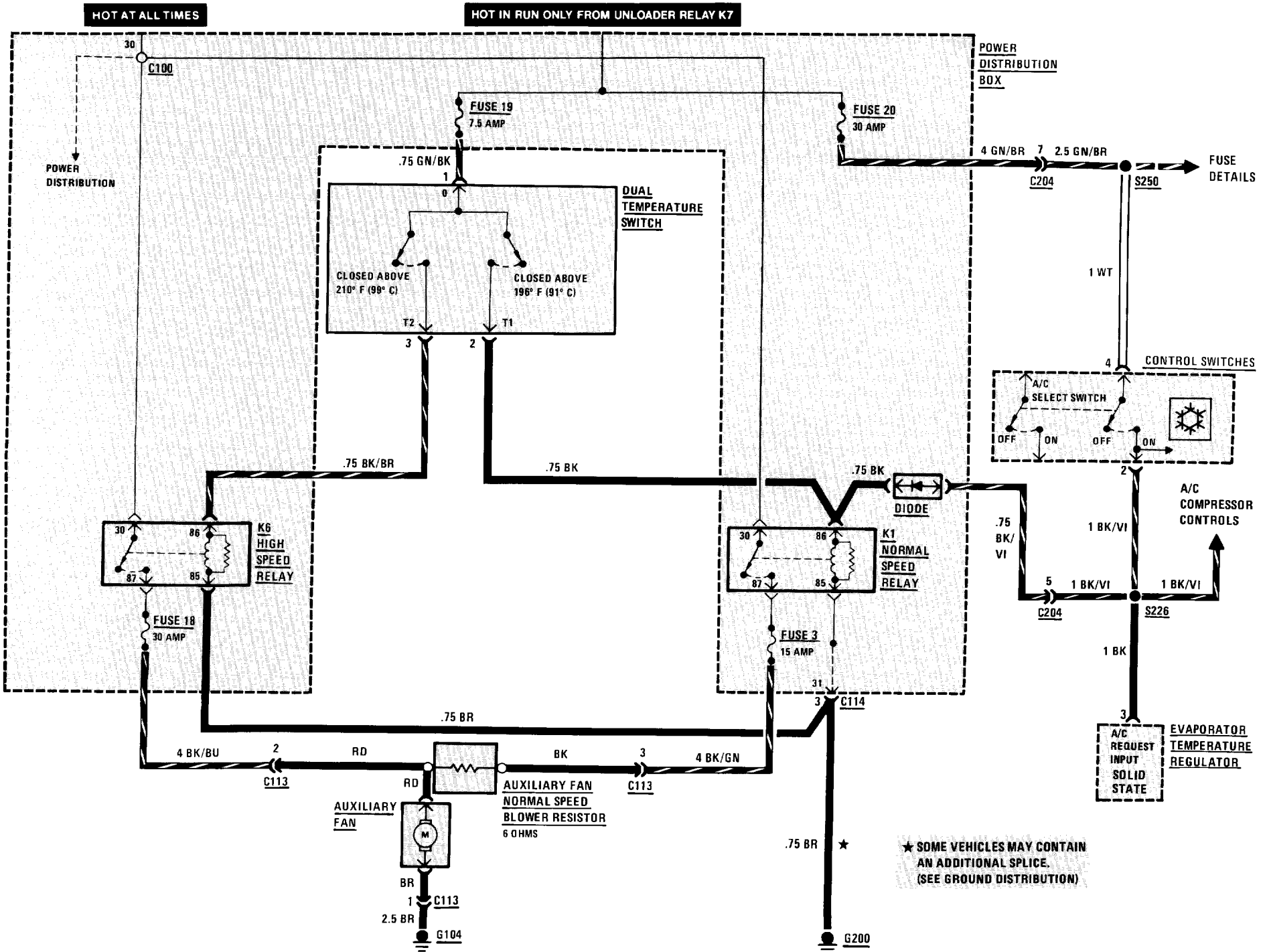

6500-0 RADIO/POWER ANTENNA

RADIO ONLY (LATE PRODUCTION)

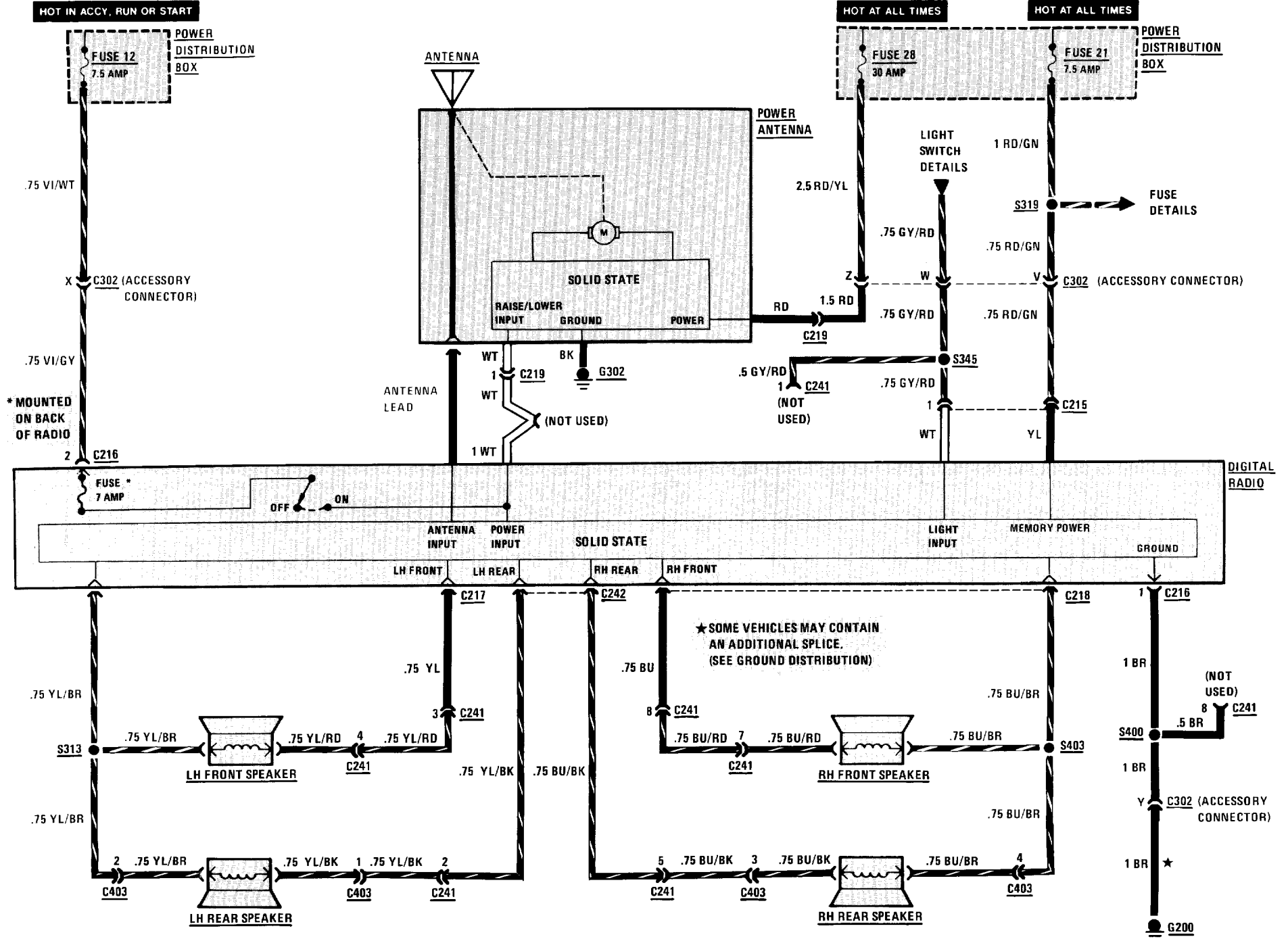

RADIO ONLY (LATE PRODUCTION)

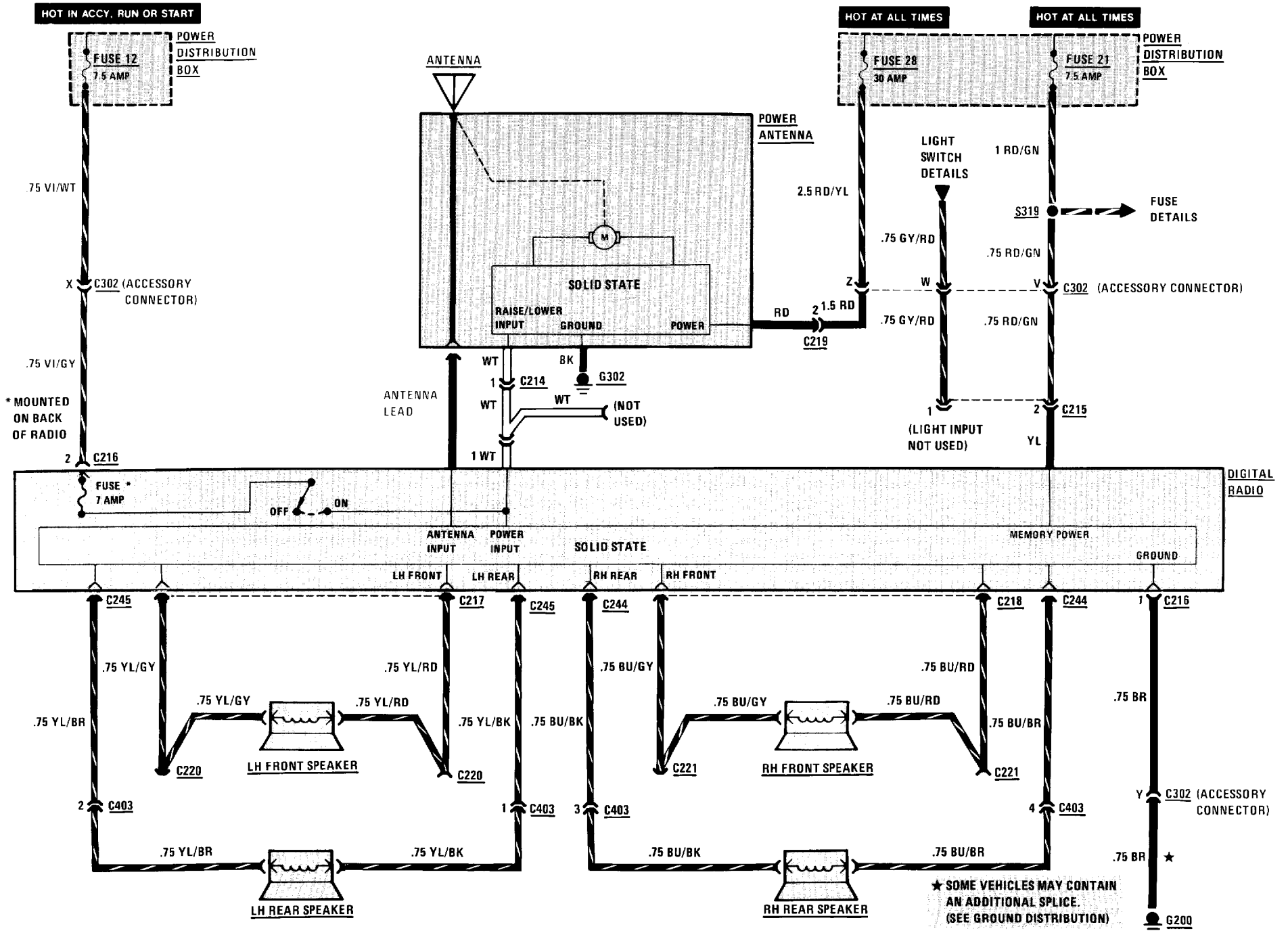

CIRCUIT OPERATION

With the Ignition Switch in ACCY, RUN or START, Fuse 12 provides voltage to turn on the three components in the system. When the Radio Switch is on, voltage is applied to the Radio and the Power Antenna Raise/Lower Input. This voltage is used to control the individual unit's main power supply.

When the Raise/Lower Input of the Power Antenna receives voltage, power is supplied from Fuse 28 to run the motor and raise the Antenna. when voltage is no longer present at the Raise/Lower Input, the Antenna is lowered.

Fuse 21 constantly supplies voltage to the Memory Power Input of the Radio. This allows the Radio to maintain the present settings while it is turned off.

The actual Radio signal originates at the Antenna. It is supplied to the Radio, processed, and output from the Left Channel and Right Channel Outputs. The signal is then input to the Left Front, Left Rear, Right Front and Right Rear Inputs to the Amplifier.

TROUBLESHOOTING HINTS

- Try the following checks before doing the System Check.
 1. Check power input to the Radio by observing if Instrument Cluster Indicators light.
 2. Check power input to Antenna by observing the Cigar Lighter.
 3. Check memory power to Radio by checking operation of the Glove Box Light.
 4. Check that the Antenna is properly connected.
 5. Before troubleshooting a suspect Speaker, check all connections to that Speaker.
 6. If display shows "CODE" and Radio will not operate, the individual Anti-Theft Code must be entered. Refer to "Anti-Theft" instruction booklet.
 7. Check Radio Fuse located on back of Radio.
 8. If a speaker is inoperative, switch with a good speaker. If still inoperative, check related wiring. Remove Radio for service if wiring is OK.

SYSTEM CHECK

- Use the System Check Table as a guide to normal operation.
- Refer to System Diagnosis for a list of symptoms and diagnostic steps.

SYSTEM CHECK TABLE

ACTION	NORMAL RESULT
With Ignition Switch in RUN, turn Radio ON.	Antenna extends. Digital display lights. Sound is emitted from all Speakers.
Operate Fader Control.	Sound volume varies from front to rear.

- Refer to System Diagnosis when a result is not normal.

SYSTEM DIAGNOSIS

- Do the tests listed for your symptom in the Symptom Table below.
- Tests follow the Symptom Table.

SYMPTOM TABLE

SYMPTOM	FOR DIAGNOSIS
Radio does not work (no display, no sound).	Do Test A
LH Speakers or RH Speakers do not operate.	Do Test B

(Continued on next page)

(Continued from previous page)

Antenna does not extend or retract.	Check ground wire for an open. Make sure ground G302 is clean and tight. Check wire to Power Antenna for opens. If OK, replace Power Antenna.
An individual Speaker does not operate.	Do Test C
Excessive noise comes from all Speakers.	Do Test D

A: RADIO POWER TEST

Measure: VOLTAGE		
At: RADIO CONNECTOR C216 (Disconnected) or CONNECTOR C215 (Disconnected)		
Condition:		
• Ignition Switch: RUN		
Measure Between	Correct Voltage	For Diagnosis
C216 & Ground	Battery	See 1
C216/2 & C216/1	Battery	See 2
C215/2 & Ground	Battery	See 3
<ul style="list-style-type: none"> If all voltages are correct, check wire from connector C215 to Radio for an open. If wire is OK, remove Radio for service. <ol style="list-style-type: none"> Check power input wire for an open. Check ground wire for an open to ground. Make sure ground G200 is clean and tight. Check memory power supply wire for an open. 		

B: SUSPECT SPEAKER TEST

Connect: OHMMETER		
At: SUSPECT SPEAKER (Disconnected)		
Condition:		
• Ohmmeter set on Rx 1 scale or Diode Check Scale		
Action	Correct Result	For Diagnosis
Connect Ohmmeter across Speaker Terminals	Speaker "pops"	See 1
<ul style="list-style-type: none"> If the result is correct, check wires to the Radio for opens or shorts. If OK, removed Radio for service. <ol style="list-style-type: none"> Replace the suspect Speaker. 		

C: NOISE DIAGNOSIS

- With Radio on and noise present, unplug the Antenna at the back of the Radio.
- If noise is no longer present, it was being picked up by the Antenna. Perform Antenna Noise Test.
 - If noise persists, it is coming in the Radio wiring. Refer to the following Noise Symptom Table.

ANTENNA NOISE TEST

Measure: RESISTANCE		
At: ANTENNA		
Measure Between	Correct Resistance	For Diagnosis
Antenna Plug Base & Ground	Less than 3 Ohms	See 1
Antenna Plug Tip & Antenna Plug Base	Greater than 1 Megohm (open circuit)	See 2
<ul style="list-style-type: none"> If both resistances are correct, check the hood ground strap. If OK, substitute different Antenna at Radio. If good, replace Antenna. If noise is still present, refer to Noise Symptom Table. <ol style="list-style-type: none"> Check ground contact at Antenna base. If necessary, install a braided ground strap from the Antenna Base to Chassis ground. Check for an open in the Antenna Cable. Check for a short to ground at the Antenna or Antenna cable. 		

6500A-2 RADIO/ANTENNA

NOISE SYMPTOM TABLE

SYMPTOM	POSSIBLE CAUSE	REPAIR ACTION
Harsh popping or crackling noise present when ignition on-changes with engine rpm.	Ignition Noise	<ul style="list-style-type: none">• Check for proper distributor cap shielding.• Check shielding ground strap. If not present, install.• Check for defective spark plug or spark plug wire.• Reroute spark plug wires laying against anything that could be transmitting noise to the Radio (wiring or sensor leads traveling into the passenger compartment).• Check engine/firewall ground strap and engine hood/body ground strap.• Check if engine hood is closing properly.• Connect dedicated ground strap to Radio.• Replace distributor cap and rotor.
High whine or howling that changes with engine rpm.	Alternator noise	<ul style="list-style-type: none">• Connect dedicated ground strap to Radio.• Run a direct wire from Battery to Alternator.
AM only is weak and noisy.	AM alignment	<ul style="list-style-type: none">• Remove Radio for service.
FM only is weak and noisy.	FM alignment	<ul style="list-style-type: none">• Remove Radio for service.

6571-0 CRUISE CONTROL

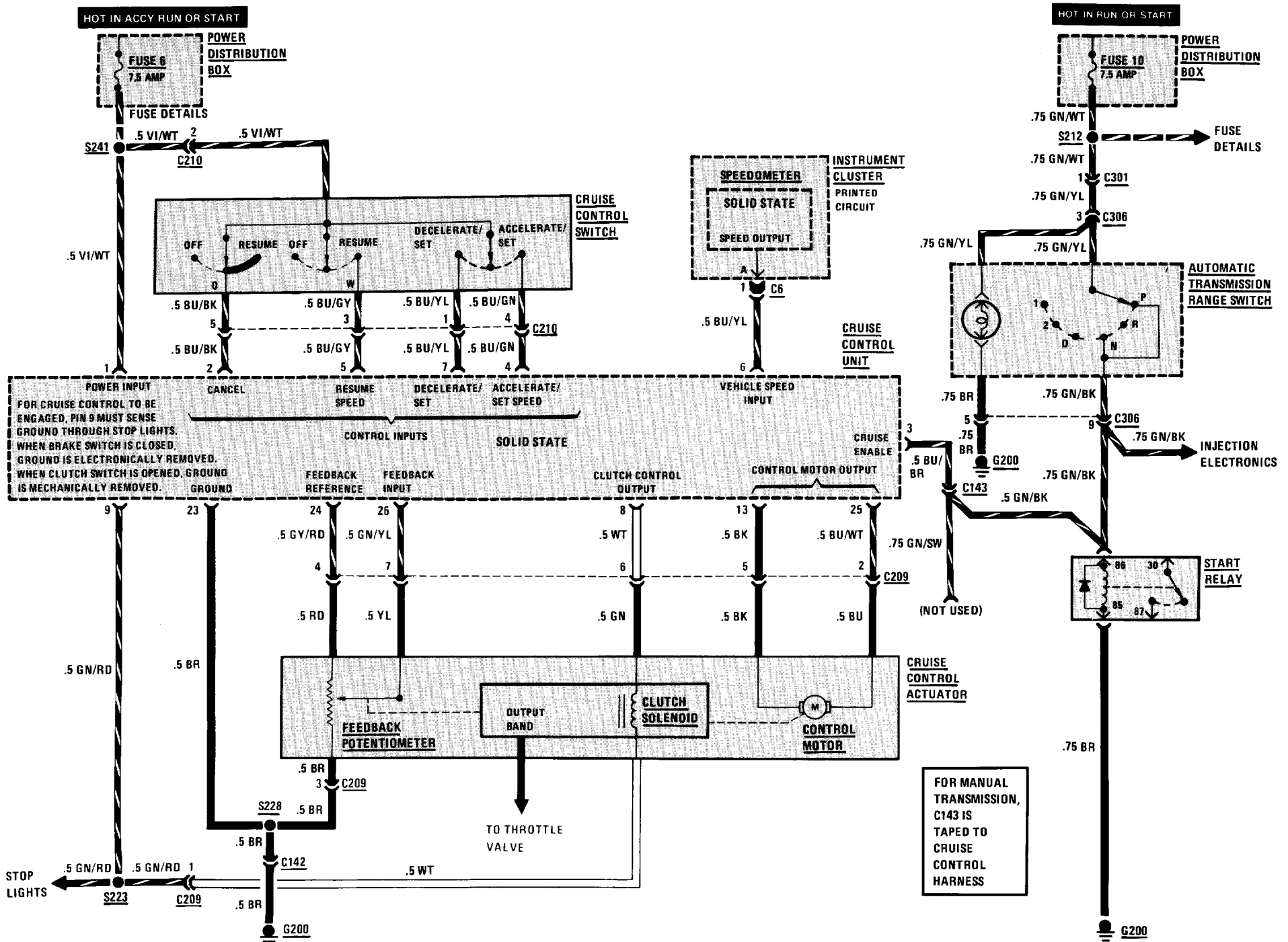

6581-0 MULTIFUNCTION CLOCK

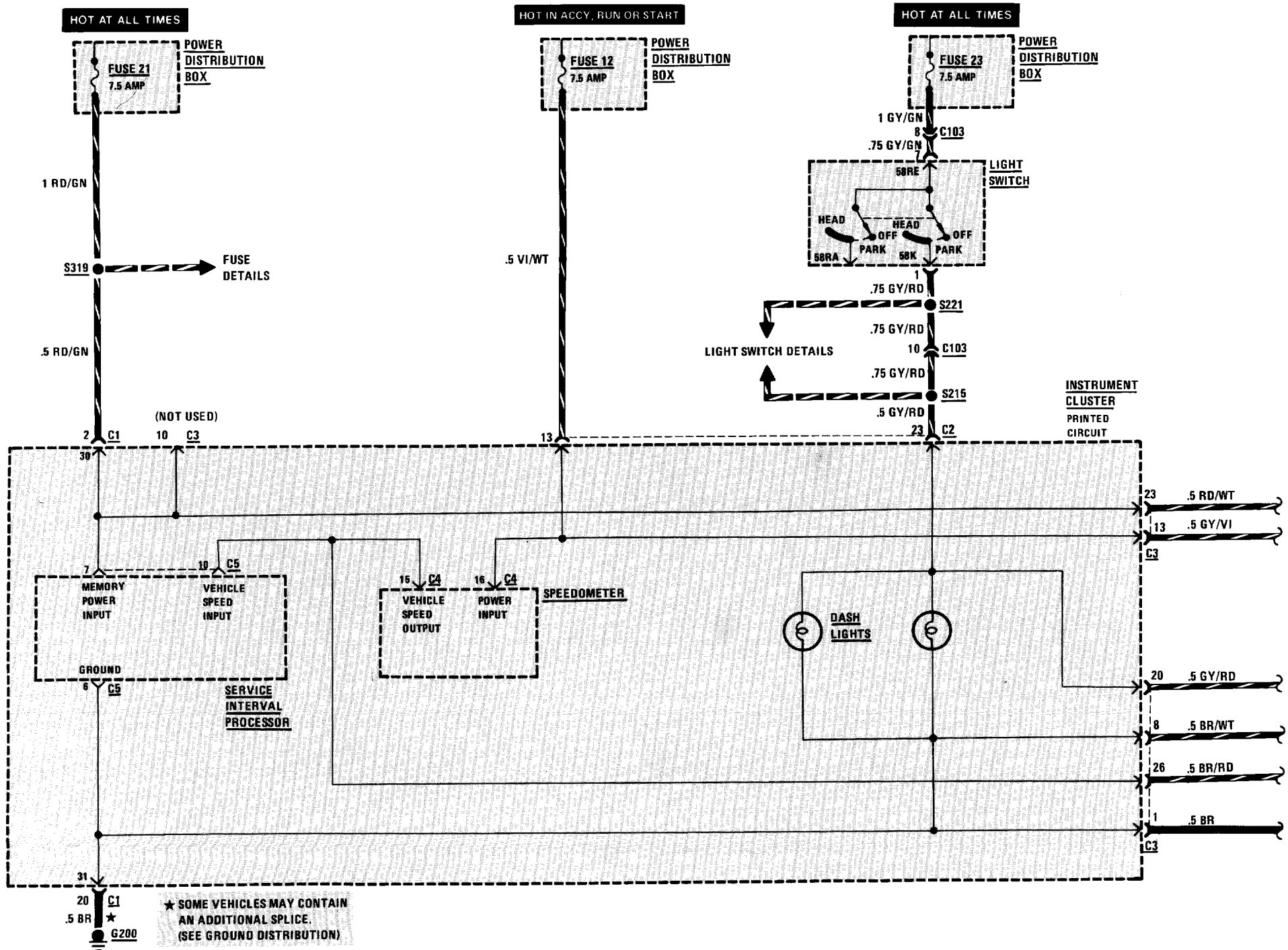

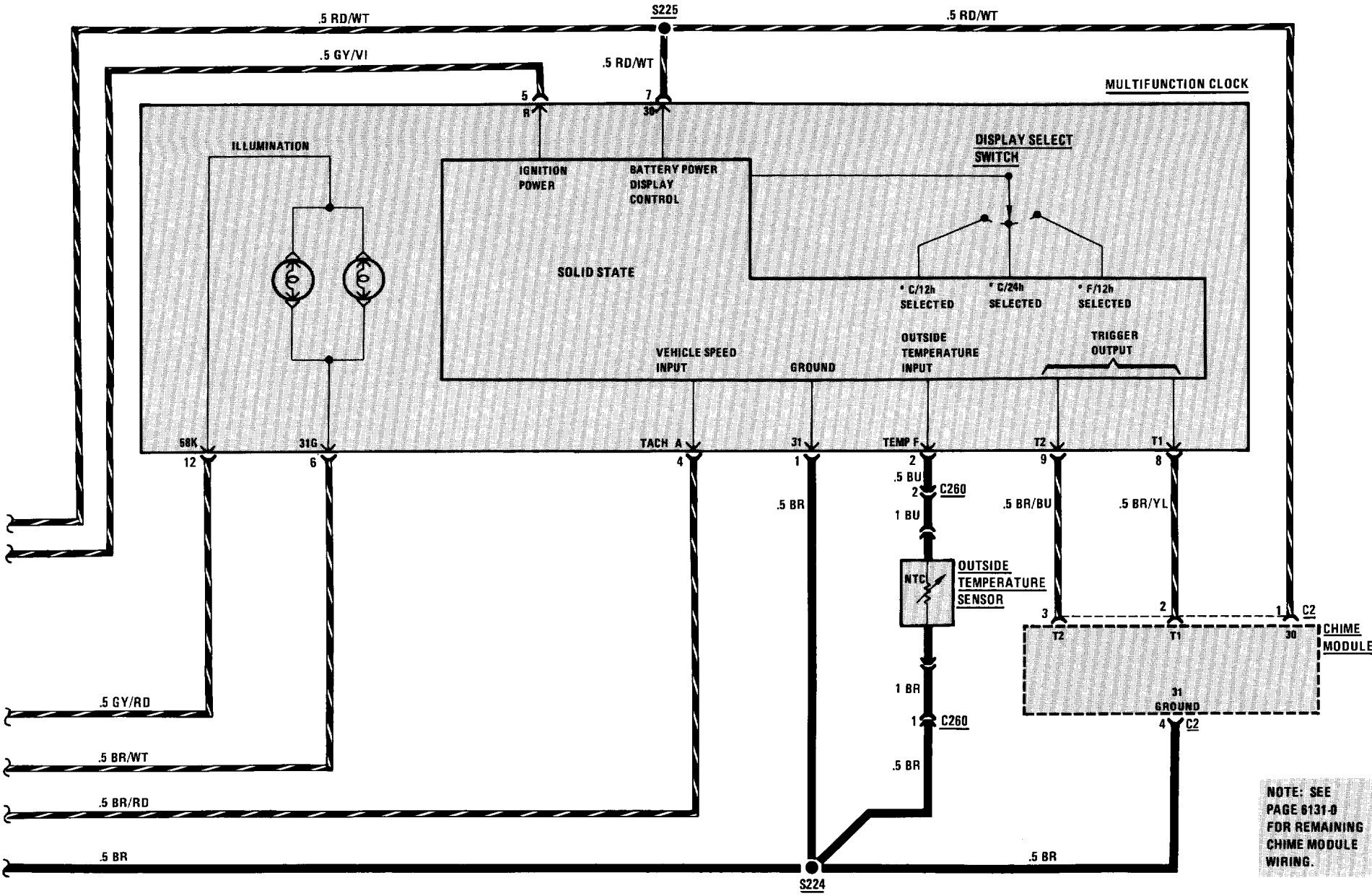

NOTE: SEE PAGE 6131-0 FOR REMAINING CHIME MODULE WIRING.

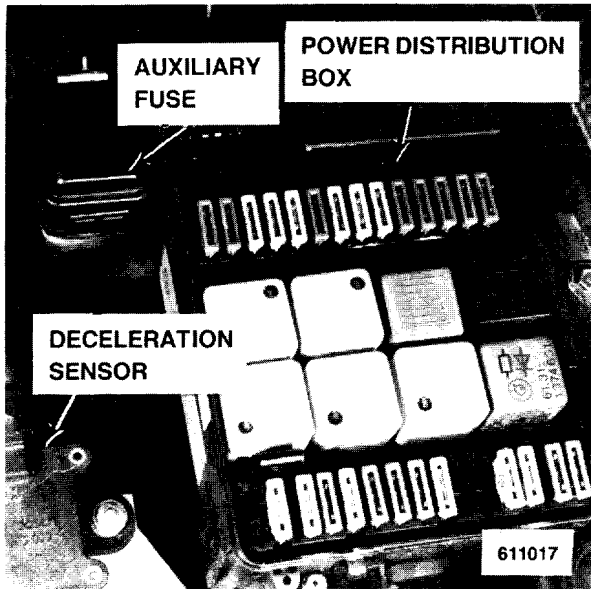

Figure 1 - LH Rear of Engine Compartment

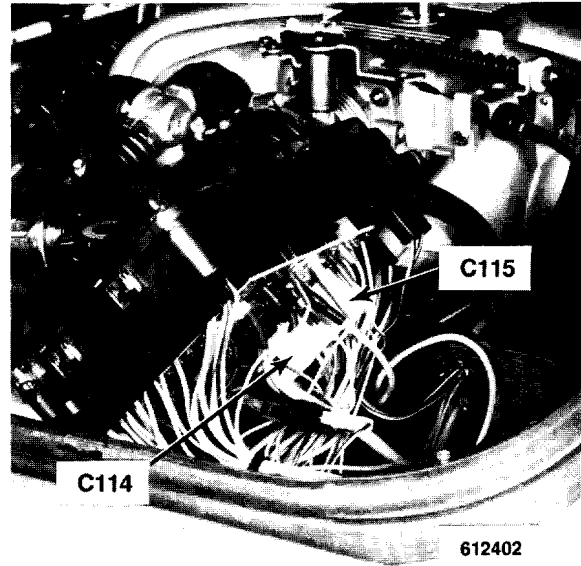

Figure 3 - LH Rear of Engine Compartment (Inside Power Distribution Box)

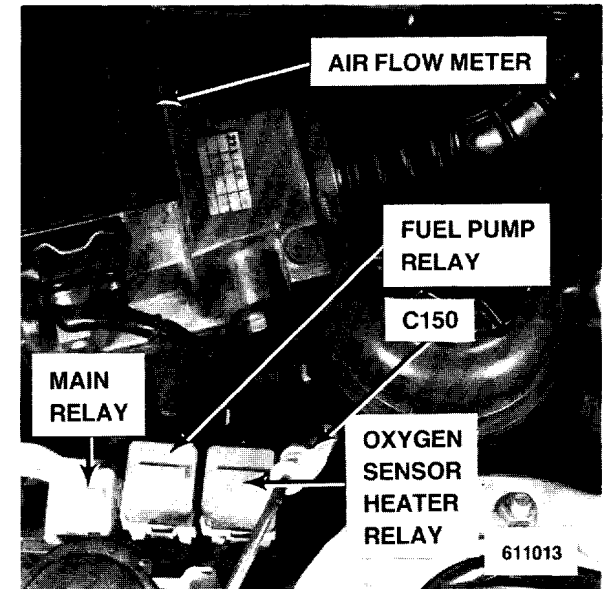

Figure 5 - Forward of LH Front Shock Tower (Relay Cover Removed)

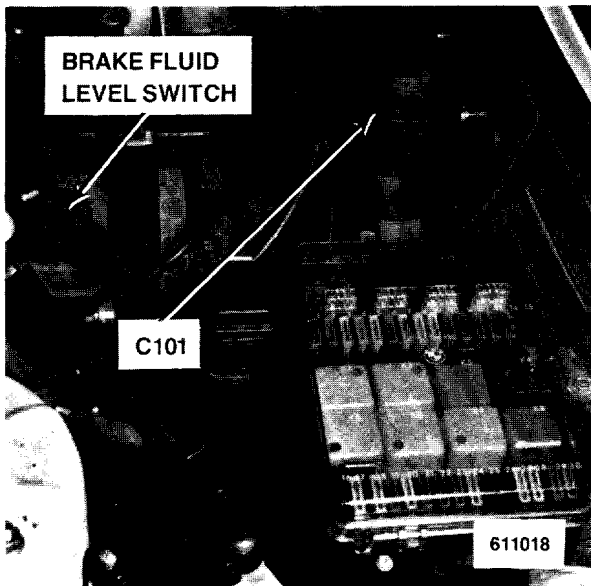

Figure 2 - LH Rear of Engine Compartment

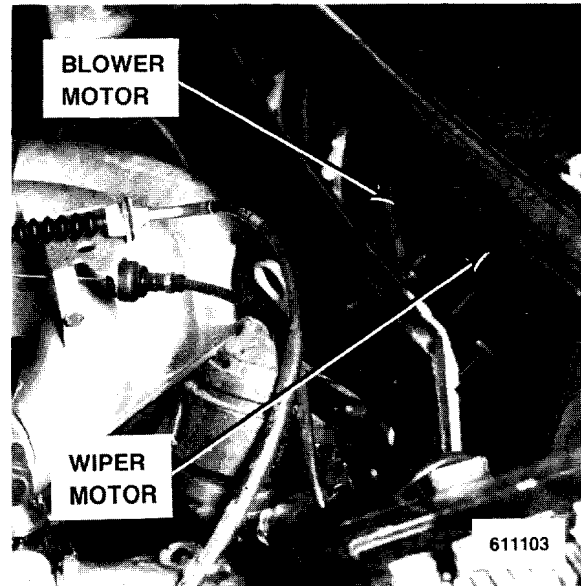

Figure 4 - Behind Cowl

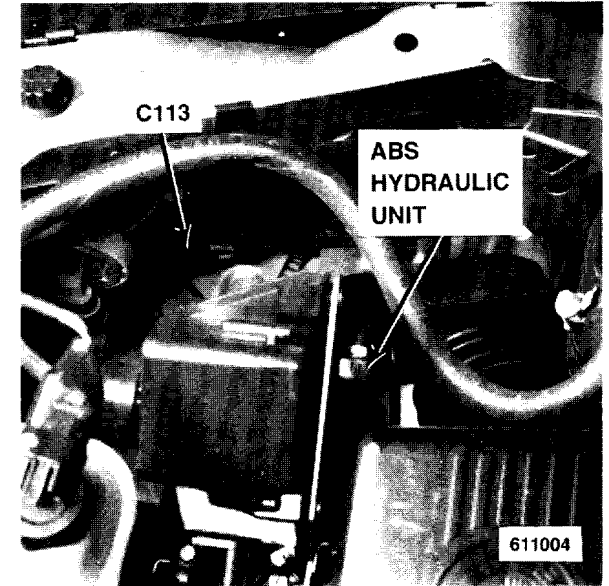

Figure 6 - LH Front of Engine Compartment

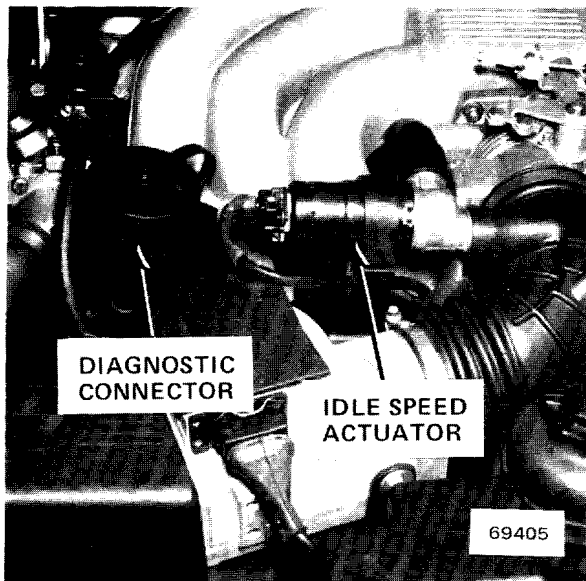

Figure 1 - LH Front of Engine

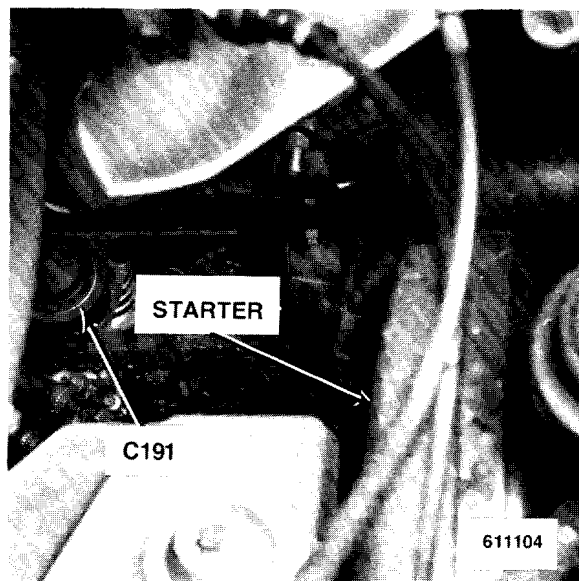

Figure 3 - Lower LH Rear of Engine

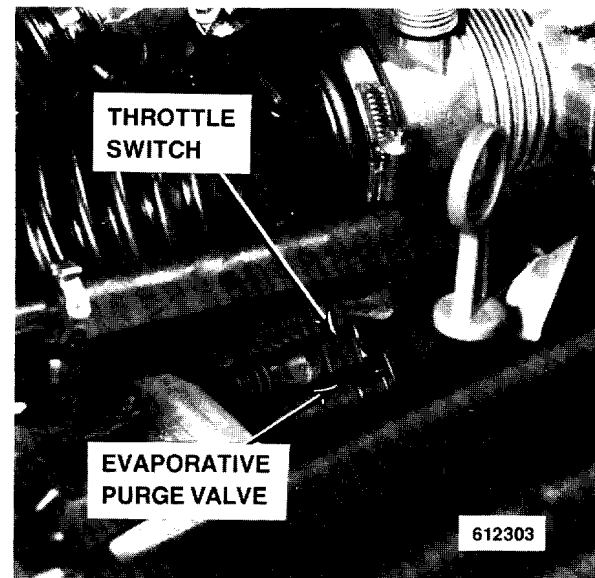

Figure 5 - LH Front of Engine

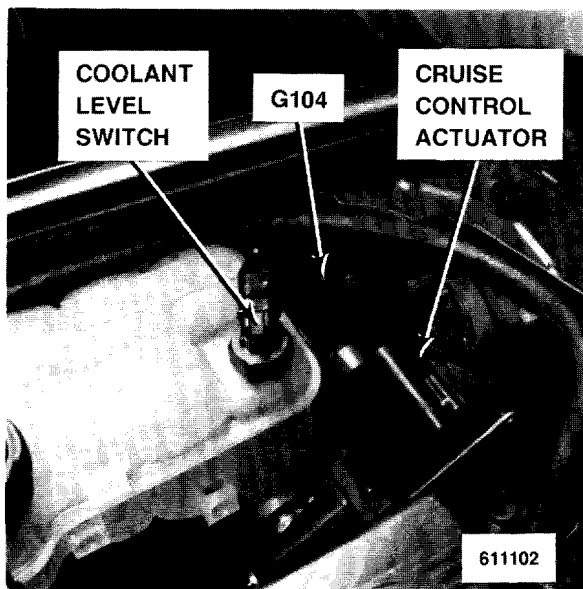

Figure 2 - Forward of LH Front Wheel Well

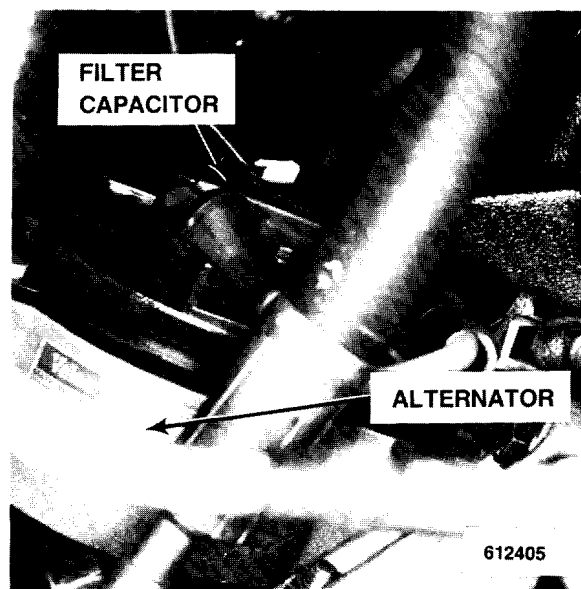

Figure 4 - Lower LH Front of Engine

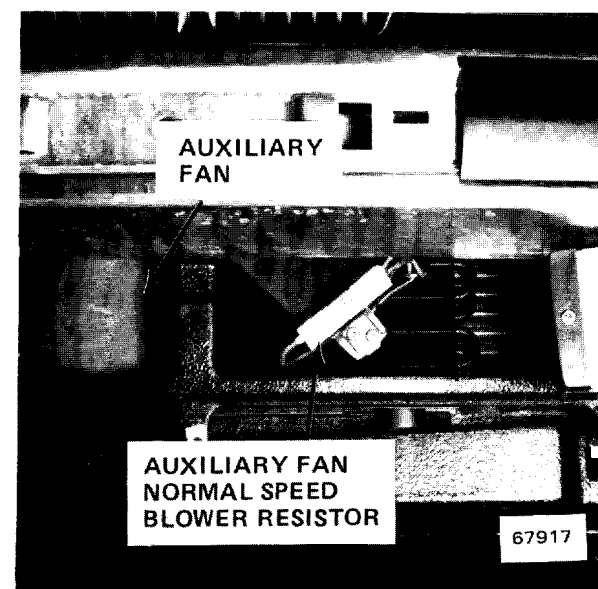

Figure 6 - Under Middle of Front Bumper

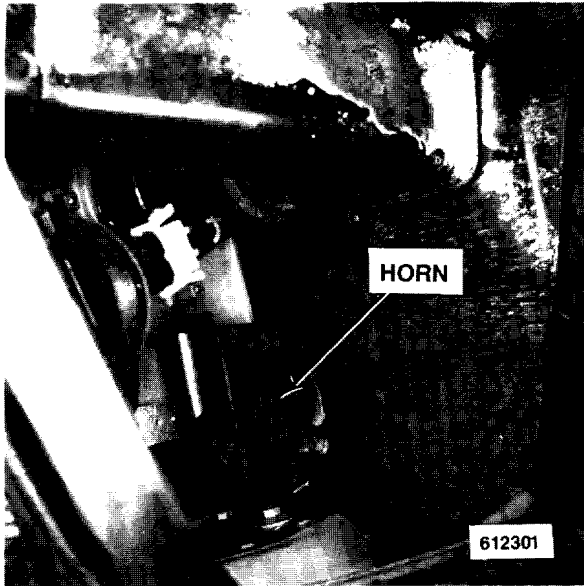

Figure 1 - Under LH and RH Side of Bumper

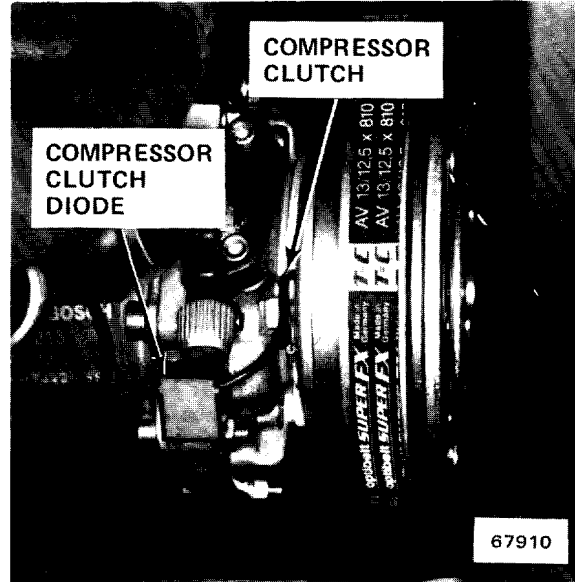

Figure 3 - Lower RH Front of Engine

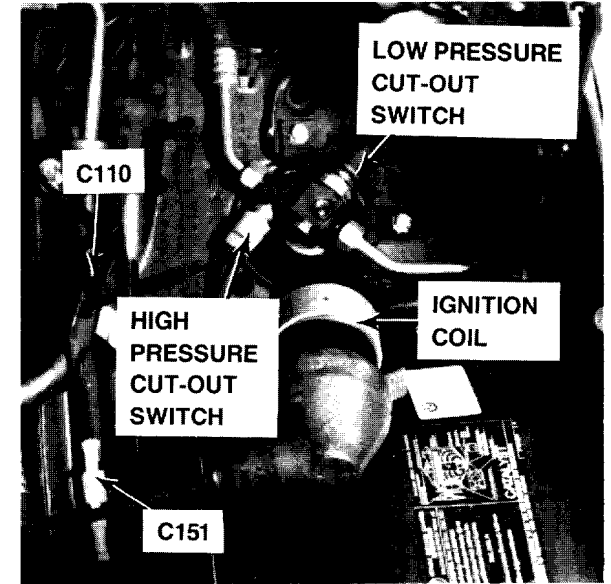

Figure 5 - RH Front of Engine Compartment

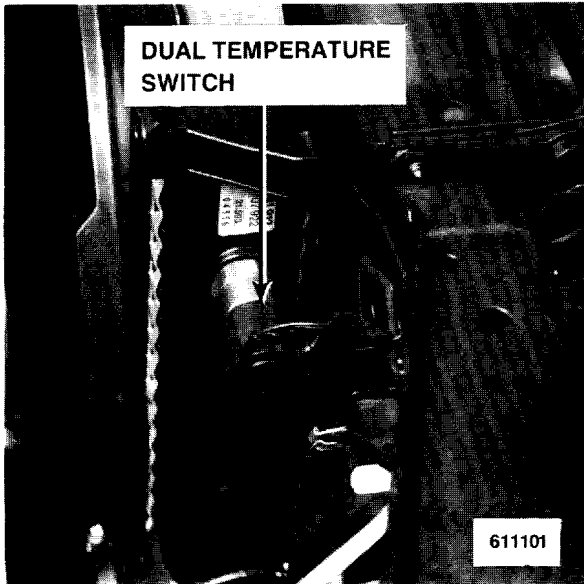

Figure 2 - Top RH Side of Radiator

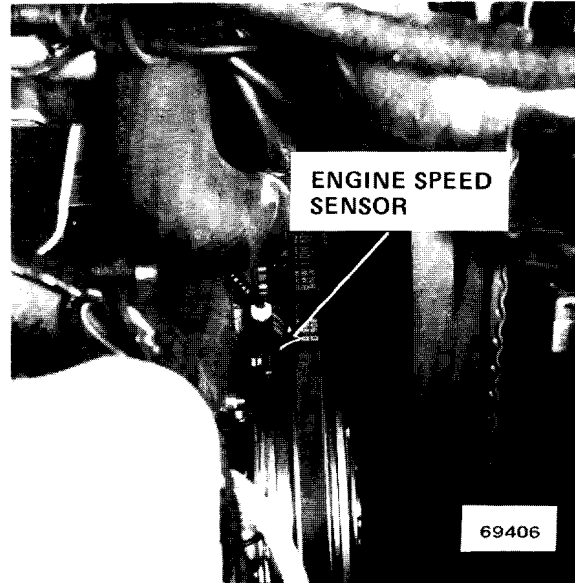

Figure 4 - Lower RH Front of Engine

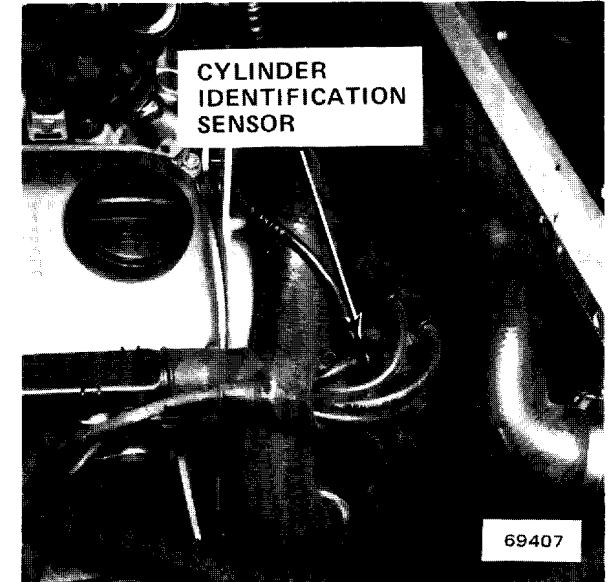

Figure 6 - RH Front of Engine (Cover Removed)

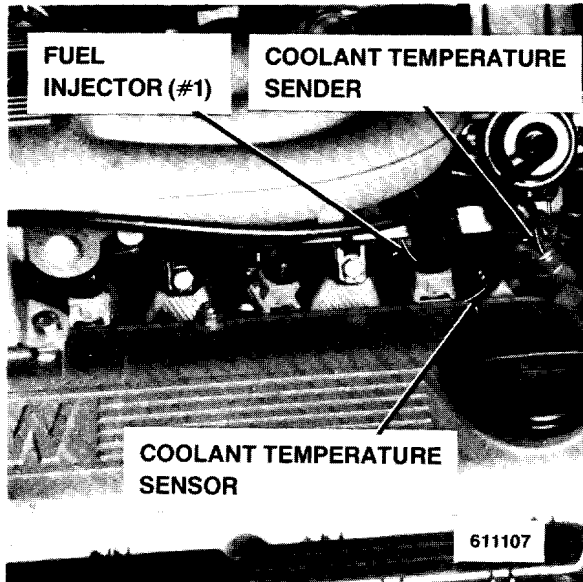

Figure 1 - Top Front of Engine

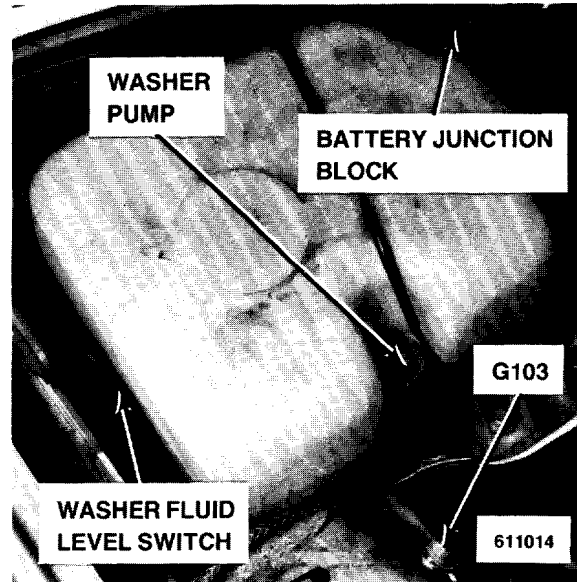

Figure 3 - RH Rear of Engine Compartment

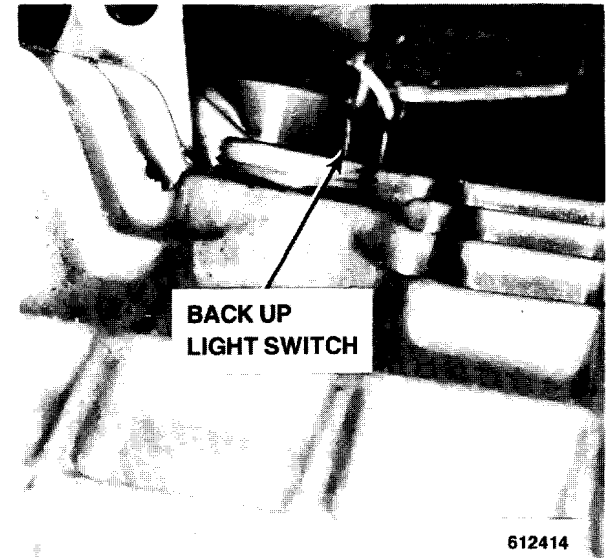

Figure 5 - RH Side of Transmission

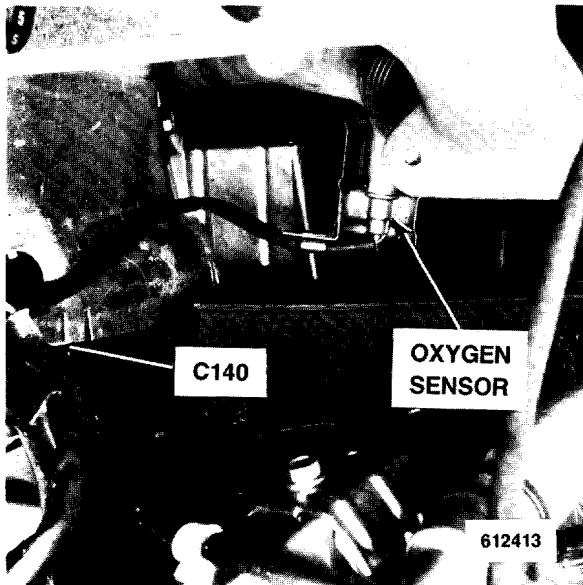

Figure 2 - Lower RH Rear of Engine

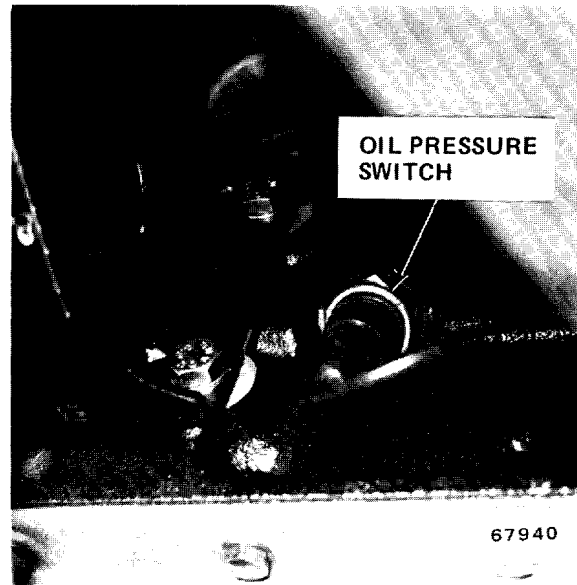

Figure 4 - Lower RH Front of Engine

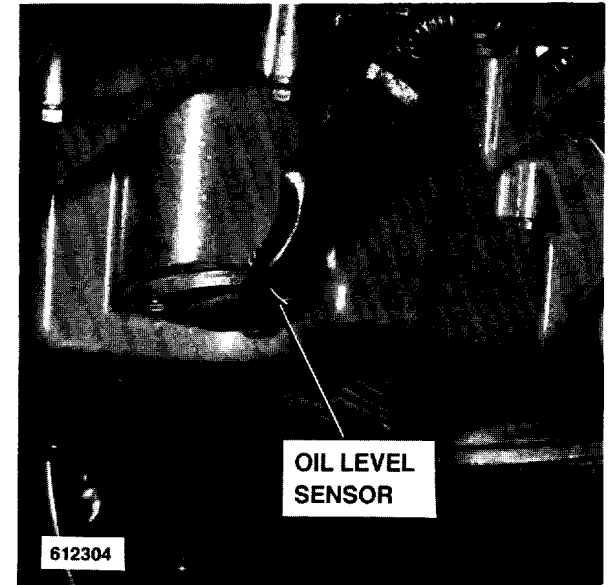

Figure 6 - Lower RH Side of Engine

7000-4 COMPONENT LOCATION VIEWS

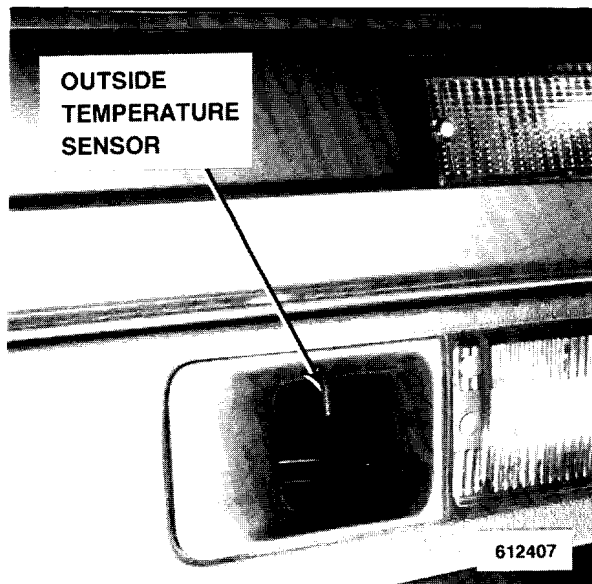

Figure 1 - Inside Air Intake, Near LH Fog Light

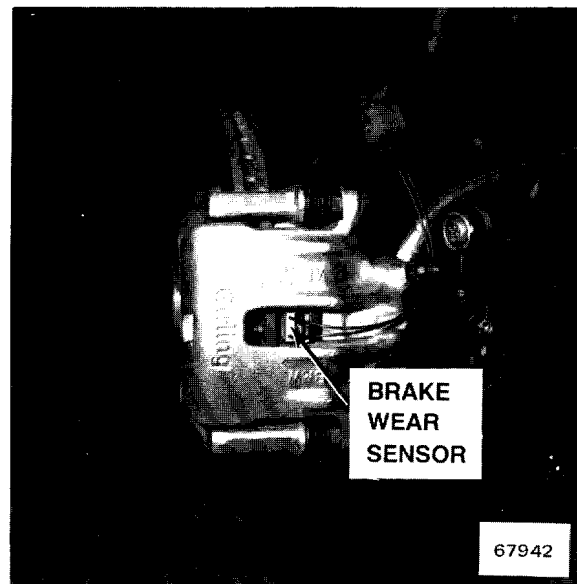

Figure 3 - LH Front Brake Assembly (Wheel Removed)

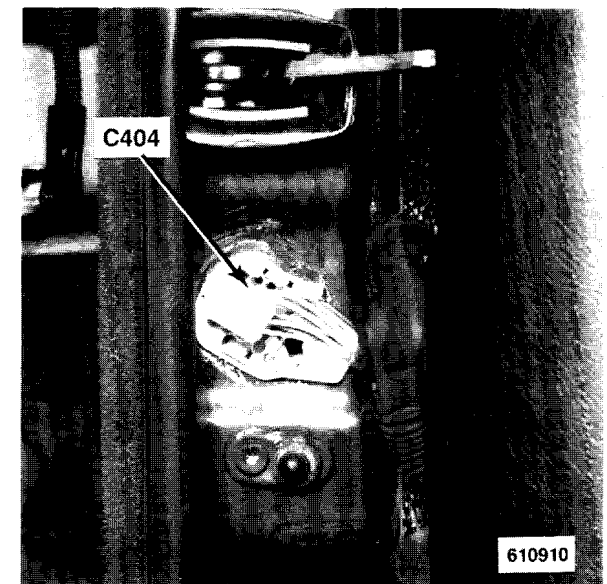

Figure 5 - Above RH Front Door Jamb Switch

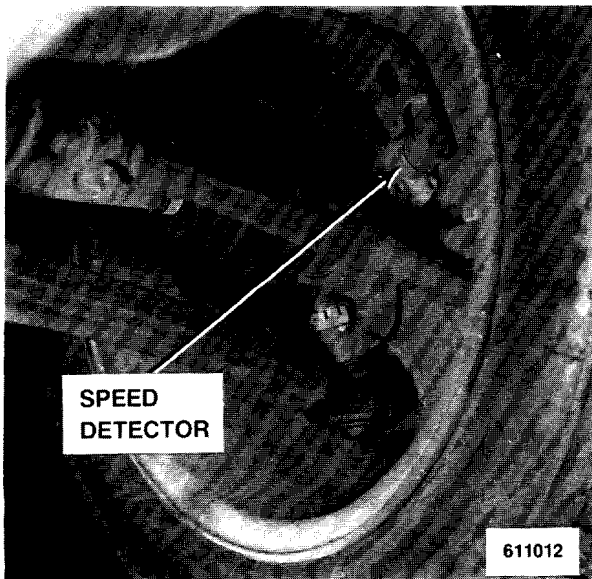

Figure 2 - Behind LH Front Wheel

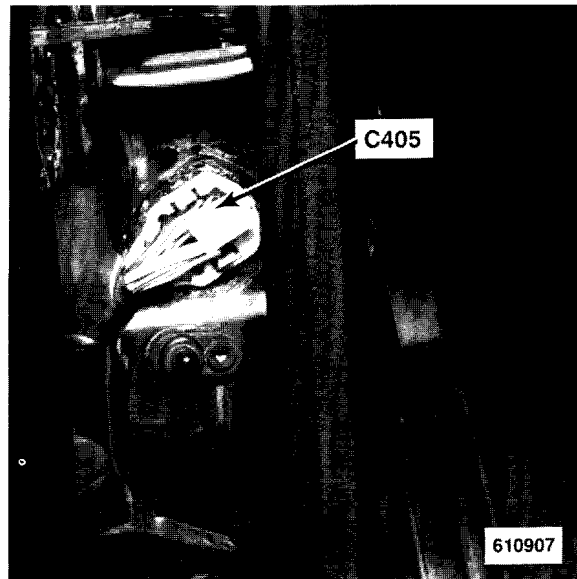

Figure 4 - Above LH Front Door Jamb Switch

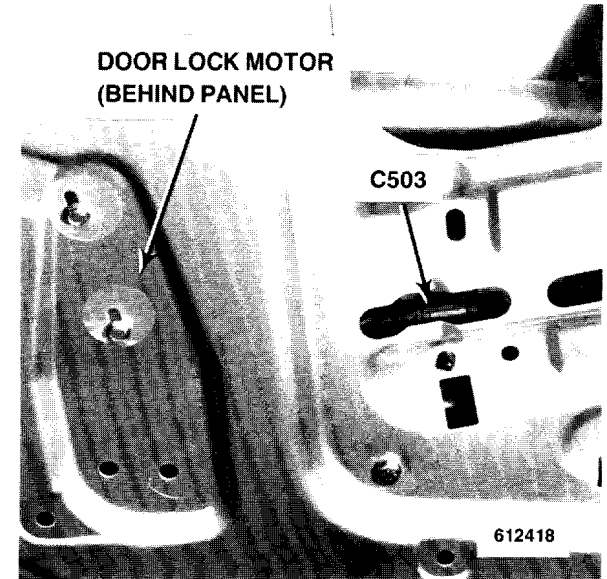

Figure 6 - Rear of LH Front Door

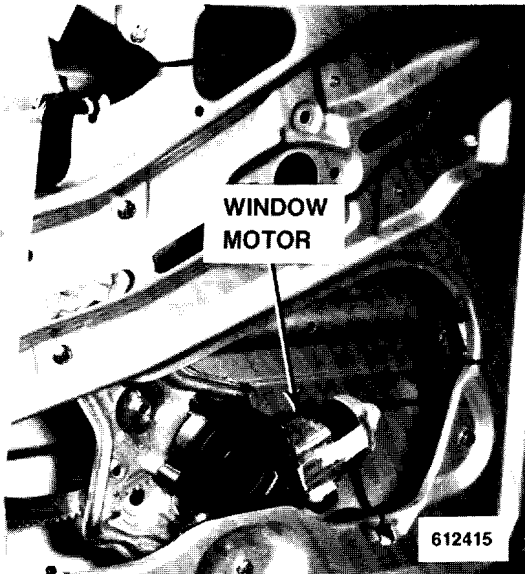

Figure 1 - Forward Part of LH Front Door

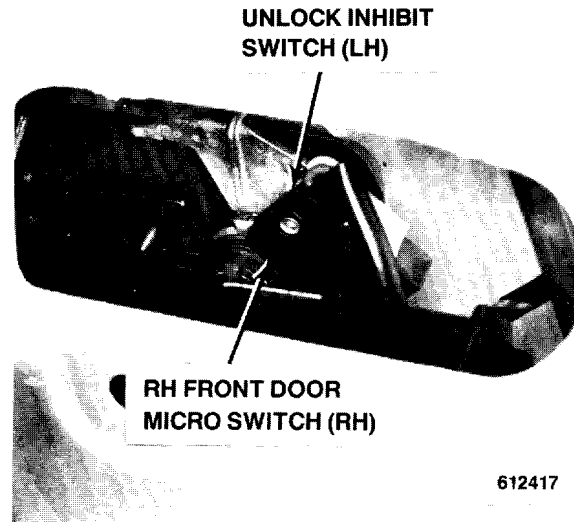

Figure 3 - Rear Part of LH Front Door

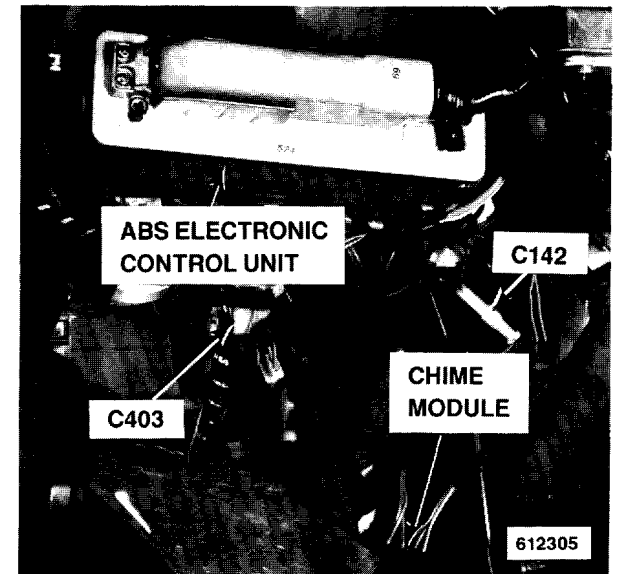

Figure 5 - Under LH Side of Dash



Figure 2 - Rear Part of LH Front Door

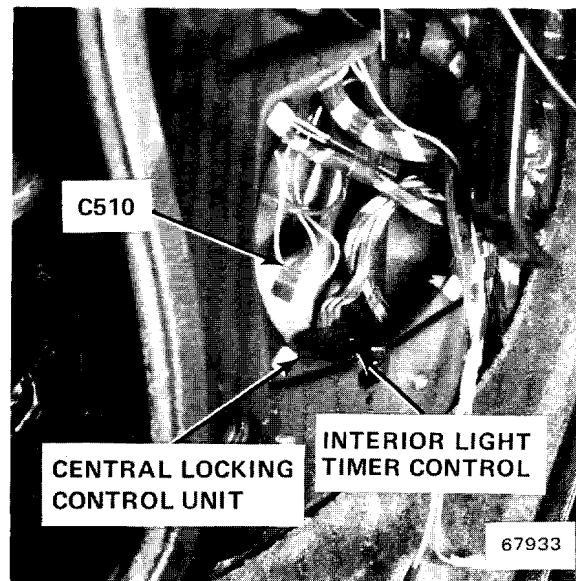

Figure 4 - Behind LH Front Speaker



Figure 6 - Under LH Side of Dash

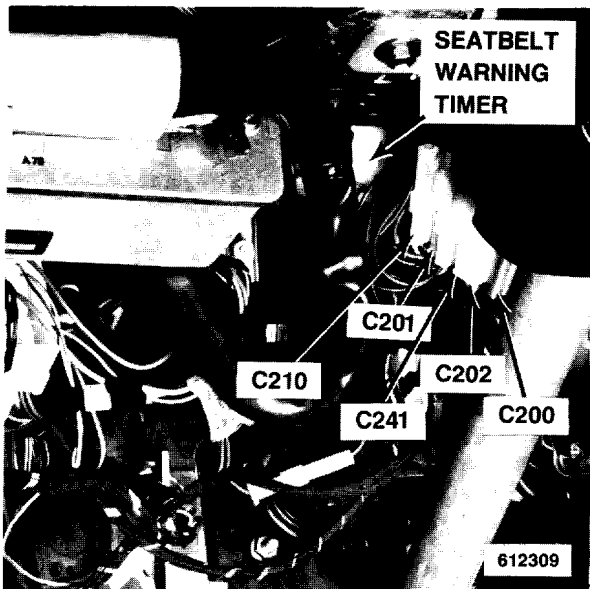

Figure 1 - Under LH Side of Dash

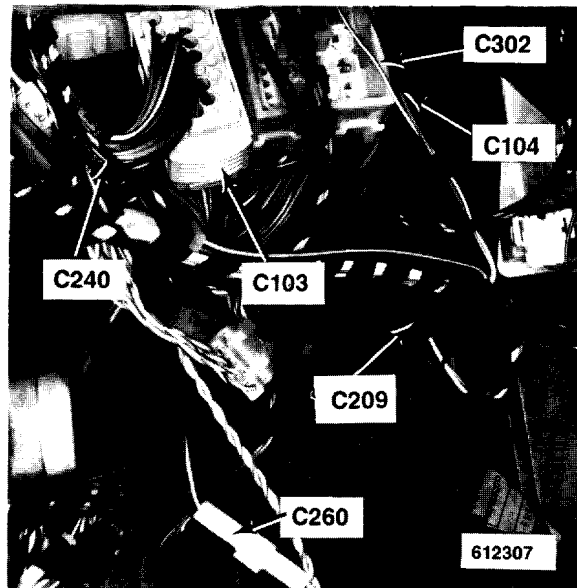

Figure 3 - Under LH Side of Dash

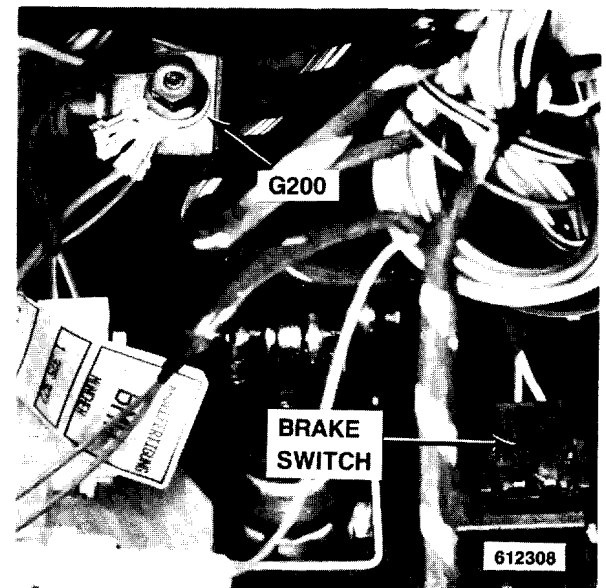

Figure 5 - Under LH Side of Dash

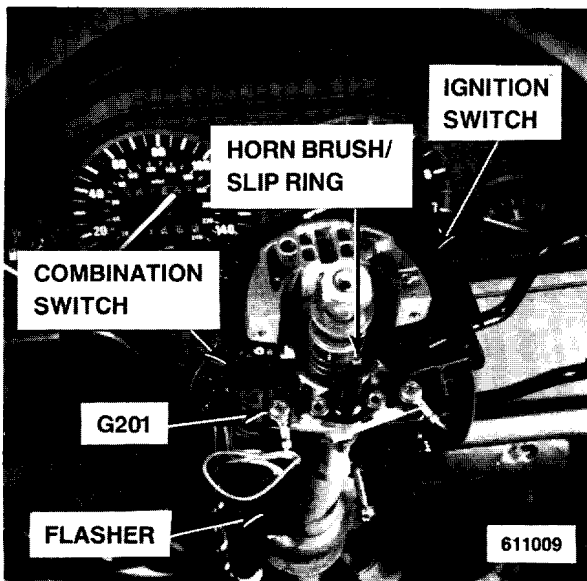

Figure 2 - Top of Steering Column

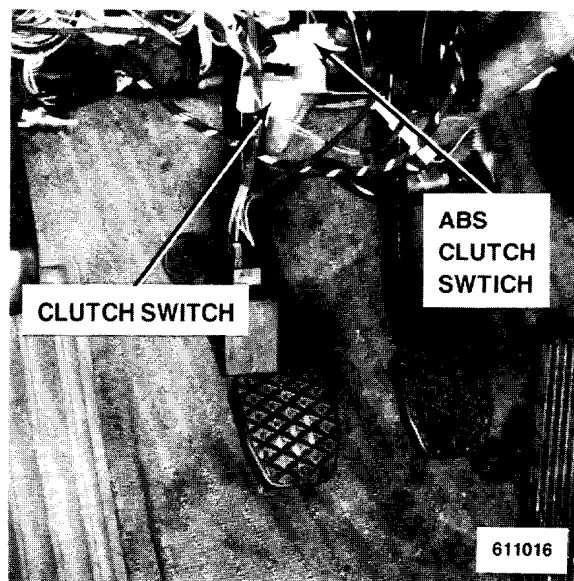

Figure 4 - Under LH Side of Dash



Figure 6 - Under LH Side of Dash

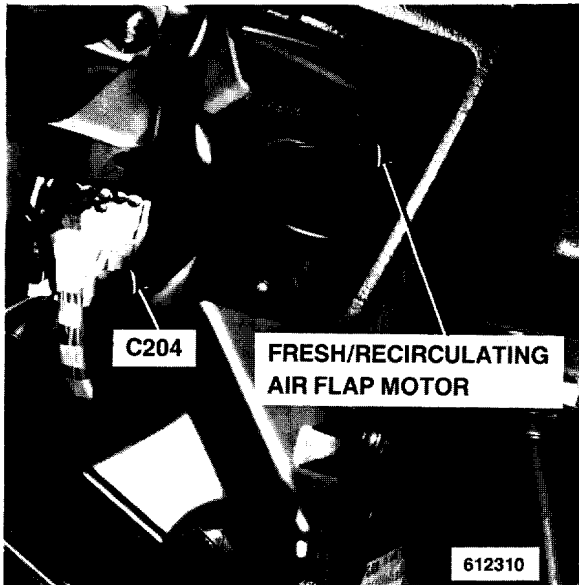

Figure 1 - Under LH Side of Dash

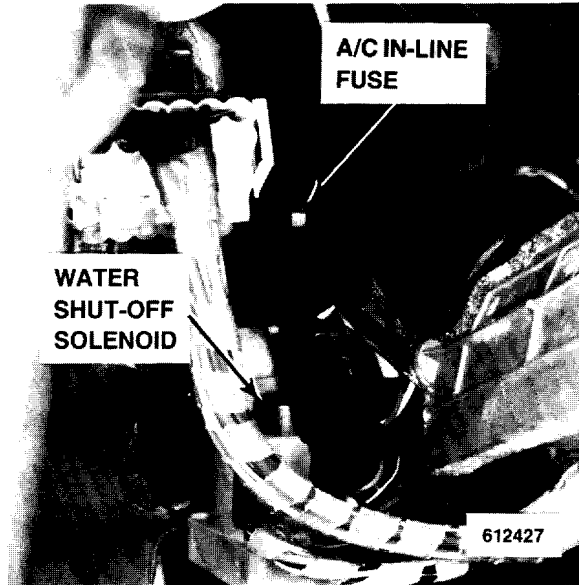

Figure 3 - LH Side of Evaporator Housing

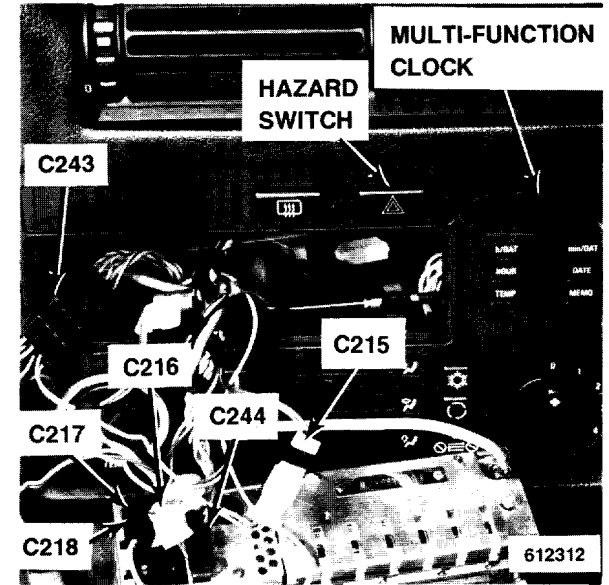

Figure 5 - Center of Dash

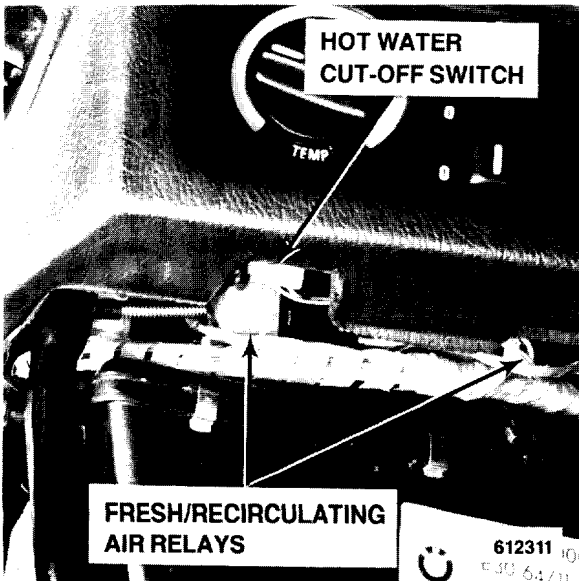

Figure 2 - Center of Dash

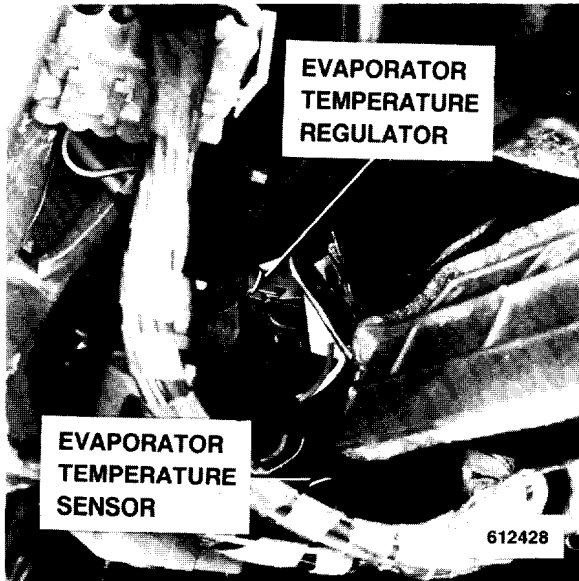

Figure 4 - LH Side of Evaporator Housing

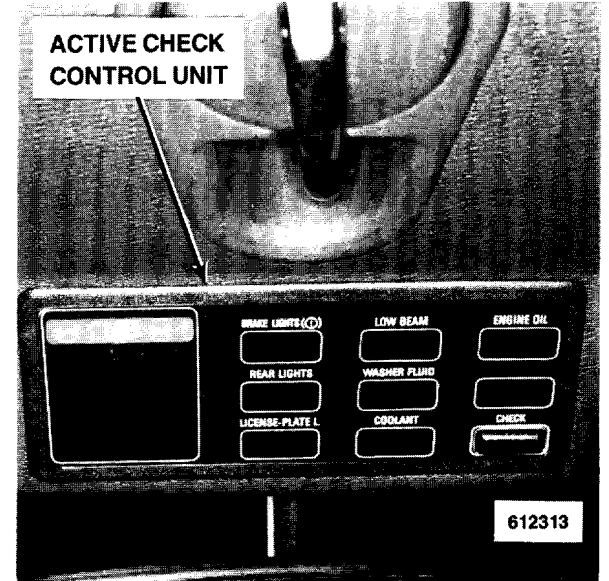

Figure 6 - Center of Windshield Header

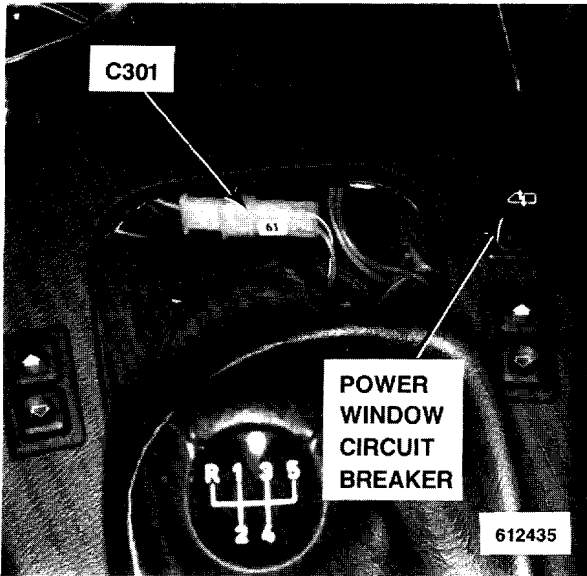

Figure 1 - Center Console

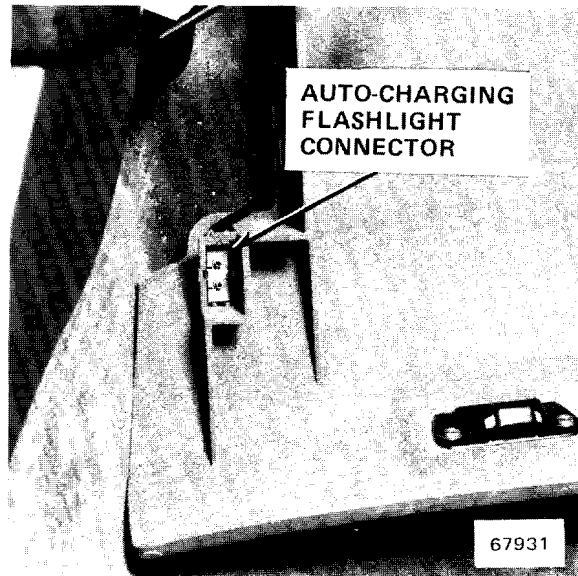

Figure 3 - Inside Glove Box



Figure 5 - In "B" Pillar

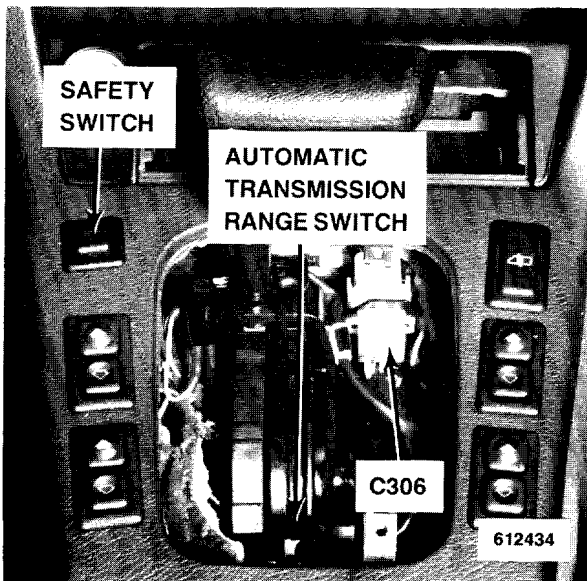

Figure 2 - Center Console

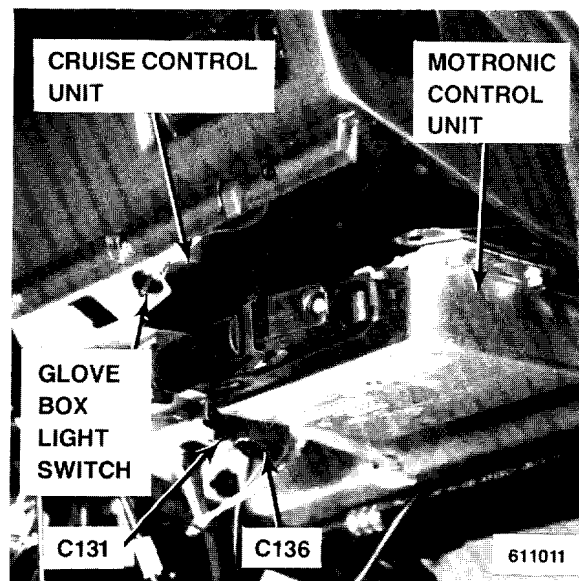

Figure 4 - Under RH Side of Dash

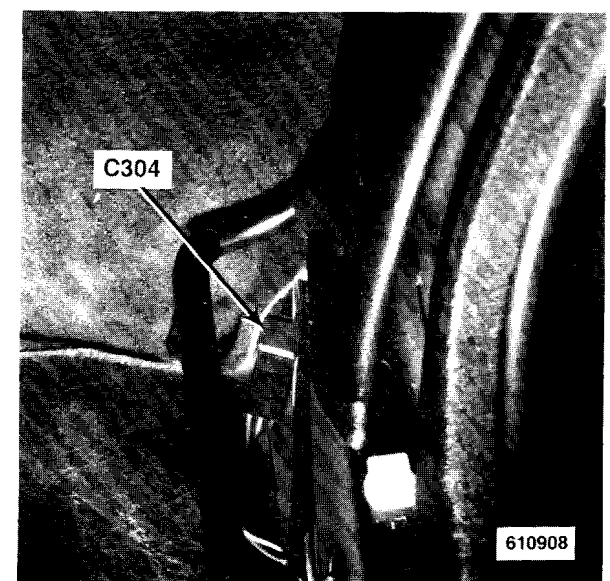

Figure 6 - At Bast of LH "B" Pillar

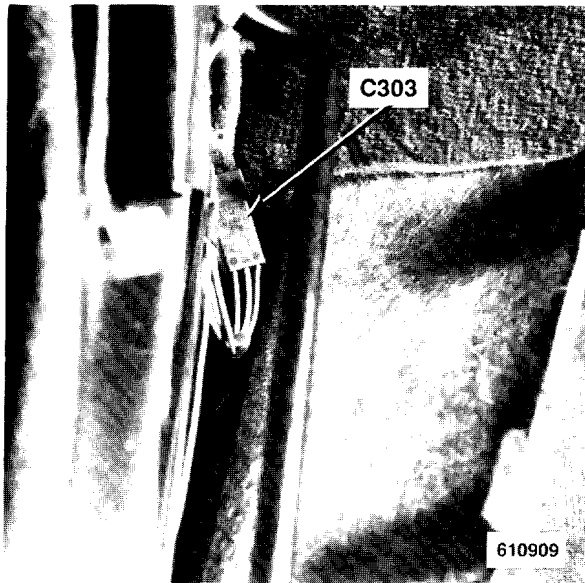

Figure 1 - At Base of RH "B" Pillar

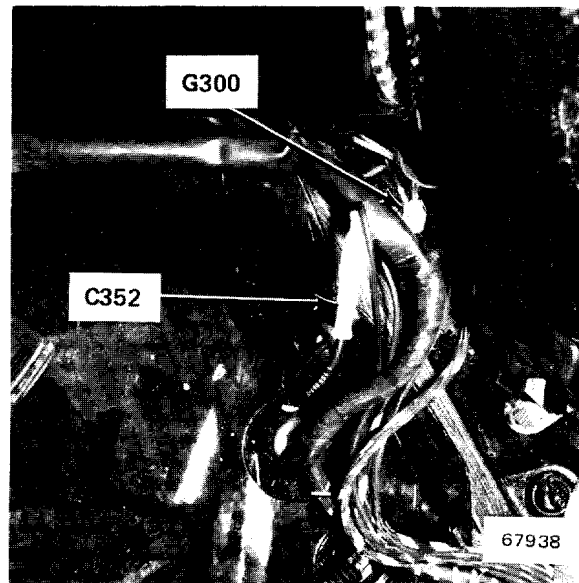

Figure 3 - Under LH Side of Rear Seat

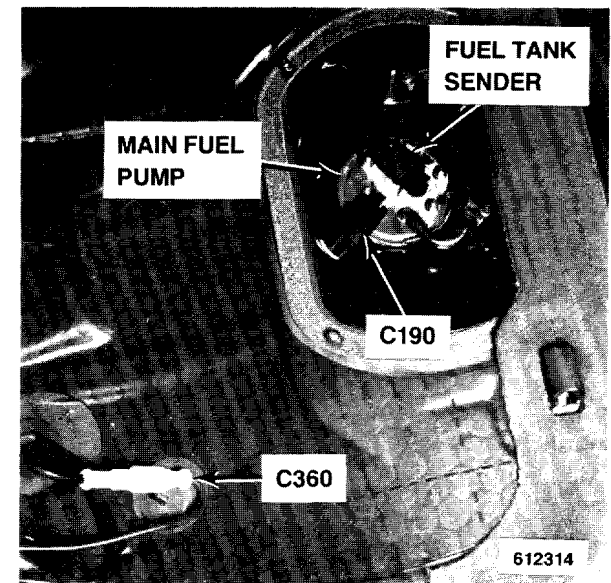

Figure 5 - Under RH Side of Rear Seat

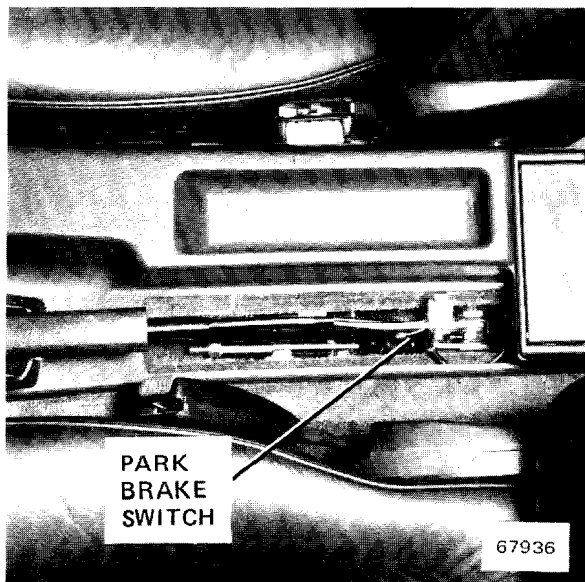

Figure 2 - Rear of Center Console

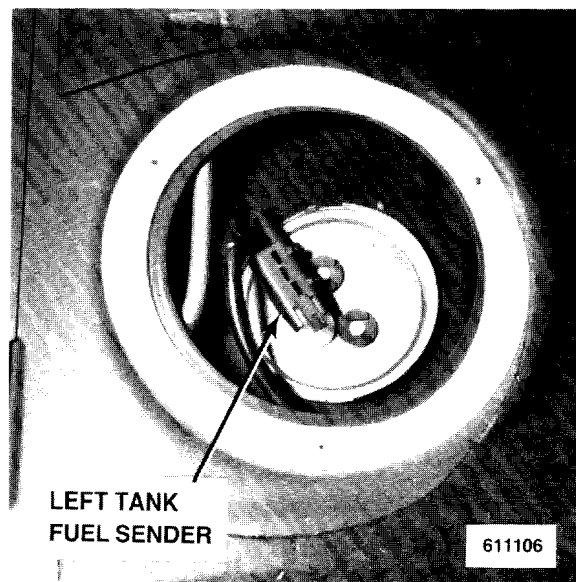

Figure 4 - Under LH Side of Rear Seat

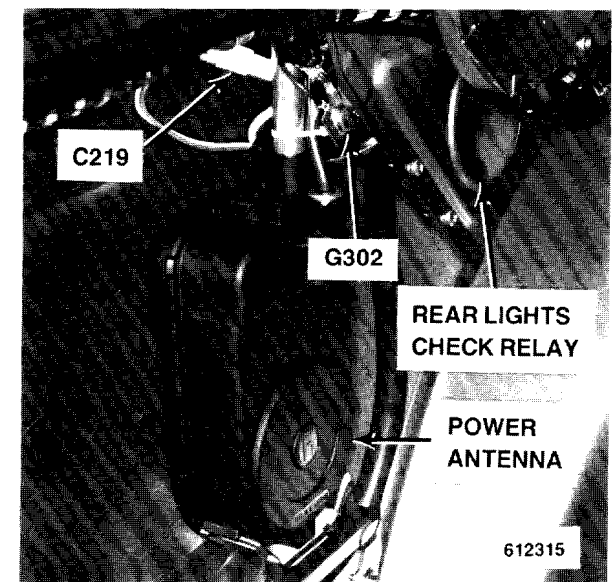

Figure 6 - LH Side of Trunk



Figure 1 - Middle Rear of Trunk

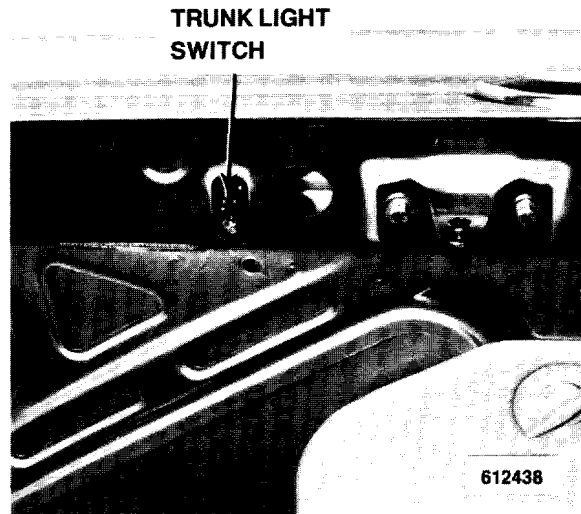

Figure 3 - Center of Trunk Lid

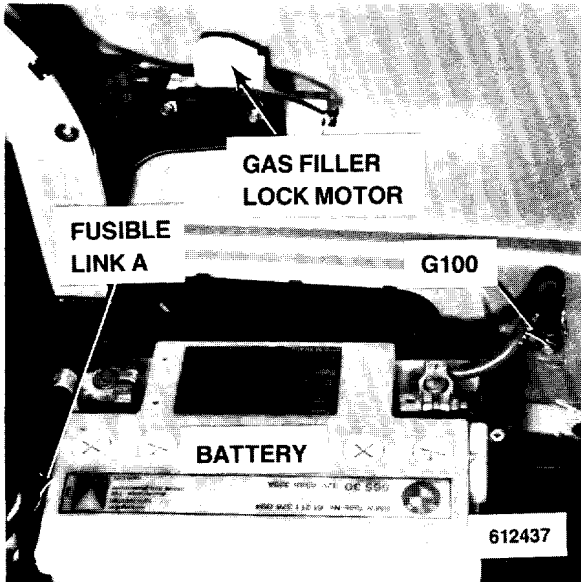

Figure 2 - RH Front of Trunk

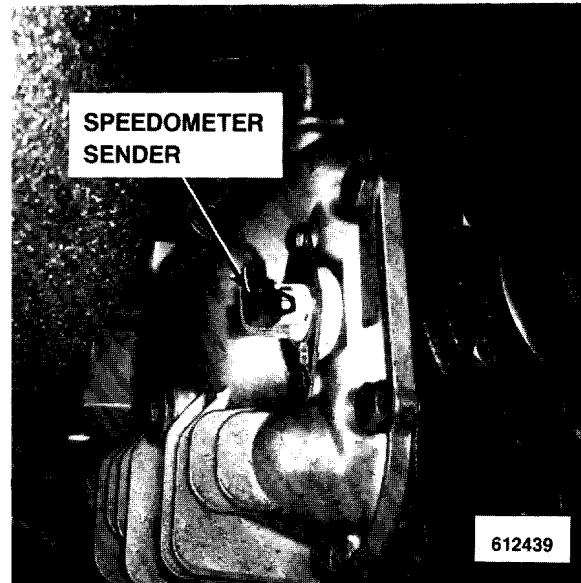

Figure 4 - RH Rear of Differential

8000-0 SPLICE LOCATION VIEWS

INDEX

This index lists all the splices in the vehicle, the harness location of each splice, and the page on which each splice appears. The drawings after the index show how the harnesses are routed through the vehicle and the location of the splices on the harnesses.

SPLICE	HARNESS	PAGE NUMBER	SPLICE	HARNESS	PAGE NUMBER
S100	MAIN	8000-2	S219	INSTRUMENT	
S101	ENGINE	8000-2		PANEL	8000-5
S103	MAIN	8000-2	S221	INSTRUMENT	
S104	ENGINE	8000-3		PANEL	8000-5
S105	ENGINE	8000-3	S223	CRUISE	NOT
S106	ENGINE	8000-3		CONTROL	SHOWN
S107	ENGINE	8000-3	S224	MULTI-	
S109	ENGINE	8000-3		FUNCTION	NOT
S111	ENGINE	8000-3		CLOCK	SHOWN
S112	ENGINE	8000-3	S225	MULTI-	
S113	ENGINE	8000-3		FUNCTION	NOT
S114	MAIN	8000-2		CLOCK	SHOWN
S115	MAIN	8000-2	S226	A/C	NOT
S116	MAIN	8000-2			SHOWN
S118	MAIN	8000-2	S228	CRUISE	NOT
S119	MAIN	8000-2		CONTROL	SHOWN
S120	ENGINE	8000-3	S229	AIR	NOT
S201	ON-BOARD			CONDITIONING	SHOWN
	COMPUTER	8000-6	S230	MAIN	8000-2
S202	ON-BOARD		S231	MAIN	8000-2
	COMPUTER	8000-6	S232	MAIN	8000-2
S207	MAIN	8000-2	S233	MAIN	8000-2
S209	MAIN	8000-2	S234	MAIN	8000-2
S210	MAIN	8000-2	S235	MAIN	8000-2
S211	MAIN	8000-2	S236	MAIN	8000-2
S212	MAIN	8000-2	S237	MAIN	8000-2
S213	MAIN	8000-2	S238	MAIN	NOT
S215	MAIN	8000-2			SHOWN

INDEX

SPLICE	HARNESS	PAGE NUMBER	SPLICE	HARNESS	PAGE NUMBER
S239	MAIN	8000-2	S340	MAIN	8000-2
S240	AIR	NOT	S341	MAIN	8000-2
	CONDITIONING	SHOWN	S342	DOOR	8000-4
S241	MAIN	8000-2	S345	RADIO	NOT
S250	AIR	NOT			SHOWN
	CONDITIONING	SHOWN	S400	RADIO	NOT
S251	AIR	NOT			SHOWN
	CONDITIONING	SHOWN	S402	DOOR	8000-4
S252	AIR	NOT	S403	RADIO	NOT
	CONDITIONING	SHOWN			SHOWN
S300	DOOR	8000-4	S404	RADIO	NOT
S301	DOOR	8000-4			SHOWN
S302	DOOR	8000-4	S411	DOOR	8000-4
S303	DOOR	8000-4	S420	RADIO	NOT
S305	DOOR	8000-4			SHOWN
S306	INSTRUMENT		S501	DOOR	8000-4
	PANEL	8000-5	S502	DOOR	8000-4
S307	INSTRUMENT		S503	DOOR	8000-4
	PANEL	8000-5	S504	DOOR	8000-4
S309	DOOR	8000-4	S540	HEATED SEATS	NOT
S310	MAIN	8000-2			SHOWN
S313	RADIO	NOT	S541	HEATED SEATS	NOT
		SHOWN			SHOWN
S316	MAIN	8000-2	S542	HEATED SEATS	NOT
S319	MAIN	8000-2			SHOWN
S322	DOOR	8000-4	S543	HEATED SEATS	NOT
S323	DOOR	8000-4			SHOWN
S324	MAIN	8000-2	S700	ENGINE	8000-3
S326	MAIN	8000-2	S701	ENGINE	8000-3
S329	MAIN	8000-2	S702	ENGINE	8000-3
S330	MAIN	8000-2	S704	ENGINE	8000-3
S332	DOOR	8000-4			
S333	DOOR	8000-4			

8000-2 SPLICE LOCATION VIEWS

MAIN HARNESS SPLICE LOCATIONS

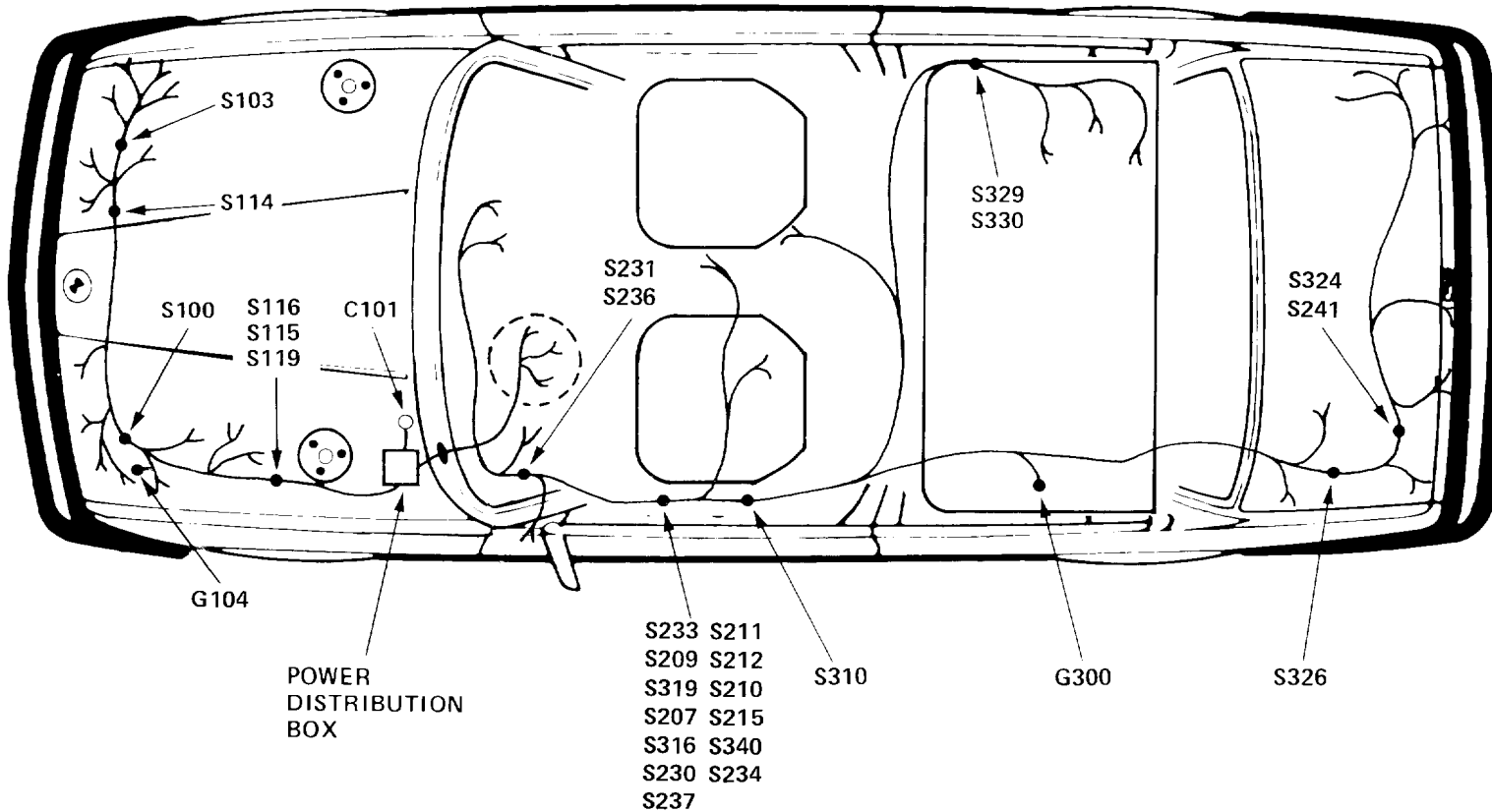
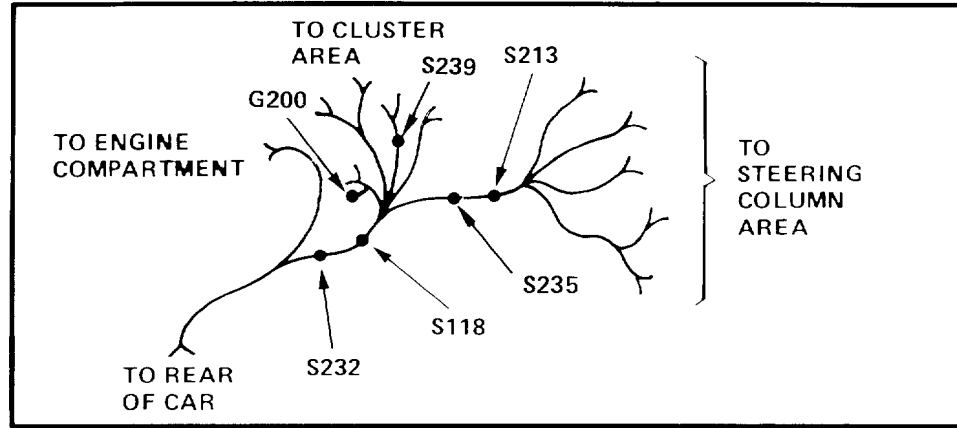

ENGINE HARNESS SPLICE LOCATIONS

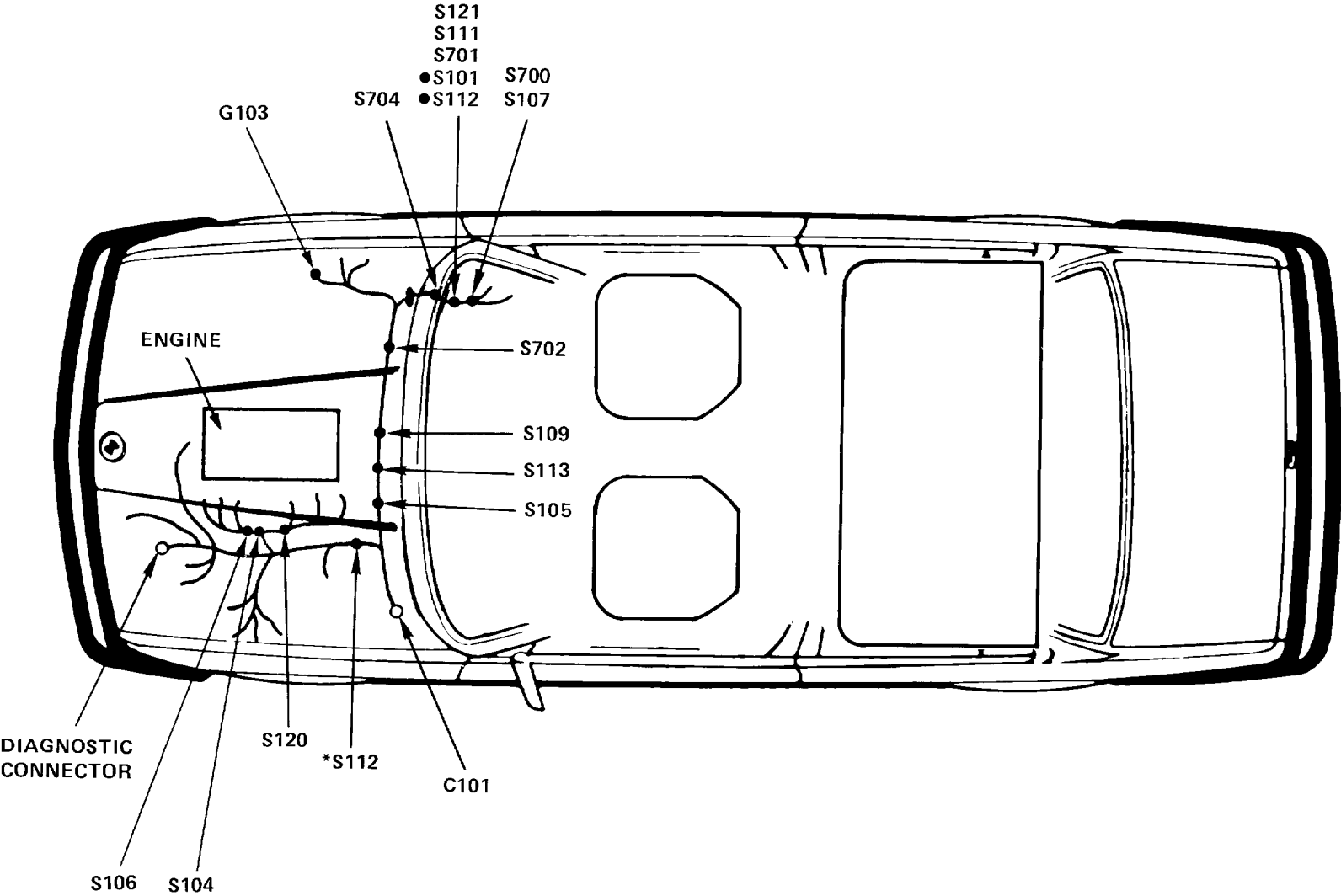

*EARLY PRODUCTION
●LATE PRODUCTION

8000-4 SPLICE LOCATION VIEWS

DOOR HARNESS SPLICE LOCATIONS

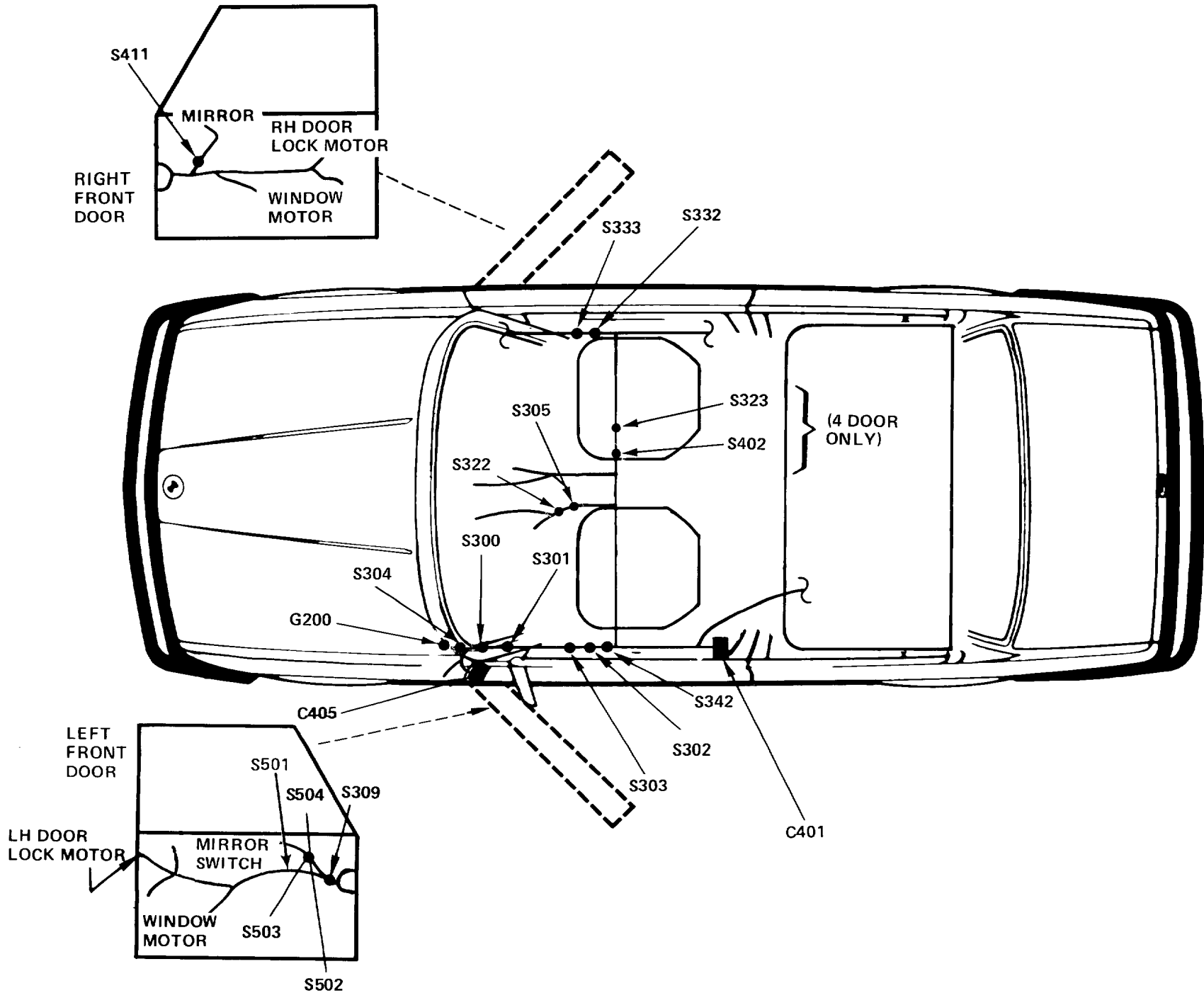

INSTRUMENT PANEL HARNESS SPLICE LOCATION

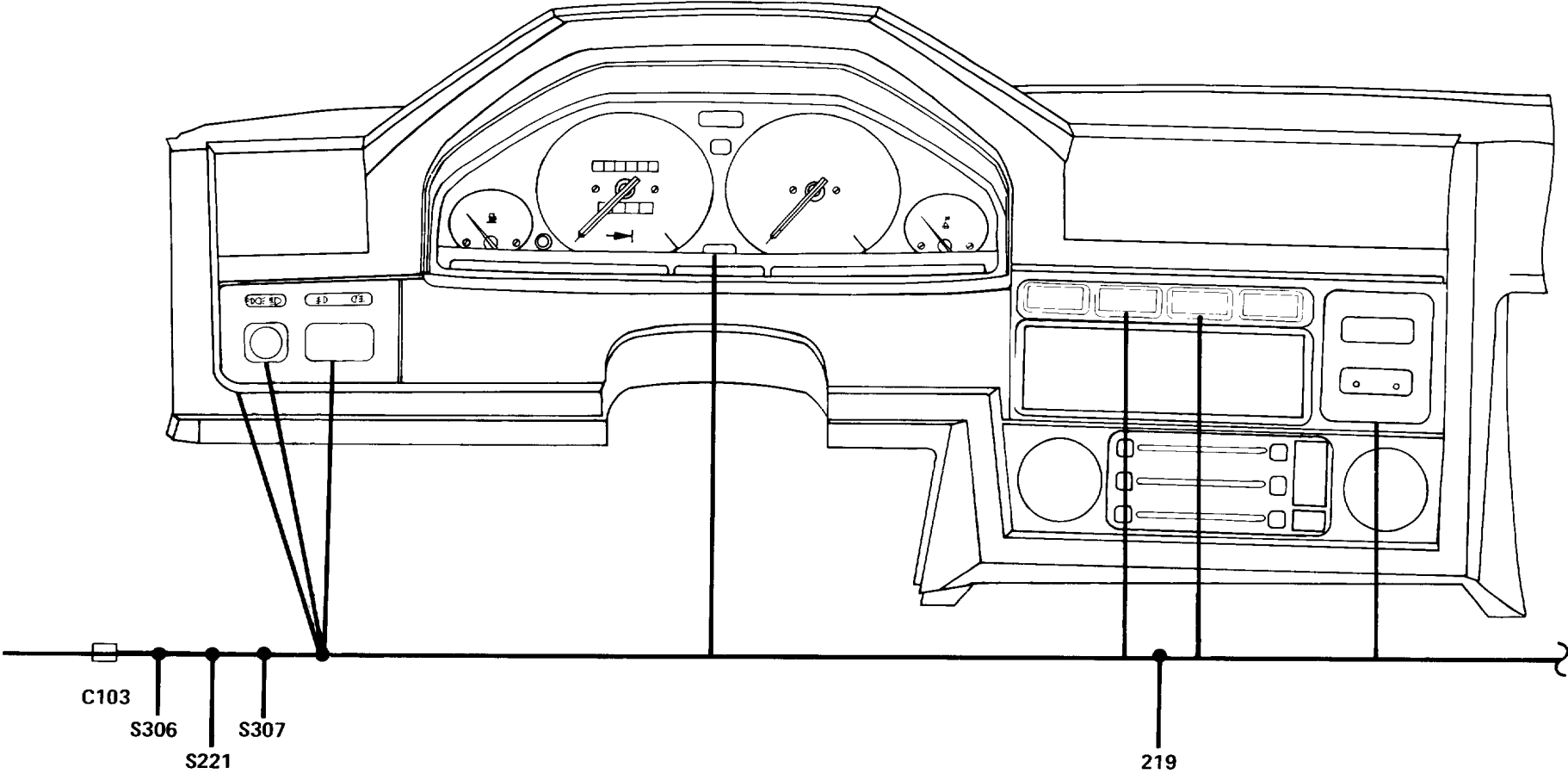

8000-6 SPLICE LOCATION VIEWS

ON-BOARD COMPUTER HARNESS SPLICE LOCATIONS

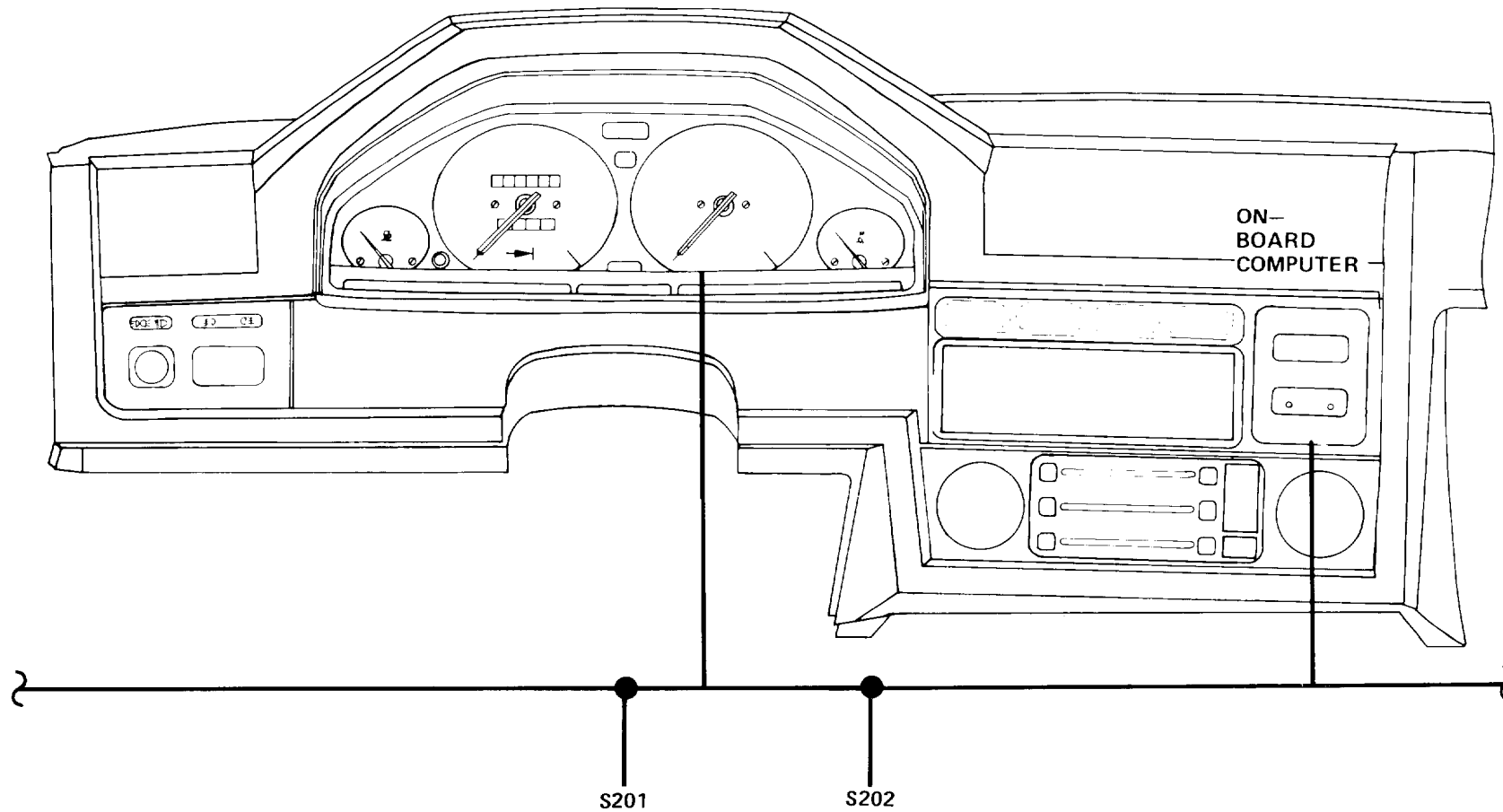

DIAGNOSTIC CONNECTOR

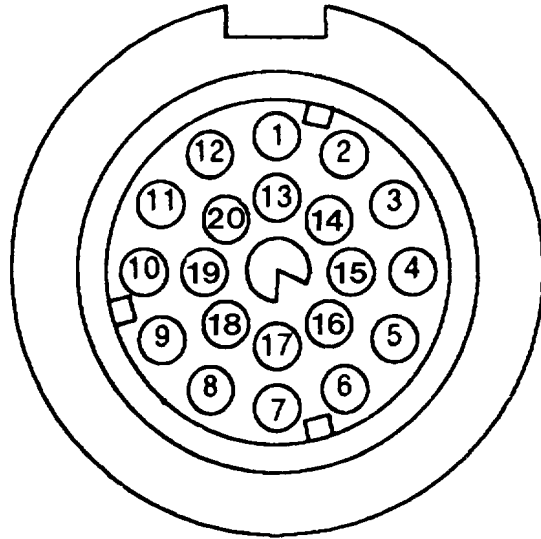

DIAGNOSTIC CONNECTOR FACE

Pin	Wire Size	Wire Color	Circuit and Component Connected
1	1	BK	Ignition Coil, Motronic Control Unit
6	.5	WT/BK	SRS Connector (Not Used)
7	.5	WT/GN	Service Interval Indicator, Service Interval Processor (Reset)
11	2.5	BK/YL	Starter, Start Signal (50)
12	.75	BU	Charge, Alternator (D+)
14	2.5	RD	Battery (+)
15	.5	WT/YL	Motronic Control Unit (RXD)
16	1.5	GN/WT	Oxygen Sensor
18	.5	GN/BU	Motronic Control Unit (Programming Voltage)
19	1.5 BR	BR	Ground Distribution (G103)
20	.5	WT/VI	Motronic Control Unit (TXD)

ACCESSORY CONNECTOR

CIRCUITS USING C302 (ACCESSORY CONNECTOR)

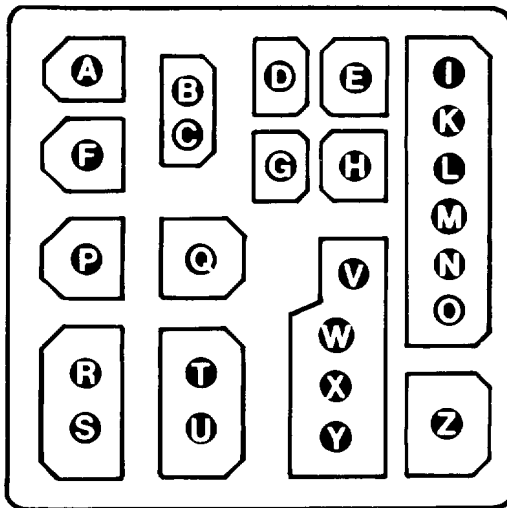
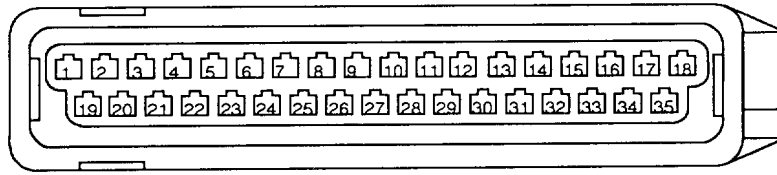

Figure 1-C302 (Accessory Connector)
Front View—Under LH Side
of Dash Ahead of Pedal Assembly

TERMINAL	CIRCUIT	TERMINAL	CIRCUIT
A	Not Used	N	Not Used
B	Not Used	O	Not Used
C	Anti-Lock Braking	P	Not Used
D	Central Locking	Q	Power Windows & Sunroof
E	Not Used	R	Cruise Control
F	Not Used	S	Anti-Lock Braking
G	Anti-Lock Braking	T	Not Used
H	On-Board Computer	U	Not Used
I	Not Used	V	Radio
J	Not Used	W	Radio
K	Not Used	X	Radio
L	Not Used	Y	Radio
M	Not Used	Z	Power Antenna

8500-2 CONNECTOR VIEWS

B350002.04



Mating Face
ABS CONTROL UNIT

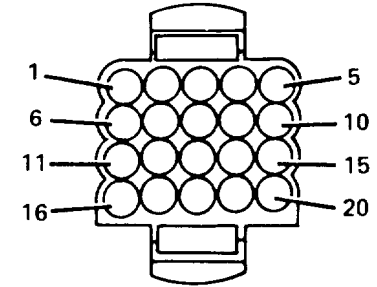

Wiring Face
AMPLIFIER
(SOUND SYSTEM)

B120014

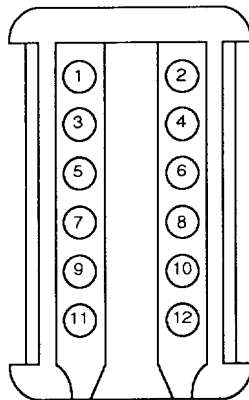

Wiring Face
ABS HYDRAULIC UNIT

B090001.14

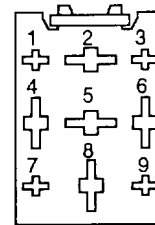

Mating Face
ABS NEUTRAL
INPUT RELAY

B080012

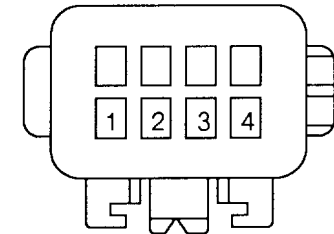

Wiring Face
AUXILIARY FUSE

B050010.00

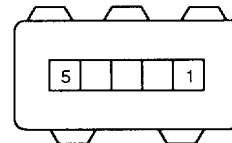

Mating Face
AIR FLOW METER

B260002.01

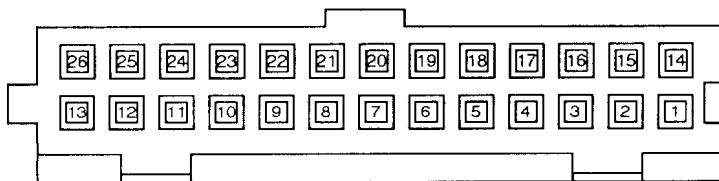

Mating Face
ACTIVE CHECK CONTROL

B030015.03

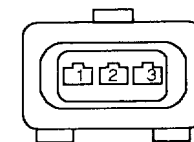

Wiring Face
BAROMETRIC PRESSURE
SENSOR

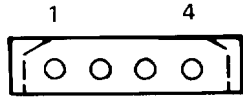

Wiring Face
CHIME MODULE (C1)

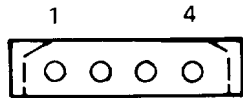

Wiring Face
BLOWER RESISTORS

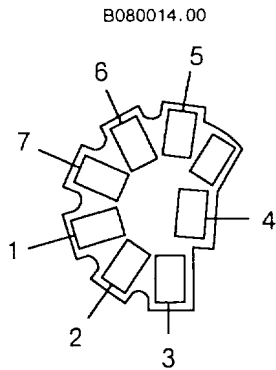

Wiring Face
BLOWER SPEED CONTROL

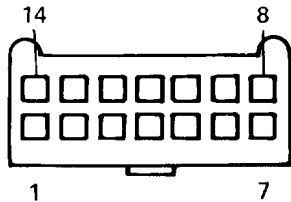

Wiring Face
CENTRAL LOCKING CONTROL UNIT

B260002.03

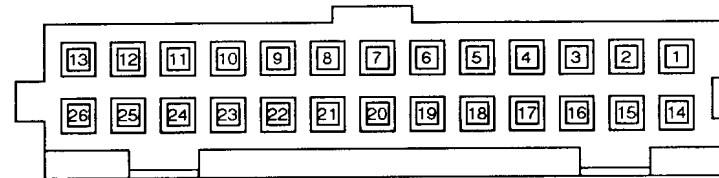

Wiring Face
CRUISE CONTROL UNIT

B040013

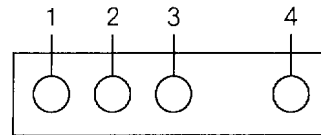

Wiring Face
CHIME MODULE (C2)

B030015.05

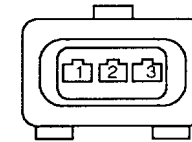

Mating Face
CYLINDER IDENTIFICATION SENSOR

B080013.00

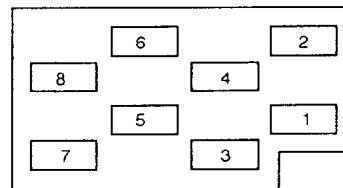

Wiring Face
CONTROL SWITCHES

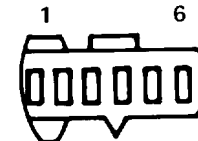

Wiring Face
DOOR LOCK MOTOR

B030019.00

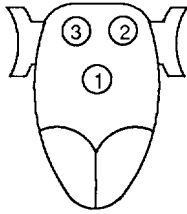

Wiring Face

DUAL TEMPERATURE SWITCH

B060024

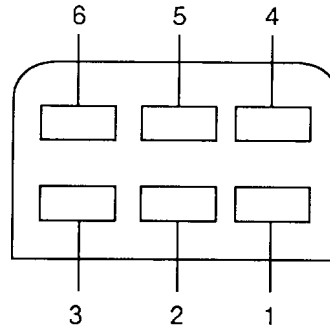

Wiring Face

EVAPORATOR TEMPERATURE
REGULATOR

B090001.17

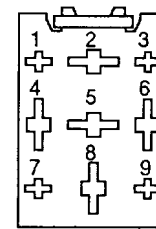

Mating Face

FRESH/RECIRCULATING AIR RELAY

B030015.04

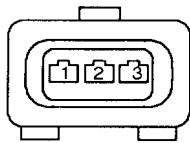

Wiring Face

ENGINE SPEED SENSOR

49A

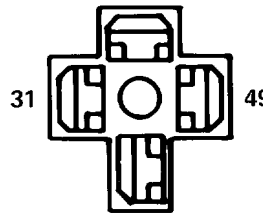

Wiring Face
FLASHER

B030017.00

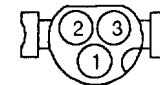

Wiring Face

FRONT TURN/PARK LIGHT

LATE PRODUCTION

for 325i/325is, 325ix

B090001.04

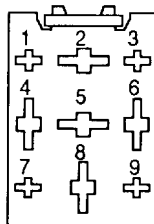

Mating Face

EVAPORATIVE
PURGE VALVE RELAY

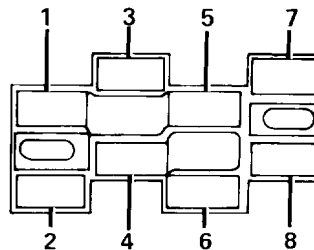

Wiring Face

FOG LIGHT SWITCH

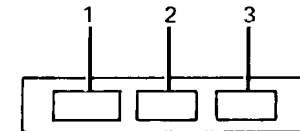

Wiring Face

FRONT TURN/PARK LIGHT

All 325ic, M3

EARLY PRODUCTION

for 325i/325is, 325ix

B030020.00

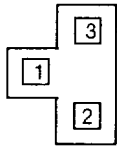

Wiring Face
INSTRUMENT CLUSTER (C6)

B090001.06

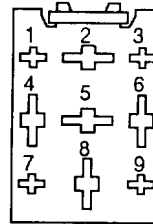

Mating Face
MAIN RELAY

2 6

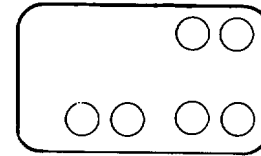

Mating Face
MIRROR CONTROL SWITCH

B090001.16

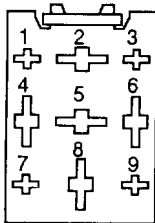

Mating Face
INTERIOR LIGHT TIMER CONTROL

B550001.02

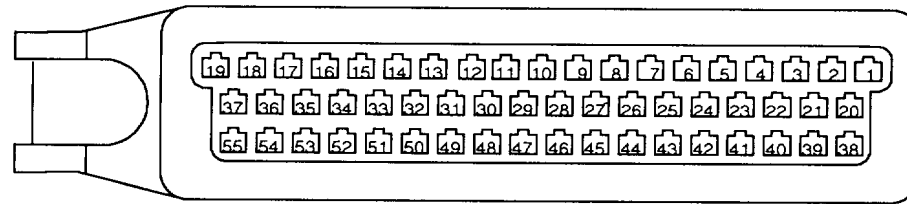

Mating Face
MOTRONIC CONTROL UNIT
ALL EXCEPT M3

B120006.00

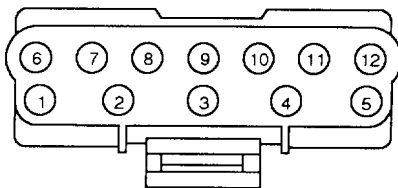

Wiring face
LIGHT SWITCH

B350002

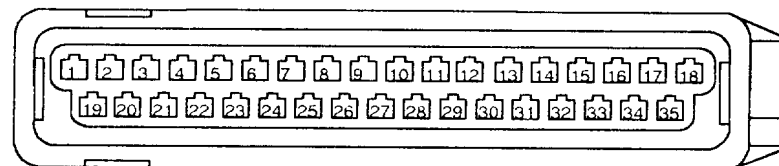

Mating Face
MOTRONIC CONTROL UNIT
(M3)

8500-6 CONNECTOR VIEWS

B030015.06

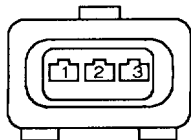

Wiring Face
OIL LEVEL SENSOR

B060027

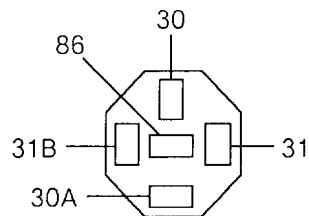

Wiring Face
OVER VOLTAGE PROTECTION RELAY

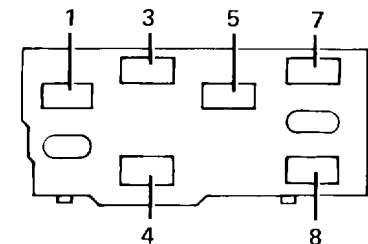

Wiring Face
POWER WINDOW SWITCHES

B260002.00

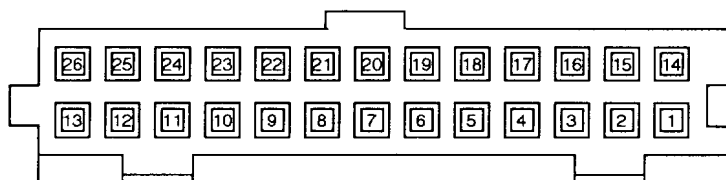

Mating Face
ON - BOARD COMPUTER MODULE

B090001.05

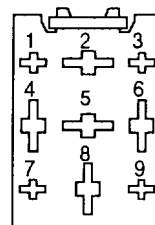

Mating Face
OXYGEN SENSOR HEATER RELAY

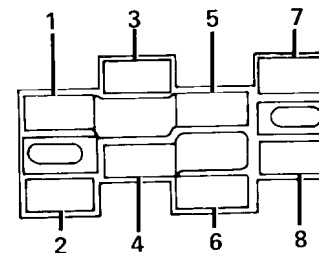

Wiring Face
REAR DEFOGGER SWITCH

B040012.02

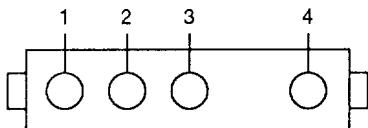

Wiring Face
ON - BOARD COMPUTER RELAY BOX (C2)

B040012.01

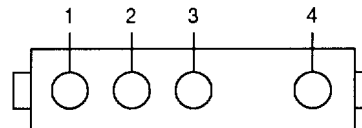

Wiring Face
POWER MIRRORS

B060027.00

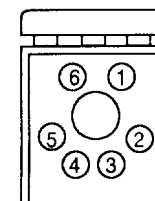

Wiring Face
REAR LIGHT ASSEMBLY

B060033.00

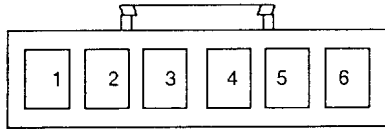

Wiring Face

REAR LIGHT ASSEMBLY

B0400002.03

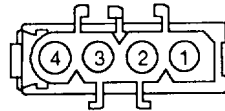

Mating Face

REAR WINDOW
BLOWER

B090001.08

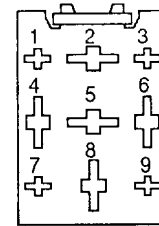

Mating Face

START RELAY

B080015.01

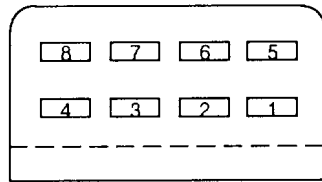

Wiring Face

REAR LIGHTS CHECK RELAY (C1)

B090001.14

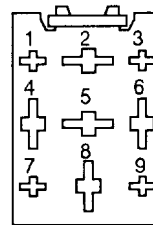

Mating Face

REAR WINDOW BLOWER RELAY



Wiring Face

SUNROOF MOTOR (CI)

B060028.01

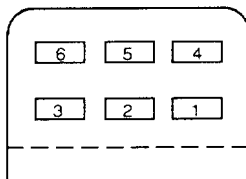

Wiring Face

REAR LIGHTS CHECK RELAY (C2)

B090001.05

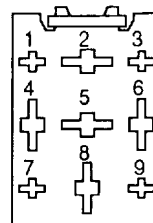

Mating Face

SEATBELT WARNING TIMER

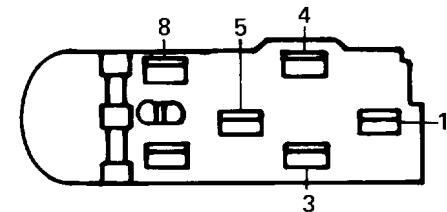

Wiring Face

SUNROOF SWITCH

B030015.07

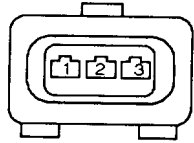

Wiring Face
THROTTLE SWITCH

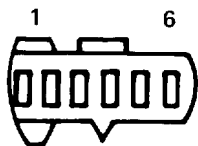

Wiring Face
TRUNK LID LOCK MOTOR

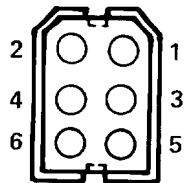

Wiring Face
WIPER MOTOR

B200002.00

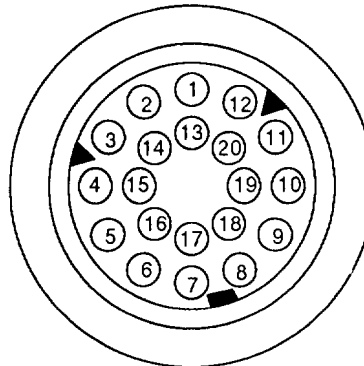

Wiring Face
C101

B300001.00

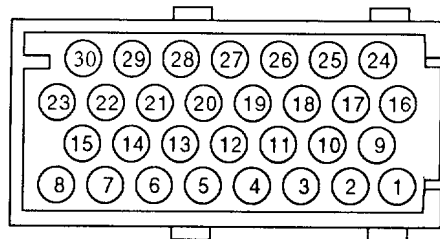

Wiring Face
C103

B030004.02



Mating Face
C110
C113



Wiring Face
C114

B040002.00

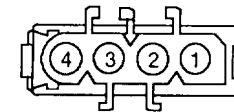

Wiring Face
C107
C131
C136

B040006.01

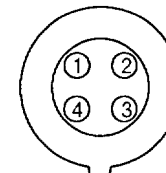

Wiring Face
C140

B030015.06

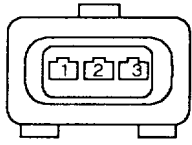

Wiring Face
C152, C153, C154

B070002.00

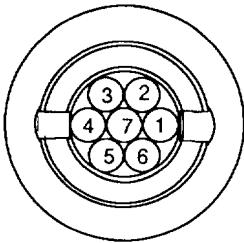

Wiring Face
C191

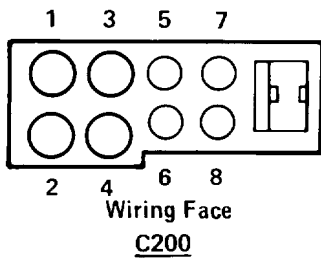

Wiring Face
C200

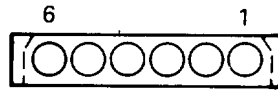

Wiring Face
C201

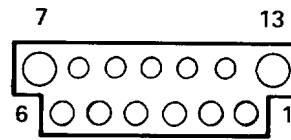

Wiring Face
C202

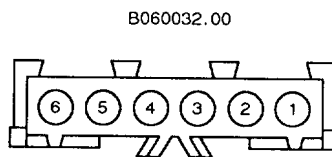

Wiring Face
C203

B120004.00

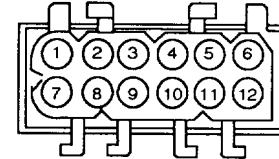

Wiring Face
C204

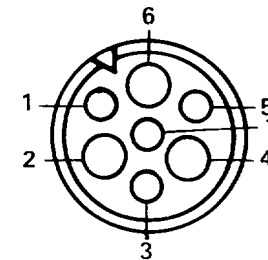

Wiring Face
C209

B070004.00

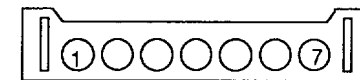

Wiring Face
C210

8500-10 CONNECTOR VIEWS

B070002.00

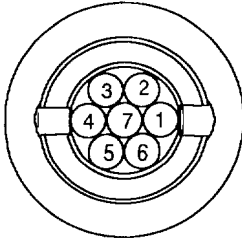

Wiring Face

C191

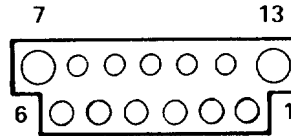

Wiring Face

C202

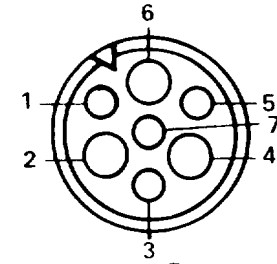

Wiring Face

C209

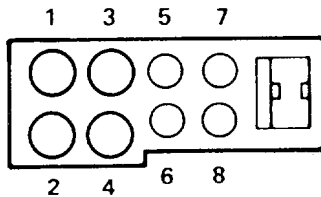

Wiring Face

C200

B060032.00

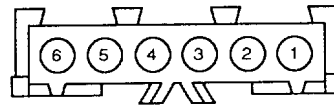

Wiring Face

C203

B070004.00

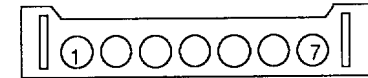

Wiring Face

C210

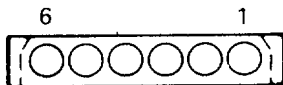

Wiring Face

C201

B120004.00

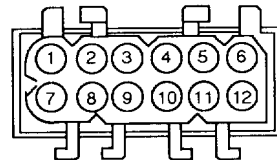

Wiring Face

C204

B060025

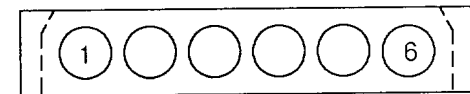

Wiring Face

C240

B060025

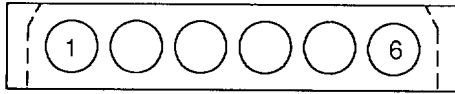

Wiring Face

C240

B060003.03

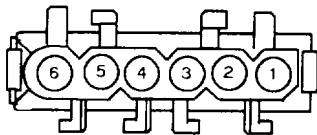

Mating Face

C242

B080002.00

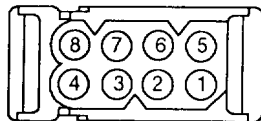

Mating Face

C243

1 2 3

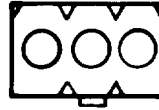

Wiring Face

C303

C304

6

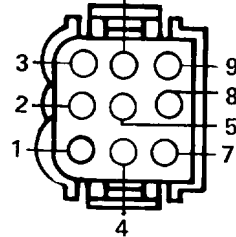

Wiring Face

C306

B050011.00

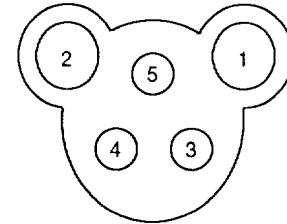

Wiring Face

C413

1 2 3 4



Wiring Face

C421

C422

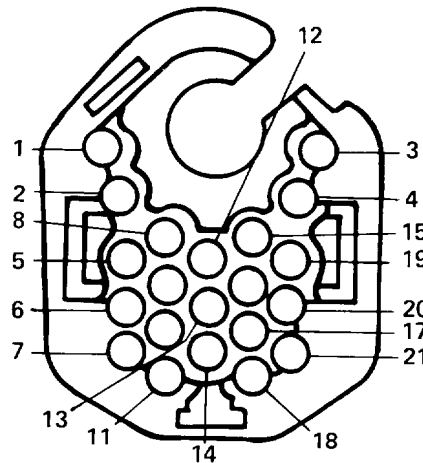

Wiring Face

C404

C405

3

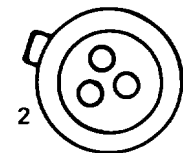

Wiring Face

C503

9000-0 COMPONENT LOCATION CHART

COMPONENTS

		Page-Figure
A/C In-Line Fuse	LH rear side of evaporator housing	7000- 7-3
ABS Clutch Switch	Behind LH side of dash, above clutch pedal	7000- 6-4
ABS Electronic Control Unit	Behind LH side of dash, above hood release	7000- 5-5
ABS Hydraulic Unit	LH front corner of engine compartment	7000- 0-6
ABS Neutral Input Relay	Behind LH side of dash, on accessory connector bracket	
Active Check Control Unit	Above rear view mirror	7000- 7-6
Air Flow Meter	LH front of engine compartment, behind air cleaner	7000- 0-5
Alternator	Lower LH front of engine	7000- 1-4
Auto-Charging Flashlight	Inside LH side of glove box	7000- 8-3
Automatic Transmission Range Switch	At base of gear shift lever	7000- 8-2
Auxiliary Fan	In front of radiator	7000- 1-6
Auxiliary Fan Normal Speed Blower Resistor	In front of radiator, RH side of auxiliary fan	7000- 1-6
Auxiliary Fuse	LH rear of engine compartment, above brake fluid reservoir	7000- 0-1
Back up Light Switch	Top RH side of transmission	7000- 3-5
Battery	In RH rear corner of trunk	7000-10-2
Battery Junction Block	RH rear of engine compartment, on RH bulkhead	7000- 3-3
Blower Motor	Inside fresh air intake cowl	7000- 0-4
Blower Resistors	Inside fresh air intake cowl, inside blower motor housing	
Brake Fluid Level Switch	LH side of engine compartment, on brake fluid reservoir	7000- 0-2
Brake Switch	Behind LH side of dash, on brake pedal support	7000- 6-5
Brake Wear Sensors	On LH front and RH rear brake calipers	7000- 4-3
Central Locking Control Unit	Inside LH kick panel, below LH front speaker	7000- 5-4
Chime Module	Mounted on LH dash hush panel	7000- 5-5
Clutch Switch	Behind LH side of dash, on clutch pedal support	7000- 6-4
Combination Switch	Upper LH side of steering column	7000- 6-2
Compressor Clutch	Lower RH front of engine, on A/C compressor	7000- 2-3
Compressor Clutch Diode	Lower RH front of engine, on A/C compressor	7000- 2-3
Coolant Level Switch	In front of LH front wheel well, in coolant reservoir	7000- 1-2
Coolant Temperature Sender	Top front of engine, top of thermostat housing	7000- 3-1
Coolant Temperature Sensor	Top front of engine, top of thermostat housing	7000- 3-1
Cruise Control Actuator	LH front of engine compartment	7000- 1-2
Cruise Control Unit	Behind RH side of dash, above glove box	7000- 8-4
Cylinder Identification Sensor	Top RH front of engine, near distributor	7000- 2-6
Deceleration Sensor	Behind LH front shock tower	7000- 0-1
Diagnostic Connector	Top LH front of engine	7000- 1-1
Door Lock Motors	Rear part of each door	7000- 4-6

COMPONENTS	Page-Figure
Driver's Exterior Door Handle	
Switch	In top rear of LH front door 7000- 5-2
Dual Temperature Switch	Top RH side of radiator 7000- 2-2
Engine Speed Sensor	Lower RH front of engine 7000- 2-4
Evaporative Purge Valve	Below LH side of throttle body 7000- 1-5
Evaporator Temperature	
Regulator	On LH side of evaporator housing 7000- 7-4
Evaporator Temperature Sensor	On LH side of evaporator housing 7000- 7-4
Filter Capacitor	Lower LH front of engine, on alternator 7000- 1-4
Flasher	Upper part of steering column 7000- 6-2
Fresh/Recirculating Air Flap Door	
Motors	Behind A/C face plate, on either side of evaporator housing 7000- 7-1
Fresh/Recirculating Air Relays	Behind A/C face plate 7000- 7-2
Fuel Injectors	Below intake manifold, at each cylinder 7000- 3-1
Fuel Pump Relay	Front of LH front shock tower, on bracket 7000- 0-5
Fuel Tank Sender	Below RH side of rear seat, top of fuel tank 7000- 9-5
Fusible Link A	RH rear corner of trunk, near battery 7000-10-2
Gas Filler Lock Motor	RH side of trunk, behind RH wheel well 7000-10-2
Glove Box Light Switch	Behind RH side of dash, above glove box 7000- 8-4
Hazard Switch	In center of dash, above digital radio 7000- 7-5
High Pressure Cut-Out Switch	On receiver dryer, behind RH headlight 7000- 2-5
Horn Brush/Slip Ring	In upper part of steering column 7000- 6-2
Horns	Near fog lights, behind splash guard 7000- 2-1
Hot Water Cut-Off Switch	Behind center of dash, near rotary temperature control 7000- 7-2
Idle Speed Actuator	Top LH side of engine 7000- 1-1
Ignition Coil	On RH front wheel well, forward of shock tower 7000- 2-5
Ignition Key Switch	Part of ignition switch, in upper part of steering column
Ignition Switch	Top RH side of steering column 7000- 6-2
Interior Light Timer Control	Inside LH kick panel, below LH front speaker 7000- 5-4
Left Tank Fuel Sender	Below LH side of rear seat 7000- 9-4
Low Pressure Cut-Out Switch	On receiver dryer, behind RH headlight 7000- 2-5
Main Fuel Pump	Below RH side of rear seat, in fuel tank 7000- 9-5
Main Relay	Front of LH front shock tower, on bracket 7000- 0-5
Motronic Control Unit	Behind RH side of dash, above glove box 7000- 8-4
Multi-Function Clock	In center of dash, RH side of digital radio 7000- 7-5
Oil Level Sensor	Bottom of oil pan 7000- 3-6
Oil Pressure Switch	Lower RH front of engine, below oil filter 7000- 3-4
Outside Temperature Sensor	Inside air intake, near LH fog light 7000- 4-1

9000-2 COMPONENT LOCATION CHART

COMPONENTS		Page-Figure
Over Voltage Protection Relay . .	Behind LH side of dash, near ABS Electronic Control Unit	7000- 5-6
Oxygen Sensor	Lower RH rear of engine compartment, on exhaust manifold	7000- 3-2
Oxygen Sensor Heater Relay . . .	Front of LH front shock tower, on bracket	7000- 0-5
Park Brake Switch	Rear of center console, at base of parking brake . . .	7000- 9-2
Power Antenna	LH side of trunk, behind LH rear wheel well	7000- 9-6
Power Distribution Box	LH rear corner of engine compartment	7000- 0-1
Power Window Circuit Breaker . .	On center console, near gear shift lever	7000- 8-1
Pulse Wheels	On respective wheels, in brake housing	
Rear Lights Check Relay	LH side of trunk, above LH wheel well	7000- 9-6
RH Front Door Micro-Switch . . .	In top rear of RH front door	7000- 5-3
Safety Switch	On center console, near gear shift lever	7000- 8-2
Seatbelt Switch	In driver's seatbelt buckle assembly	
Seatbelt Warning Timer	Behind LH side of dash, on electrical bracket	7000- 6-6
Speed Detectors	On wheels, in brake housing	7000- 4-2
Speedometer Sender	On rear of differential	7000-10-4
Start Relay	Behind LH side of dash, on accessory connector bracket	7000- 6-1
Starter	Lower LH rear of engine	7000- 1-3
Throttle Switch	Below LH side of throttle body	7000- 1-5
Trunk Lid Lock Motor	On trunk lock center support	7000-10-1
Trunk Light Switch	Top center of trunk lid	7000-10-3
Unlock Inhibit Switch	Top rear of LH front door	7000- 5-3
Washer Fluid Level Switch	Behind RH front shock tower in washer fluid reservoir	7000- 3-3
Washer Pump	Behind RH front shock tower, on washer fluid reservoir	7000- 3-3
Water Shut-Off Solenoid	LH side of evaporator housing	7000- 7-3
Window Motors	Forward part of each door	7000- 5-1
Wiper Motor	Inside LH side of fresh air intake cowl	7000- 0-4

CONNECTORS

		Page-Figure
C 101 (20 pins)	Next to power distribution box, mounted on engine dash	7000- 0-2
C 103 (29 pins)	Behind LH side of dash, on body electrical bracket	7000 6-3
C 104 (2 pins)	Under LH side of dash, near accessory connector	7000- 6-3
C 110	RH front of engine compartment	7000- 2-5
C 113 (3 pins)	Behind LH headlight	7000- 0-6
C 14 (8 pins)	LH rear corner of engine compartment, on power distribution box	7000- 0-3
C 115 (2 pins)	LH rear corner of engine compartment, on power distribution box	7000- 0-3
C 131 (1 pin)	Behind RH side of dash, above glove box	7000- 8-4
C 136 (4 pins)	Behind RH side of dash, above glove box	7000- 8-4
C 140 (4 pins)	RH rear of engine compartment, under tray	7000- 3-2
C 142 (1 pin)	Behind LH side of dash, near steering column	7000- 5-5
C 143 (1 pin)	Behind LH side of dash, near accessory connector	7000- 6-1
C 150 (2 pins)	Front of LH front wheel well	7000- 0-5
C 151 (2 pins)	Below RH front wheel well	7000- 2-5
C 190 (2 pins)	Below RH side of rear seat	7000- 9-5
C 191 (7 pins)	Lower LH side of engine	7000 1-3
C 200 (10 pins)	Behind LH side of dash, on steering column	7000- 6-6
C 201 (6 pins)	Behind LH side of dash, on steering column	7000- 6-6
C 202 (13 pins)	Behind LH side of dash, on steering column	7000- 6-6
C 204 (12 pins)	Behind LH side of dash, RH side of steering column	7000- 7-1
C 209 (7 pins)	Behind LH side of dash, near brake pedal support	7000- 6-3
C 210 (7 pins)	Behind LH side of dash, on steering column	7000- 6-6
C 215 (2 pins)	Behind center of dash, near digital radio	7000- 7-5
C 216 (2 pins)	Behind center of dash, on digital radio	7000- 7-5
C 217 (2 pins)	Behind center of dash, on digital radio	7000- 7-5
C 218 (2 pins)	Behind center of dash, on digital radio	7000- 7-5
C 219 (2 pins)	LH side of trunk, above LH rear wheel well	7000- 9-6
C 220 (2 pins)	Behind LH side of dash	
C 221 (2 pins)	Behind RH side of dash	
C 240 (6 pins)	Under LH side of dash, RH side of accessory connector	7000- 6-3
C 241 (1 pin)	Behind LH side of dash, above steering column	7000- 6-6
C 243 (8 pins)	Behind center of dash, near digital radio	7000- 7-5
C 244 (2 pins)	Behind center of dash, on digital radio	7000- 7-5
C 245 (2 pins)	Behind center of dash, on digital radio	
C 250 (2 pins)	Behind LH side of dash, base of steering column	
C 260 (2 pins)	Behind LH side of dash, near accessory connector	7000- 6-3
C 301 (2 pins)	Below center console, near gear shift lever	7000- 8-1

9000-4 COMPONENT LOCATION CHART

CONNECTORS

Page-Figure

C302 (25 pins) Accessory Connector	Behind LH side of dash, on body electrical bracket.	7000- 6-3
C303 (3 pins)	At base of RH "B" pillar	7000- 9-1
C304 (3 pins)	At base of LH "B" pillar	7000- 8-6
C305 (1 pin)	Behind LH side of dash, near accessory connector	
C306 (9 pins)	Below center console, near gear shift lever.	7000- 8-2
C352 (2 pins)	Behind LH side of rear seat.	7000- 9-3
C360 (2 pins)	Below RH side of rear seat	7000- 9-5
C401 (7 pins)	In LH "B" pillar	7000- 8-5
C402 (7 pins)	In RH "B" pillar	7000- 8-5
C403 (4 pins)	Behind LH side of dash	7000- 5-5
C404 (21 pins)	Above RH front door jamb switch	7000- 4-5
C405 (21 pins)	Above LH front door jamb switch	7000- 4-4
C421 (2 pins)	Below RH front seat assembly	
C422 (2 pins)	Below LH front seat assembly	
C503 (3 pins)	In lower rear of LH front door	7000- 4-6
C510 (1 pin)	Inside LH kick panel, above LH front speaker	7000- 5-4

GROUNDS

G100.	RH rear corner of trunk, behind battery	7000-10-2
G103.	Behind RH front shock tower	7000- 3-3
G104.	On inner fender, behind LH headlight.	7000- 1-2
G200.	Under LH side of dash, above brake pedal	7000- 6-5
G201.	Upper LH side of steering column	7000- 6-2
G300.	Behind LH side of rear seat.	7000- 9-3
G302.	LH side of trunk, on power antenna bracket	7000- 9-6
