

---

**1986**

---

**BMW 325**

---

**Electrical**

---

**Troubleshooting**

---

**Manual**

---

BMW of North America, Inc.  
Montvale, New Jersey

**1986  
BMW 325e  
Electrical  
Troubleshooting  
Manual**

**CONTENTS**

---

Index . . . . .	2
How To Use This Manual . . . . .	3
Symbols . . . . .	4
Wire Size Conversion Chart . . . . .	5
Systematic Troubleshooting . . . . .	6
Diagnostic Connector . . . . .	8500-1
Power Distribution Box . . . . .	0670-0
Fuse Data . . . . .	0670-1
Component Location Chart . . . . .	9000-0
Component Location Views . . . . .	7000-0
Splice Location Views . . . . .	8000-0

---

Index — Alphabetical Listing of Electrical Circuits (325)

	PAGE		PAGE		PAGE
Active Check Control . . . . .	6216-0	Heating		— Glove Box . . . . .	6100-1
Air Conditioning		— Air Delivery Control . . . . .	6421-0	— Hazard Switch . . . . .	6313-0
— Air Delivery Control . . . . .	6421-0	— Blower Controls . . . . .	6413-0	— Headlights . . . . .	6312-0
— Blower Controls . . . . .	6413-0	— Compressor Controls . . . . .	6452-0	— Instrument Cluster . . . . .	6300-1
— Compressor Controls . . . . .	6452-0	— Temperature Control . . . . .	6411-0	— Interior (2 Door) . . . . .	6330-0
— Temperature Control . . . . .	6411-0	Horns . . . . .	6100-0	— Interior (4 Door) . . . . .	6330-1
AntiLock Brake . . . . .	3450-0	Idle Speed Control . . . . .	1360-3	— License . . . . .	6320-0
Auto-Charging Flashlight . . . . .	6100-1	Ignition . . . . .	1360-4	— Map Reading Light . . . . .	6100-1
Auxiliary Fan . . . . .	6454-0	Ignition Key Warning . . . . .	6131-0	— Rear Side Marker . . . . .	6320-0
Auxiliary Fuse . . . . .	0670-2	Indicators		— Stop . . . . .	6325-0
Brake Warning System . . . . .	3435-0	— Active Check Control Alarm . . . . .	6216-2	— Tail . . . . .	6314-0
Central Locking		— “Brake Lights” Fault . . . . .	6216-1	— Trunk . . . . .	6320-0
— (2 Door) . . . . .	5126-0	— “Brake Lining” Wear . . . . .	3435-0	— Turn/Park . . . . .	6313-1
— (4 Door) . . . . .	5126-2	— “Brake Warning” . . . . .	3435-0	Light Switch Details . . . . .	6300-0
Charge System . . . . .	1230-0	— Charge . . . . .	6210-0	Multifunction Clock . . . . .	6581-2
Cigar Lighter . . . . .	6100-1	— “Coolant” Level Fault . . . . .	6216-2	On-Board Computer . . . . .	6581-0
Connectors		— “Engine Oil” Fault . . . . .	6216-2	Power Antenna . . . . .	6500-0
— Accessory . . . . .	8500-1	— Fasten Seatbelts . . . . .	6216-2	Power Distribution . . . . .	0670-3
— Diagnostic . . . . .	8500-0	— Fog Lights . . . . .	6312-0	Power Distribution Box . . . . .	0670-0
Cruise Control . . . . .	6571-0	— High Beam . . . . .	6210-0	Power Mirrors . . . . .	5116-0
Engine Control Block Diagram . . . . .	1250-0	— Inspection . . . . .	6210-1	Power Windows	
Fuel Delivery . . . . .	1360-0	— LH Turn . . . . .	6210-0	— (2 Door) . . . . .	5133-4
Fuel Economy Gauge . . . . .	6210-3	— “License Plate” Fault . . . . .	6216-1	— (4 Door) . . . . .	5133-0
Fuel Gauge . . . . .	6210-2	— “Low Beam” Fault . . . . .	6216-0	Radio . . . . .	6500-0
Fuse Details		— Low Fuel Warning . . . . .	6210-2	Rear Defogger . . . . .	6100-2
— Fuse 4 . . . . .	0670-9	— Oil Pressure Warning . . . . .	6210-2	Seatbelt Warning . . . . .	6131-0
— Fuse 5 . . . . .	0670-9	— Oil Service . . . . .	6210-1	Service Interval Indicator . . . . .	6210-1
— Fuse 6 . . . . .	0670-9	— “Park Brake” . . . . .	3435-0	Speedometer . . . . .	6210-0
— Fuse 8 . . . . .	0670-10	— “Rear Lights” Fault . . . . .	6216-1	Splice Location Views Index . . . . .	8000-0
— Fuse 9 . . . . .	0670-11	— RH Turn . . . . .	6210-0	Start	
— Fuse 10 . . . . .	0670-6	— “Washer Fluid” Fault . . . . .	6216-2	— Automatic . . . . .	1240-0
— Fuse 12 . . . . .	0670-10	Lights		— Manual . . . . .	1240-1
— Fuse 19 . . . . .	0670-10	— A/C Control Power . . . . .	6300-1	Sunroof . . . . .	5413-0
— Fuse 20 . . . . .	0670-7	— Ashtray . . . . .	6300-1	Tachometer . . . . .	6210-3
— Fuse 21 . . . . .	0670-8	— Backup . . . . .	6322-0	Temperature Gauge . . . . .	6210-2
— Fuse 27 . . . . .	0670-11	— Cigar Lighter . . . . .	6300-1	Warnings	
Gauges . . . . .	6210-2	— Fog . . . . .	6312-0	— Ignition Key/Seatbelt . . . . .	6131-0
Ground Distribution . . . . .	0670-12	— Front Side Marker . . . . .	6314-0	Wiper/Washer . . . . .	6160-0
		— Front Turn/Park . . . . .	6314-0		

The purpose of this manual is to show electrical schematics in a manner that makes electrical troubleshooting easier. Electrical components which work together are shown together on one schematic. The Wiper-Washer schematic, for example, shows all of the electrical components in one diagram. At the top of the page is the fuse (positive) that powers the circuit. The flow of current is shown through all wires, connectors, switches, and motors to ground (negative) at the bottom of the page.

Within the schematic, all switches and sensors are shown "at rest," as though the Ignition Switch were off. For identification, component names are underlined and placed next to or above each component. Notes are included, describing how switches and other components work.

The power distribution schematic shows the current feed through all the connections from the Battery and Alternator to each fuse and the Ignition and Light Switches. If the Power Distribution schematic is combined with any other circuit schematic, a complete picture is made of how that circuit works. The Ground Distribution schematics show how several circuits are connected to common grounds.

All wiring between components is shown exactly as it exists in the vehicle; however, the wiring is not drawn to scale. To aid in understanding electrical operation, wiring inside complicated components has been simplified. The "Solid State" label designates electronic components.

WIRE SIZE CONVERSION CHART	
METRIC (CROSSSECTIONAL AREA IN MM <sup>2</sup> )	AWG (AMERICAN WIRE GAUGE)
.5	20
.75	18
1	16
1.5	14
2	14
2.5	12
4	10
6	8
8	8
16	4
20	4
25	2
32	2

WIRE INSULATION	
ABBREVIATIONS	COLOR
BK	BLACK
BR	BROWN
RD	RED
YL	YELLOW
GN	GREEN
BU	BLUE
VI	VIOLET
GY	GRAY
WT	WHITE
PK	PINK

# 4 SYMBOLS



ENTIRE COMPONENT SHOWN



PART OF A COMPONENT SHOWN

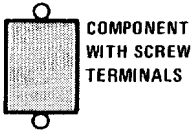

COMPONENT WITH SCREW TERMINALS



SOLID STATE (INCLUDES ONLY ELECTRONIC PARTS)

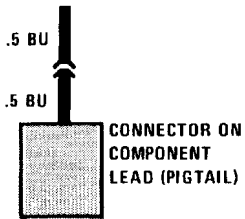

CONNECTOR ON COMPONENT LEAD (PIGTAIL)

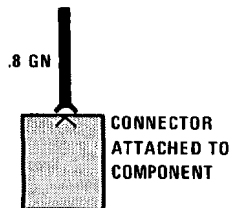

CONNECTOR ATTACHED TO COMPONENT

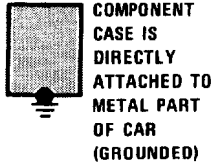

COMPONENT CASE IS DIRECTLY ATTACHED TO METAL PART OF CAR (GROUNDED)

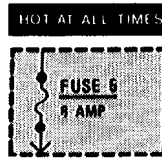

INDICATES THAT FUSE 5 IS ALWAYS SUPPLIED WITH POWER

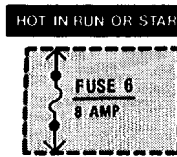

INDICATES THAT FUSE 6 IS SUPPLIED WITH POWER WITH THE IGNITION SWITCH IN THE RUN OR START POSITIONS

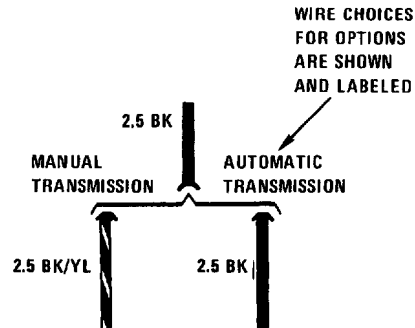

WIRE CHOICES FOR OPTIONS ARE SHOWN AND LABELED

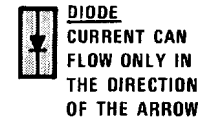
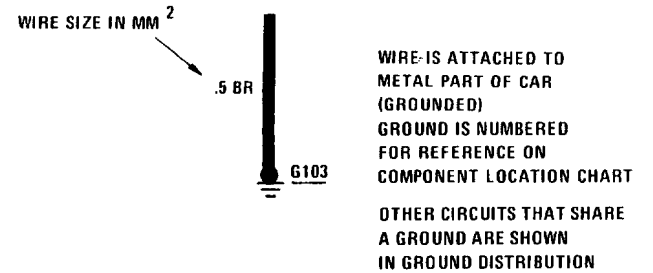
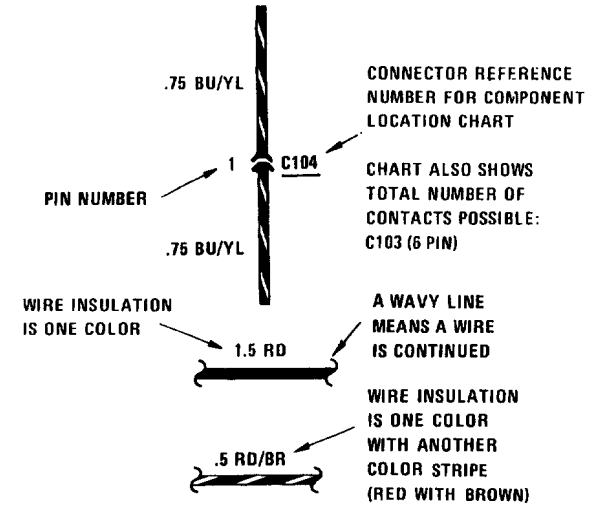

DIODE CURRENT CAN FLOW ONLY IN THE DIRECTION OF THE ARROW

CIRCUIT REFERENCE - A WIRE WHICH CONNECTS TO ANOTHER CIRCUIT

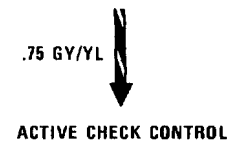

ACTIVE CHECK CONTROL

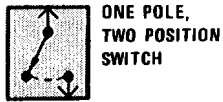

**ONE POLE,  
TWO POSITION  
SWITCH**

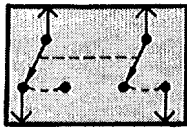

**SWITCHES THAT  
MOVE TOGETHER**  
  
DASHED LINE SHOWS  
A MECHANICAL  
CONNECTION  
BETWEEN SWITCHES

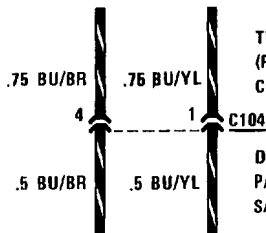

**TWO CONNECTIONS  
(PINS) IN THE SAME  
CONNECTOR**

**DASHED LINE SHOWS  
PARTS OF THE  
SAME CONNECTOR**



**RELAY SHOWN  
WITH NO  
CURRENT  
FLOWING  
THROUGH  
COIL**

**WHEN COIL IS  
ENERGIZED, SWITCH  
IS PULLED CLOSED**



**RELAY SHOWN  
WITH RESISTOR  
ACROSS COIL**

**RESISTOR ACROSS COIL  
IS FOR NOISE  
SUPPRESSION**

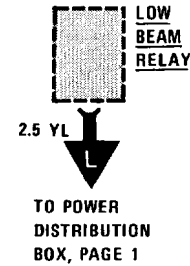
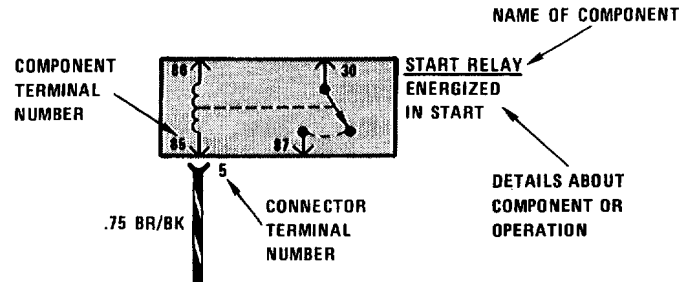

**CURRENT PATH  
IS CONTINUED  
AS LABELED.  
THE ARROW SHOWS  
DIRECTION OF CURRENT  
FLOW AND IS REPEATED  
WHERE CURRENT  
PATH CONTINUES.**

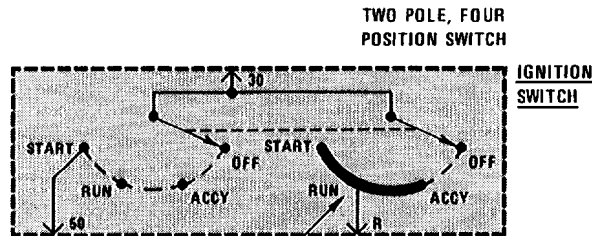

**"R" IS ENERGIZED  
IN ACCY, RUN OR START**

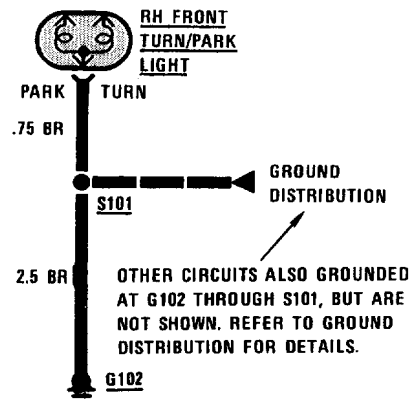
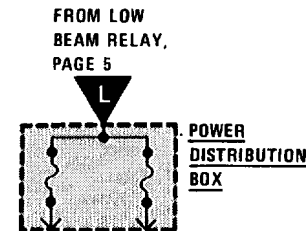

**LIGHT  
EMITTING  
DIODE**

## 6 SYSTEMATIC TROUBLESHOOTING

### TROUBLESHOOTING PROCEDURE

#### 1. Verify the Problem

Operate the problem circuit to check the accuracy of the complaint. Note the symptoms of the inoperative circuit.

#### 2. Analyze the Problem

Refer to the schematic of the problem circuit in the ETM. Determine how the circuit is supposed to work by tracing the current path(s) from the power feed through the circuit components to ground. Then based on the symptoms you noted in step 1 and your understanding of circuit operation, identify one or more possible causes of the problem.

#### 3. Isolate the Problem

Make circuit tests to prove or disprove the preliminary diagnosis made in step 2. Keep in mind that a logical simple procedure is the key to efficient troubleshooting. Test for the most likely cause of failure first. Try to make tests at points which are easily accessible.

#### 4. Repair the Problem

Once the specific problem is identified, make the repair using the proper tools and safe procedures.

#### 5. Check the Problem

Operate the circuit to check for satisfactory circuit operation. Good repair practice calls for rechecking all circuits you have worked on.

### TROUBLESHOOTING TOOLS

Isolating the problem (Step 3 of TROUBLESHOOTING PROCEDURES) requires the use of a **voltmeter** and/or **ohmmeter**. A voltmeter measures voltage at selected points in a circuit. An ohmmeter measures a circuit's resistance to current flow. It has an internal battery that provides current to the circuit under test. Disconnect the car battery when using an ohmmeter because the battery voltage will cause the ohmmeter to give false readings. Also, do not use an ohmmeter on solid-state components. The voltage that the ohmmeter applies to the circuit could damage these components.

### TROUBLESHOOTING TESTS

#### Voltage Test

This test measures voltage in a circuit. By taking measurements at several points (terminals or connectors) along the circuit, you can isolate the problem.

To take a voltage measurement, connect the negative lead of the voltmeter to the battery's negative terminal or other known good ground. Then connect the positive lead of the voltmeter to the point you want to test. The voltmeter will measure the voltage present at that point in the circuit.

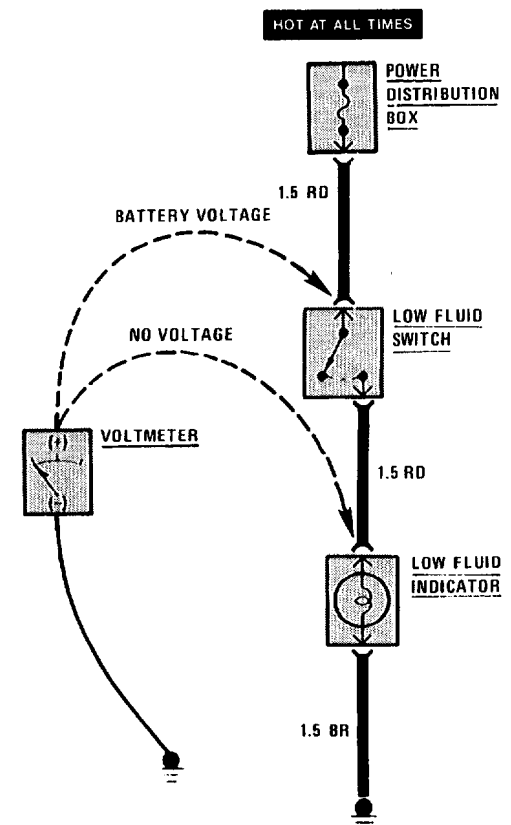

Voltage Test

Voltage Drop Test

Wires, connectors, and switches are designed to conduct current with a minimum loss of voltage. A voltage drop of more than one volt indicates a problem.

To test for voltage drop, connect the voltmeter leads to connectors at either end of the circuit's suspected problem area. The positive lead should be connected to the connector closest to the power source. The voltmeter will show the voltage drop between these two points.

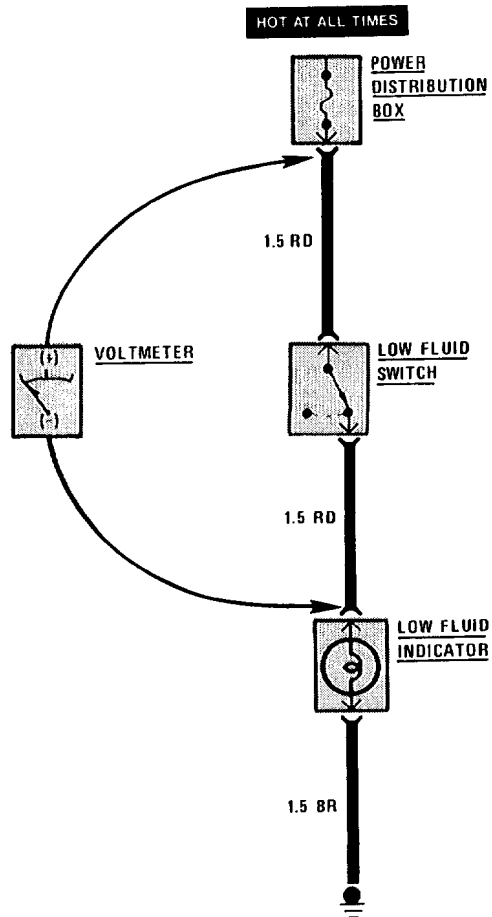

Voltage Drop Test

Continuity Test

To perform a continuity test, first disconnect the car battery. Then adjust the ohmmeter to read zero while holding the leads together. Connect the ohmmeter leads to connector or terminals at either end of the circuit's suspected problem area. The ohmmeter will show the resistance across that part of the circuit.

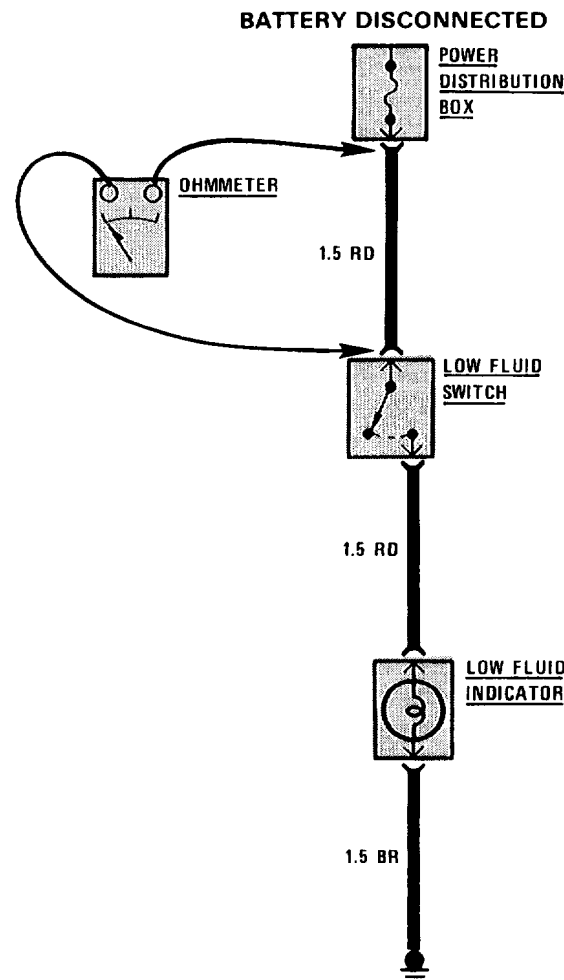

Continuity Test

Short Test Using Voltmeter

Remove the blown fuse and disconnect the load. Connect the voltmeter leads to the fuse terminals. The positive lead should be connected to the terminal closest to the power source.

Starting near the POWER DISTRIBUTION BOX, move the wire harness back and forth and watch the voltmeter reading. If the voltmeter registers a reading, there is a short to ground in the wiring. Somewhere in the area of the harness being moved, the wire insulation is worn away and the circuit is grounding.

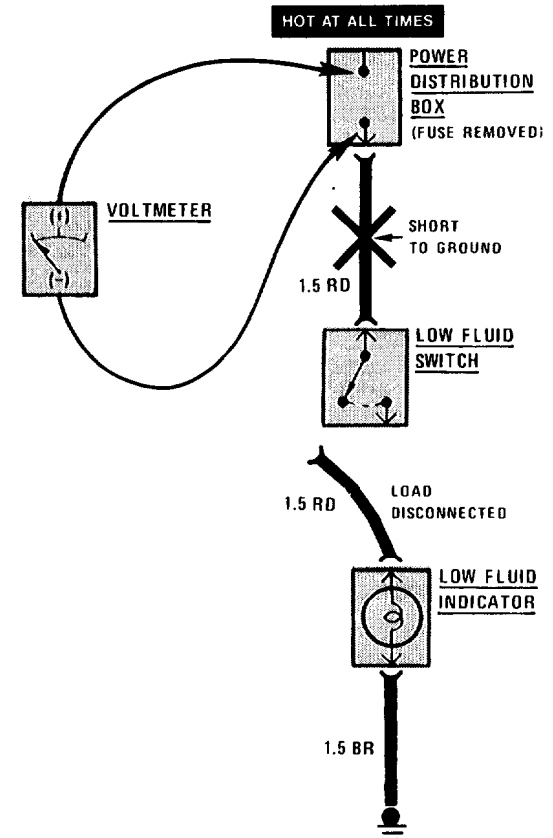

Short Test Using Voltmeter



## 8 SYSTEMATIC TROUBLESHOOTING

### Short Test Using Ohmmeter

Disconnect the battery. Adjust the ohmmeter to read zero while holding the leads together. Remove the blown fuse and disconnect the load. Connect one lead of the ohmmeter to the fuse terminal that is closest to the load. Connect the other lead to a known good ground.

Starting near the POWER DISTRIBUTION BOX, move the wire harness back and forth and watch the ohmmeter reading. Low or no resistance indicates a short to ground in the wiring. Infinitely high resistance indicates no short.

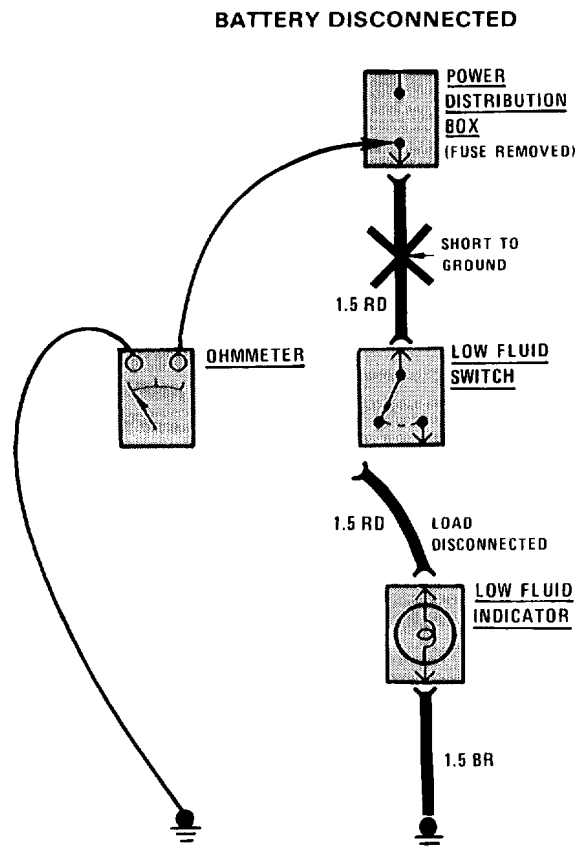

Short Test Using Ohmmeter

# 0670-0 POWER DISTRIBUTION

## POWER DISTRIBUTION BOX

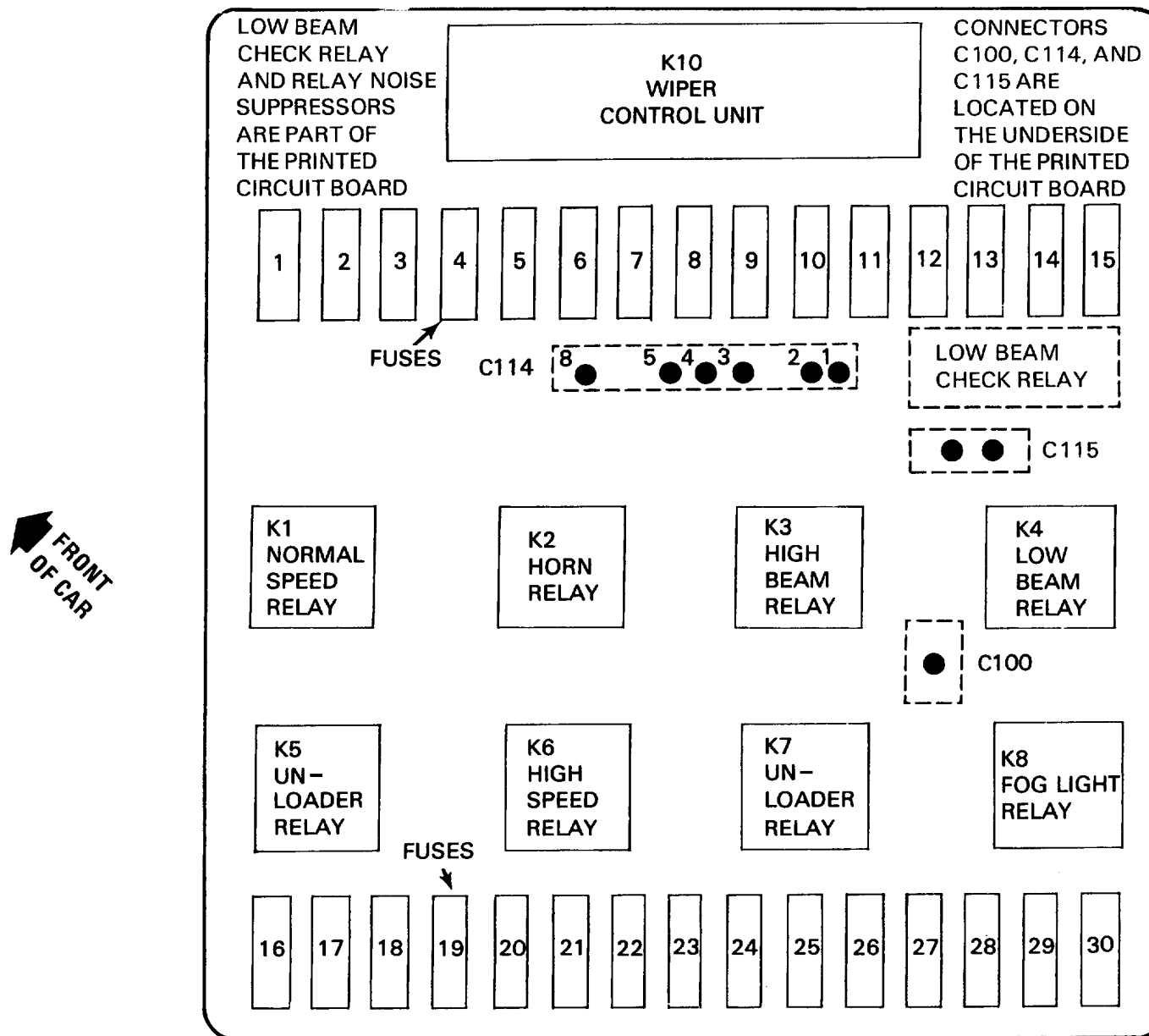

FUSE DATA CHART

FUSE NO.	SIZE/ COLOR	CIRCUIT NAME
1	7.5A (BR)	Headlights (also fuses 2, 13, 14).
2	7.5A (BR)	Headlights (also fuses 1, 13, 14).
3	15A (LT BU)	Auxiliary Fan (also fuses 18, 19).
4	15A (LT BU)	Lights: Turn/Hazard Warning (also fuse 24); Active Check Control (also fuses 6, 10, 21, 22, 23).
5	30A (LT GN)	Wiper/Washer.
6	7.5A (BR)	Stop Lights/Cruise Control (also fuse 10); Active Check Control (also fuses 4, 10, 21, 22, 23);
7	15A (LT BU)	Horn.
8	30A (LT GN)	Rear Defogger (also fuse 23).
9	15A (LT BU)	Idle Speed Control (also fuse 10).
10	7.5A (BR)	Seatbelt Warning (also fuse 21); Service Interval Indicator (also fuse 21); Tachometer/Fuel Economy Gauges (also fuse 21); Gauges/Indicators; Brake Warning System; Back Up Lights; On-Board Computer (also fuses 12, 21, 27); Start; Idle Speed Control (also fuse 9); Active Check Control (also fuse 21); Stop Lights/Cruise Control (also fuse 6).
11	15A (LT BU)	Fuel Delivery.
12	7.5A (BR)	Radio (also fuse 21); Speedometer/Indicators (also fuse 8); On-Board Computer (also fuse 10, 21, 27).
13	7.5A (BR)	Headlights (also fuses 1, 2, 14).
14	7.5A (BR)	Headlights (also fuses 1, 2, 13).
15		Not Used.
16		Not Used.
17	30A (LT BU)	Sunroof & Power Windows
18	30A (LT GN)	Auxiliary Fan (also fuses 3, 19).
19	7.5A (BR)	Auxiliary Fan (also fuses 3, 18); Interior Lights (also fuses 21, 27); Power Mirrors.

FUSE NO.	SIZE/ COLOR	CIRCUIT NAME
20	30A (LT GN)	Heater/Air Conditioning (also fuse 28).
21	7.5A (BR)	Auto-Charging Flashlight; Glove Box Light; Ignition Key Warning/Seatbelt Warning (also fuse 10); Interior Lights (also fuses 14, 22, 27); Radio (also fuse 12); Trunk Light; Active Check Control (also fuses 4, 6, 10, 22, 23); Service Interval Indicator (also fuse 10); On-Board Computer (also fuses 10, 12, 27); Fuel Delivery; Tachometer/Fuel Economy Gauge (also fuse 10).
22	7.5A (BR)	Active Check Control (also fuses 4, 6, 10, 21, 23); Lights: Front Park/Tail (also fuse 23); Lights: Front Side Marker (also fuse 23).
23	7.5A (BR)	Lights: Dash Lights: Front Park/Tail (also fuse 22); Lights: Front Side Marker (also fuse 22); Lights: Rear Marker/License; Active Check Control (also fuses 4, 6, 10, 21 & 22); Rear Defogger (also fuse 8).
24	15A (LT BU)	Lights: Turn/Hazard Warning (also fuse 4).
25		Not Used.
26		Not Used.
27	30A (LT GN)	Interior Lights (also fuses 19, 21); Central Locking; On-Board Computer (also fuses 10, 12, 21).
28	30A (LT GN)	Cigar Lighter; Power Antenna.
29	7.5A (BR)	Fog Lights (also fuse 30).
30	7.5A (BR)	Fog Lights (also fuse 29).



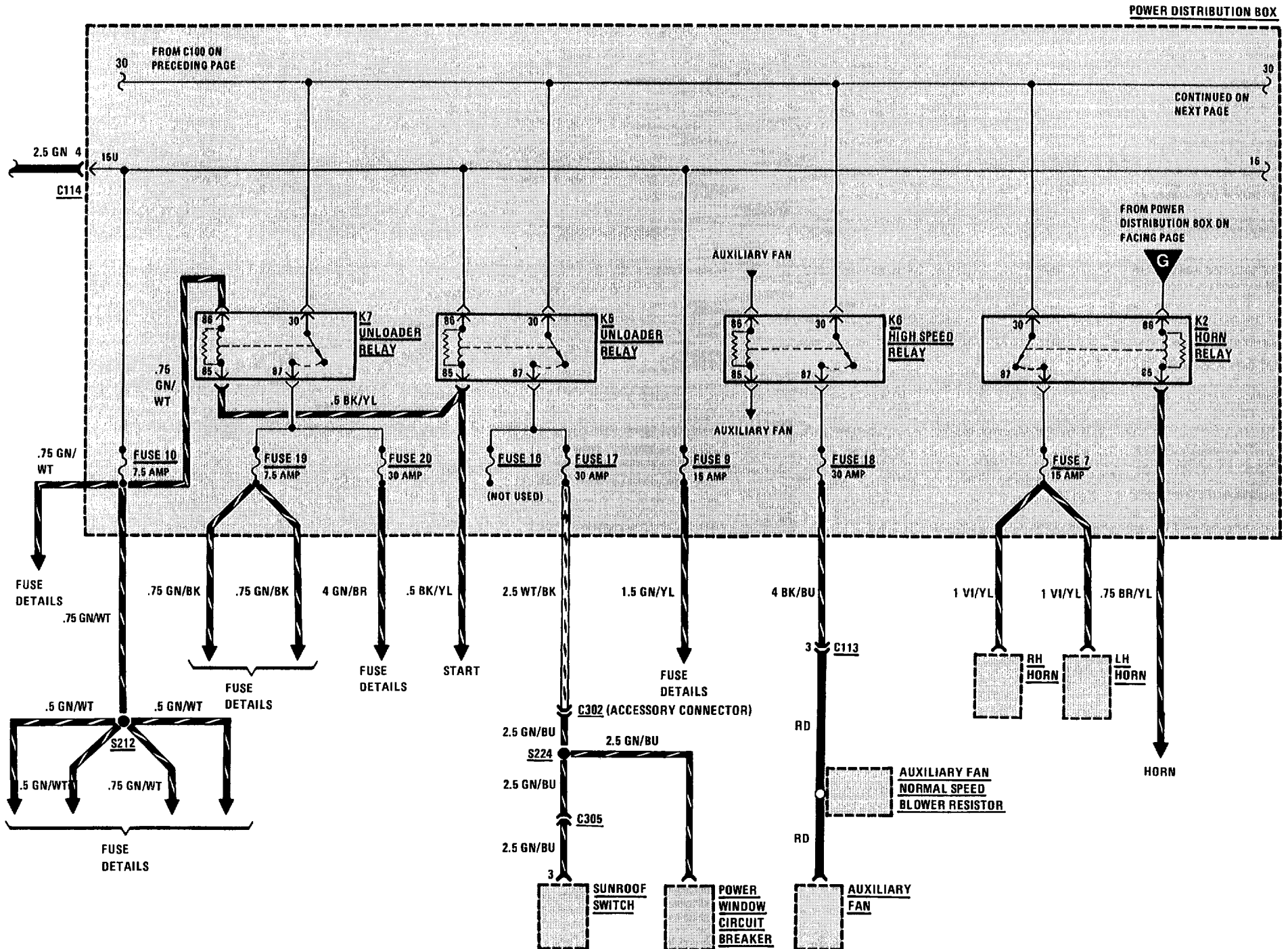

# 0670-4 POWER DISTRIBUTION

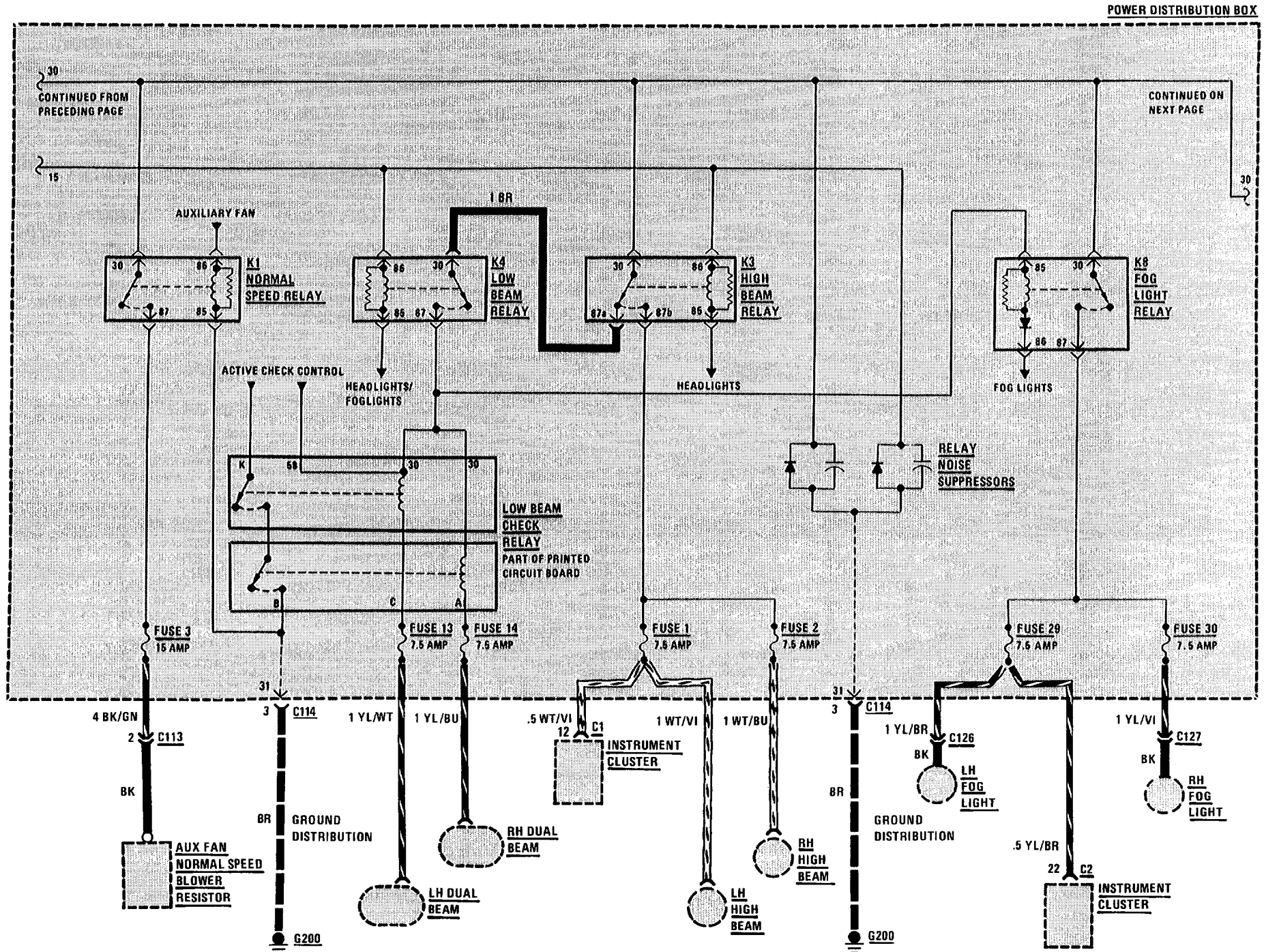

POWER DISTRIBUTION BOX

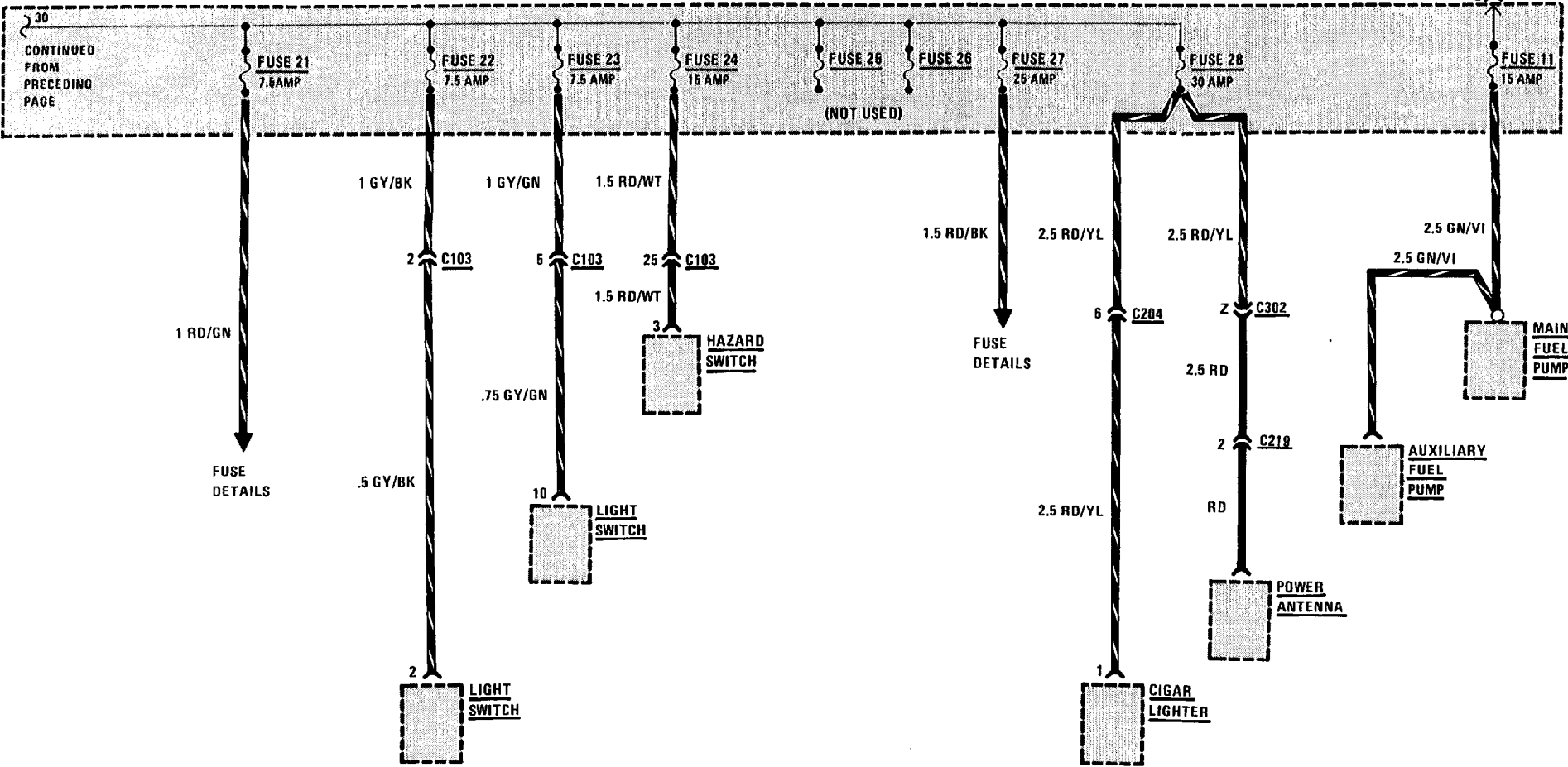

FUSE DETAILS: FUSE 10

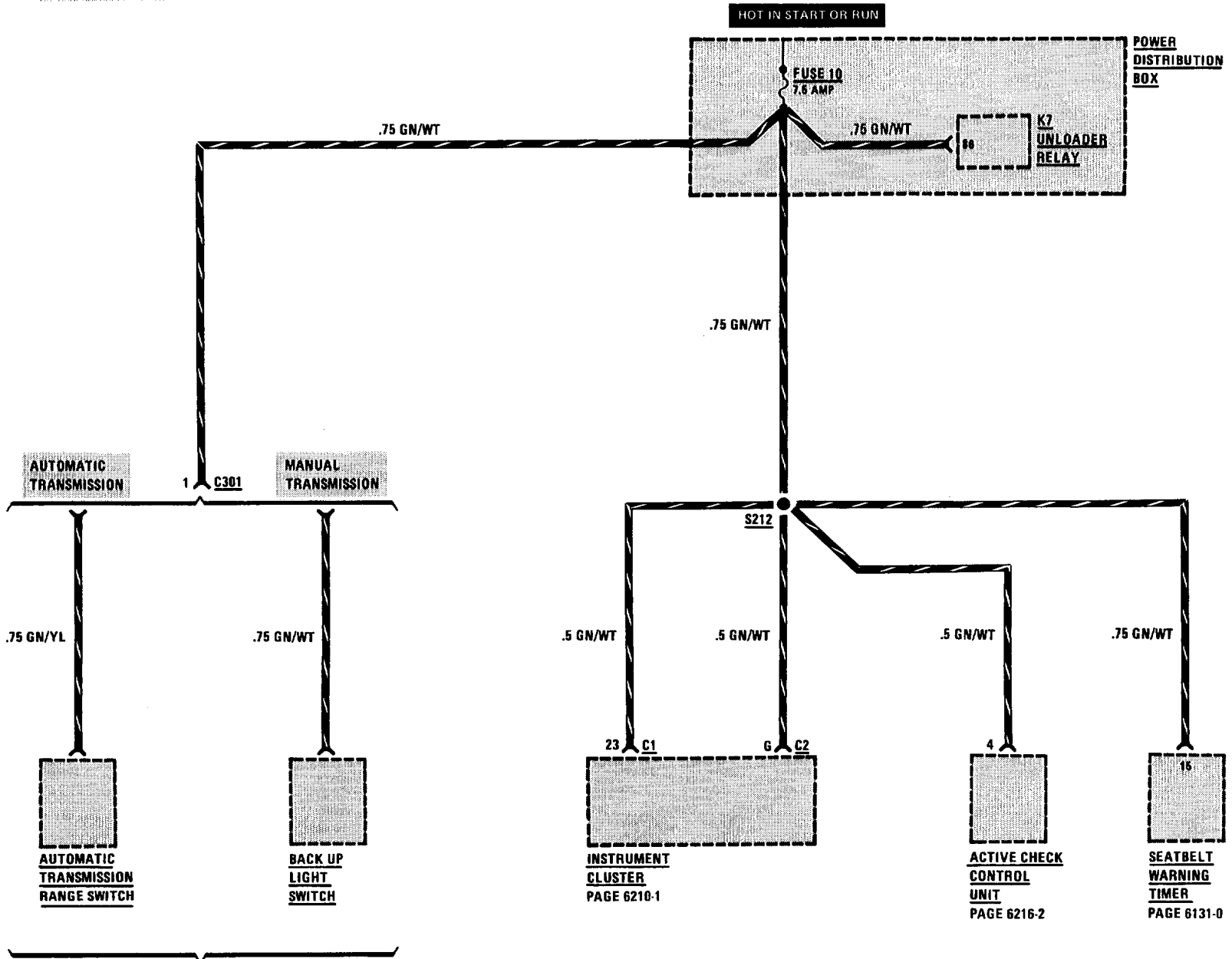



FUSE DETAILS: FUSE 20

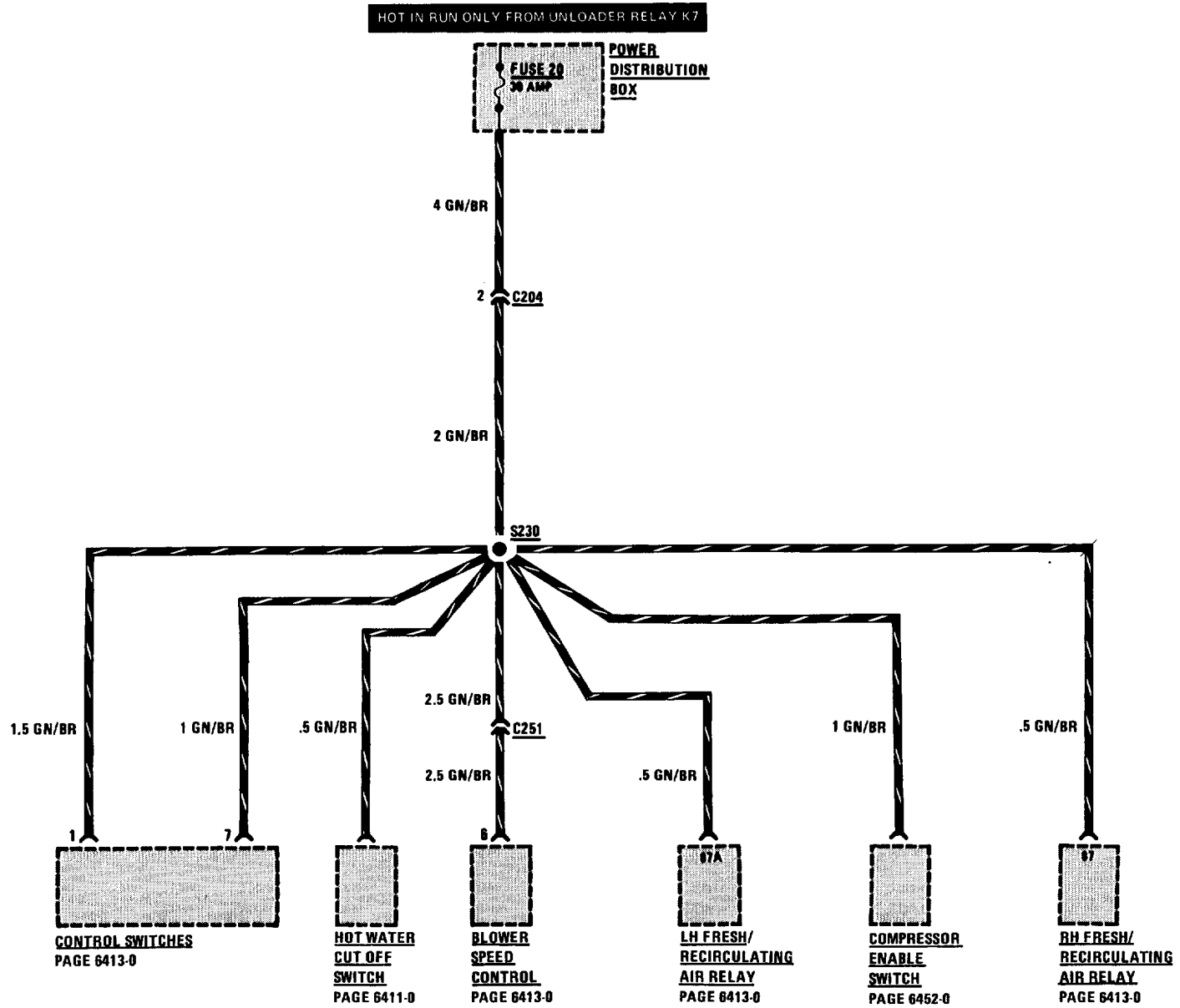



FUSE DETAILS: FUSE 4, 5 AND 6

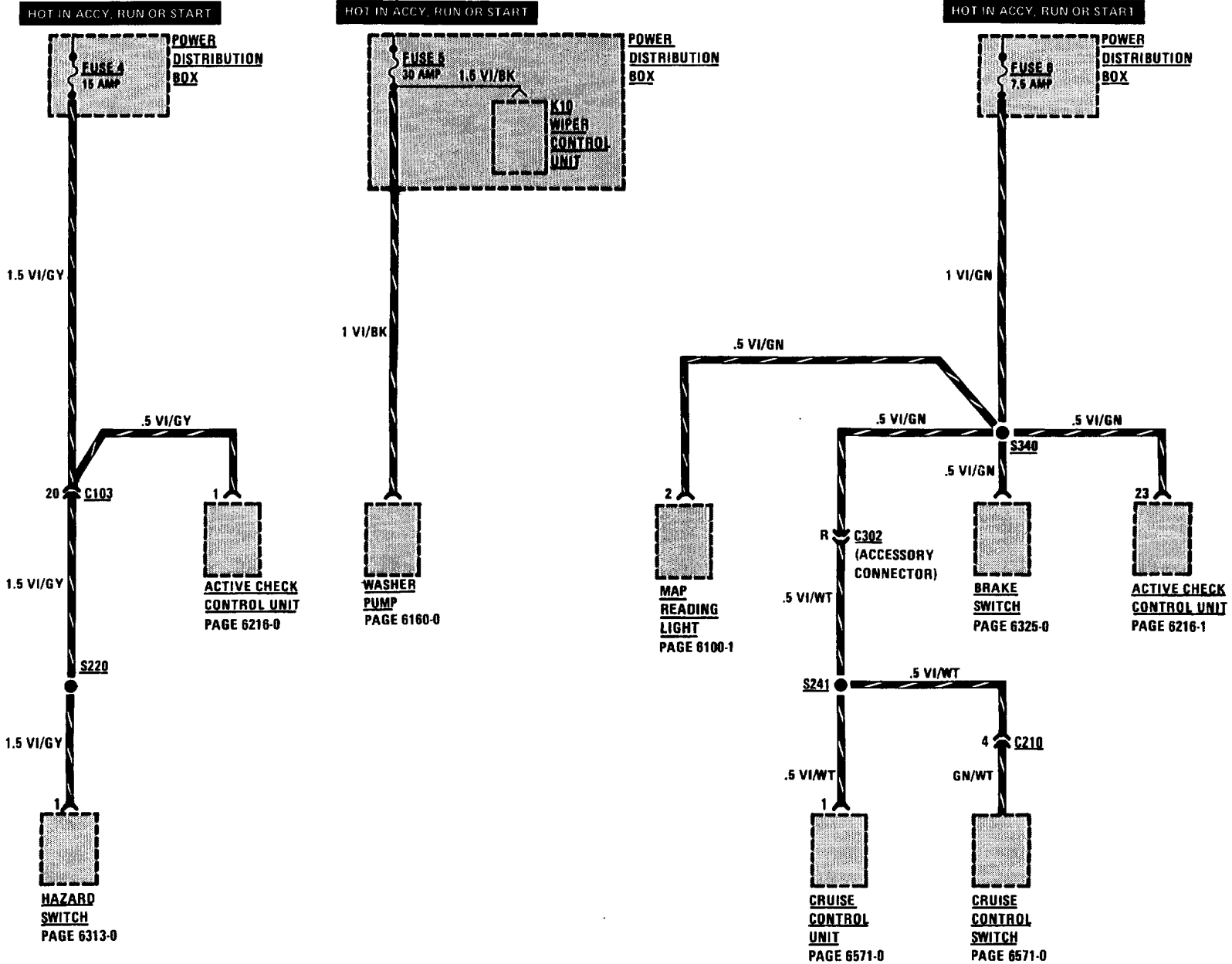

FUSE DETAILS: FUSES 8, 12 AND 19

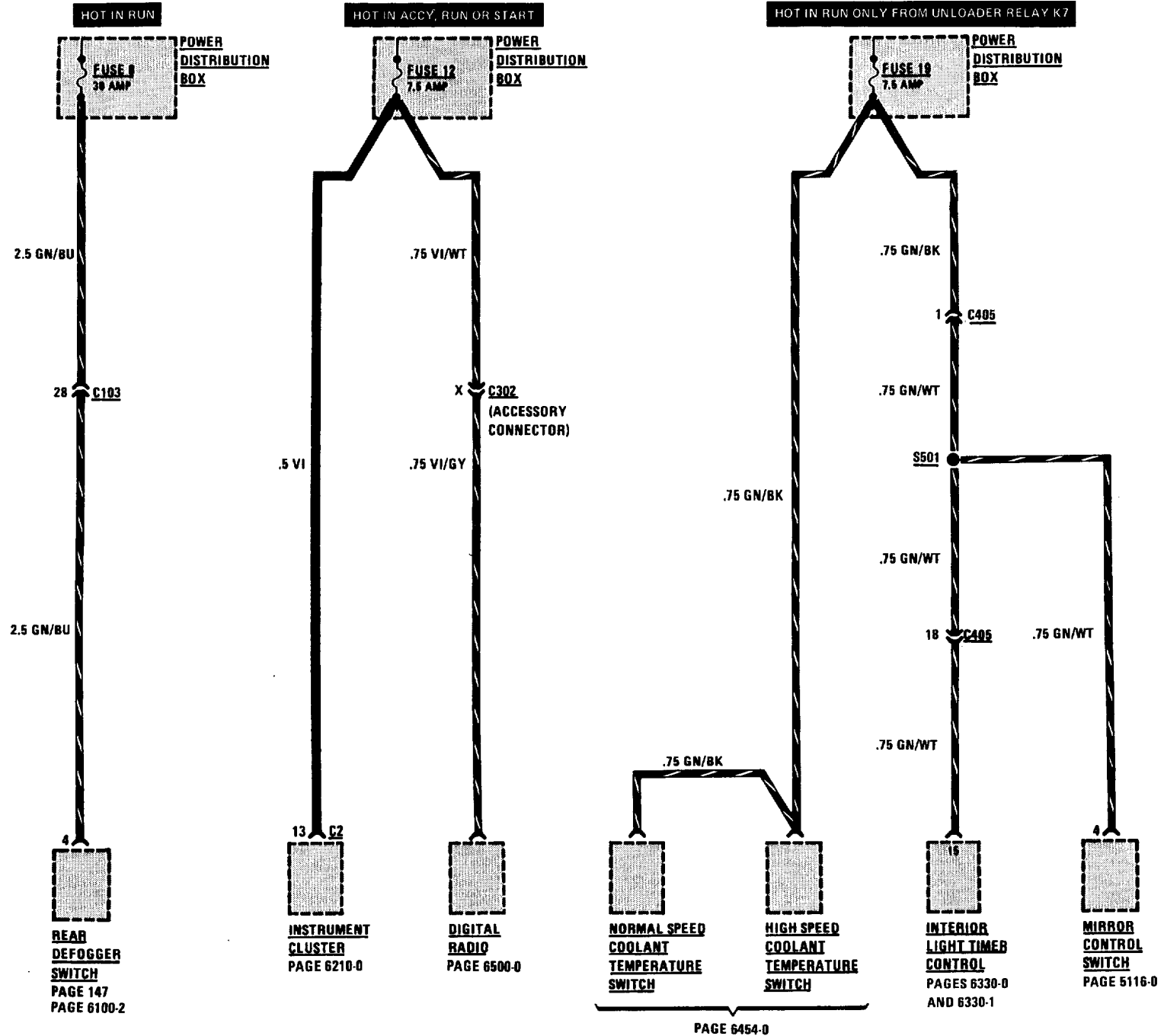





**GROUND DISTRIBUTION (G200 PARTIAL AND G201)**

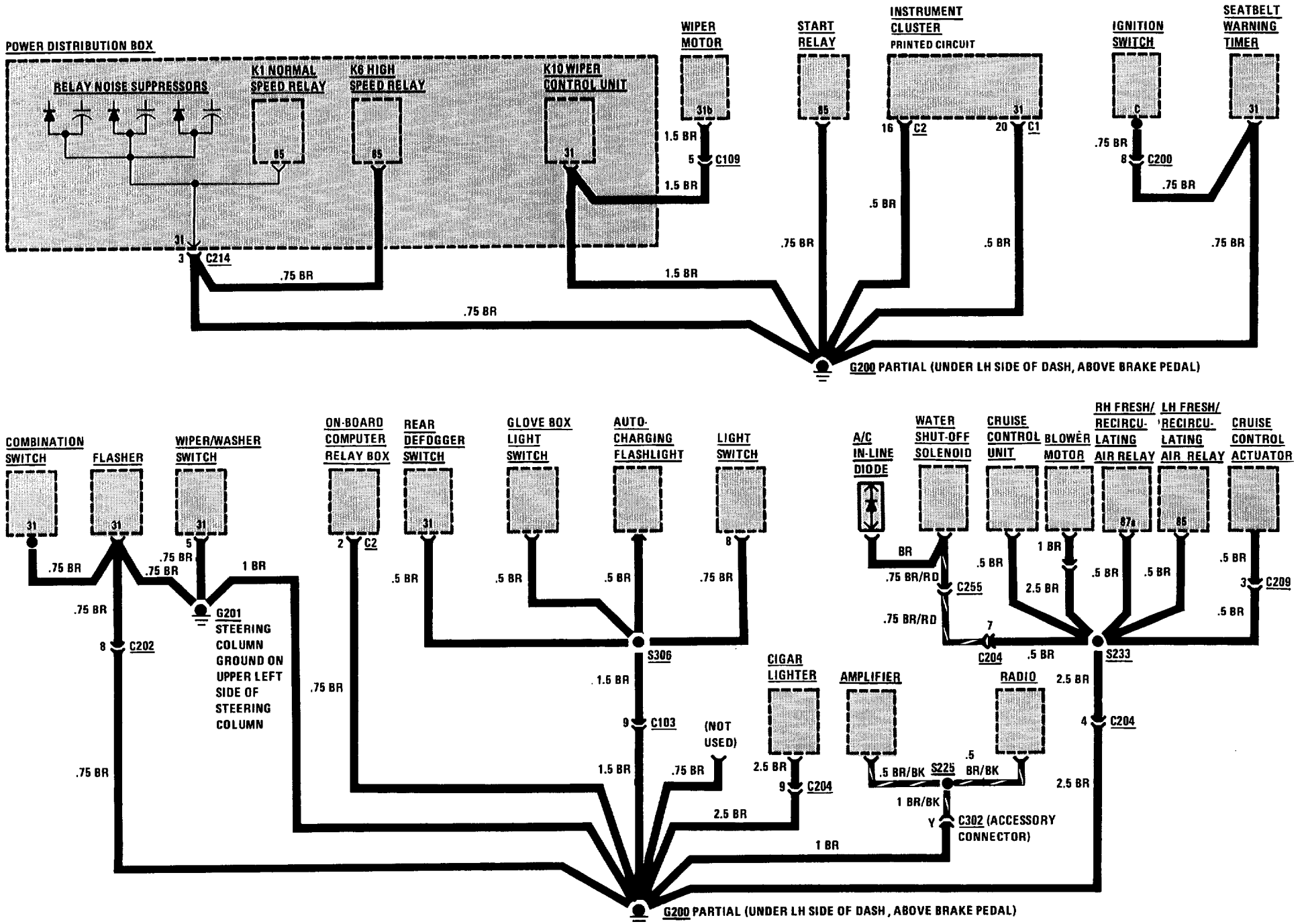

**GROUND DISTRIBUTION (G200 PARTIAL AND G300)**

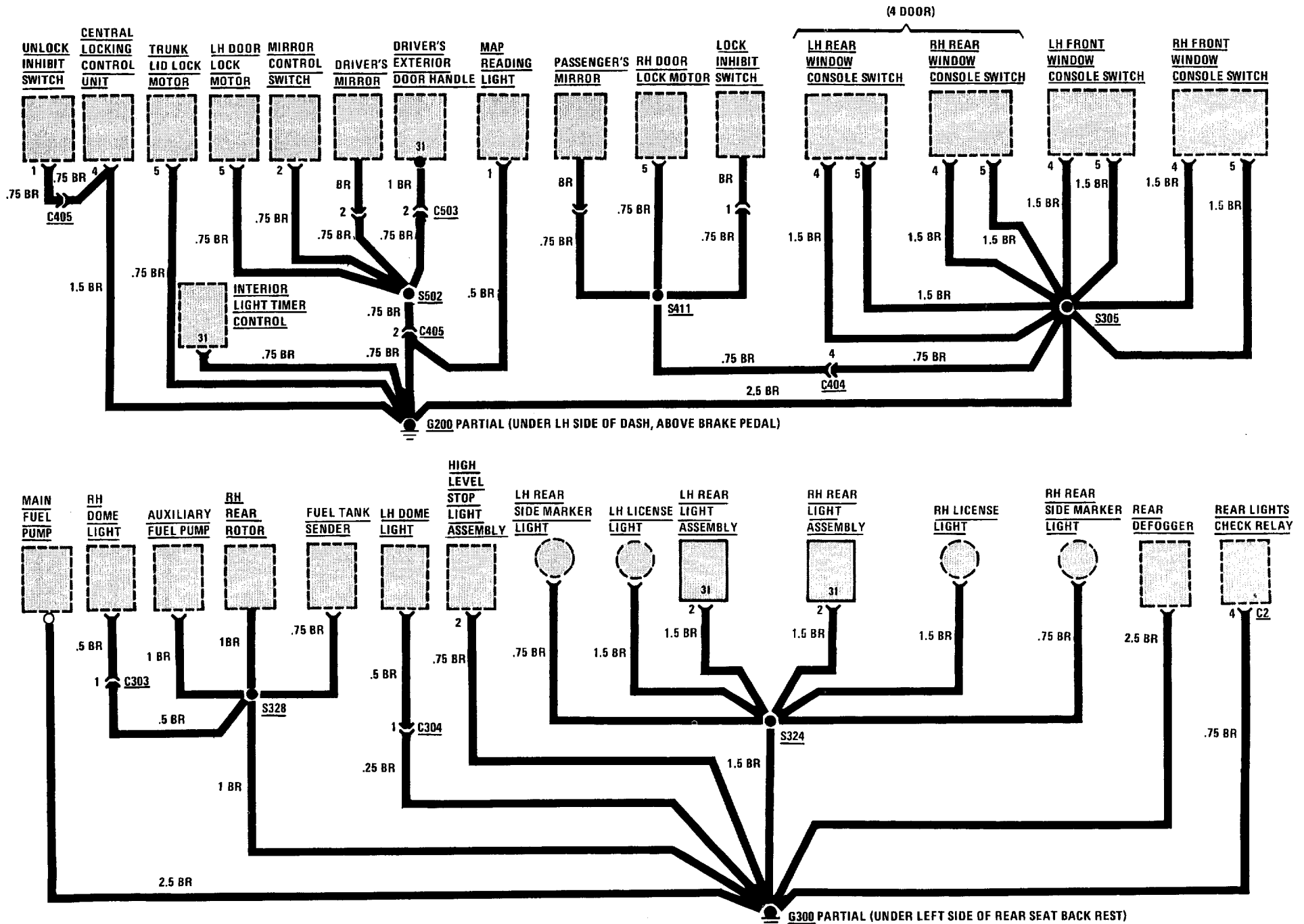



GROUND DISTRIBUTION: (G105 AND G106)

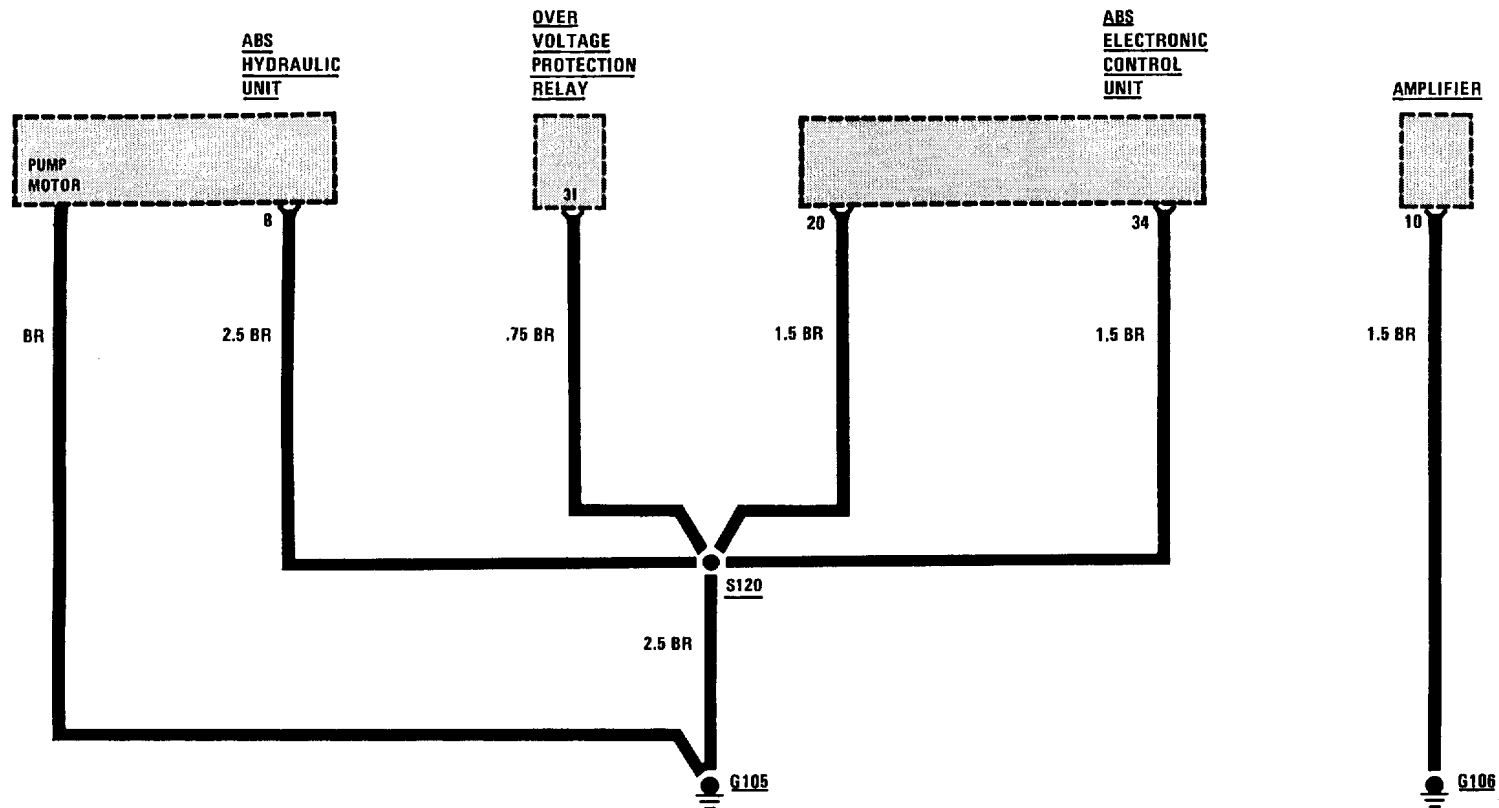







# 1250-0 ENGINE CONTROL BLOCK DIAGRAMS

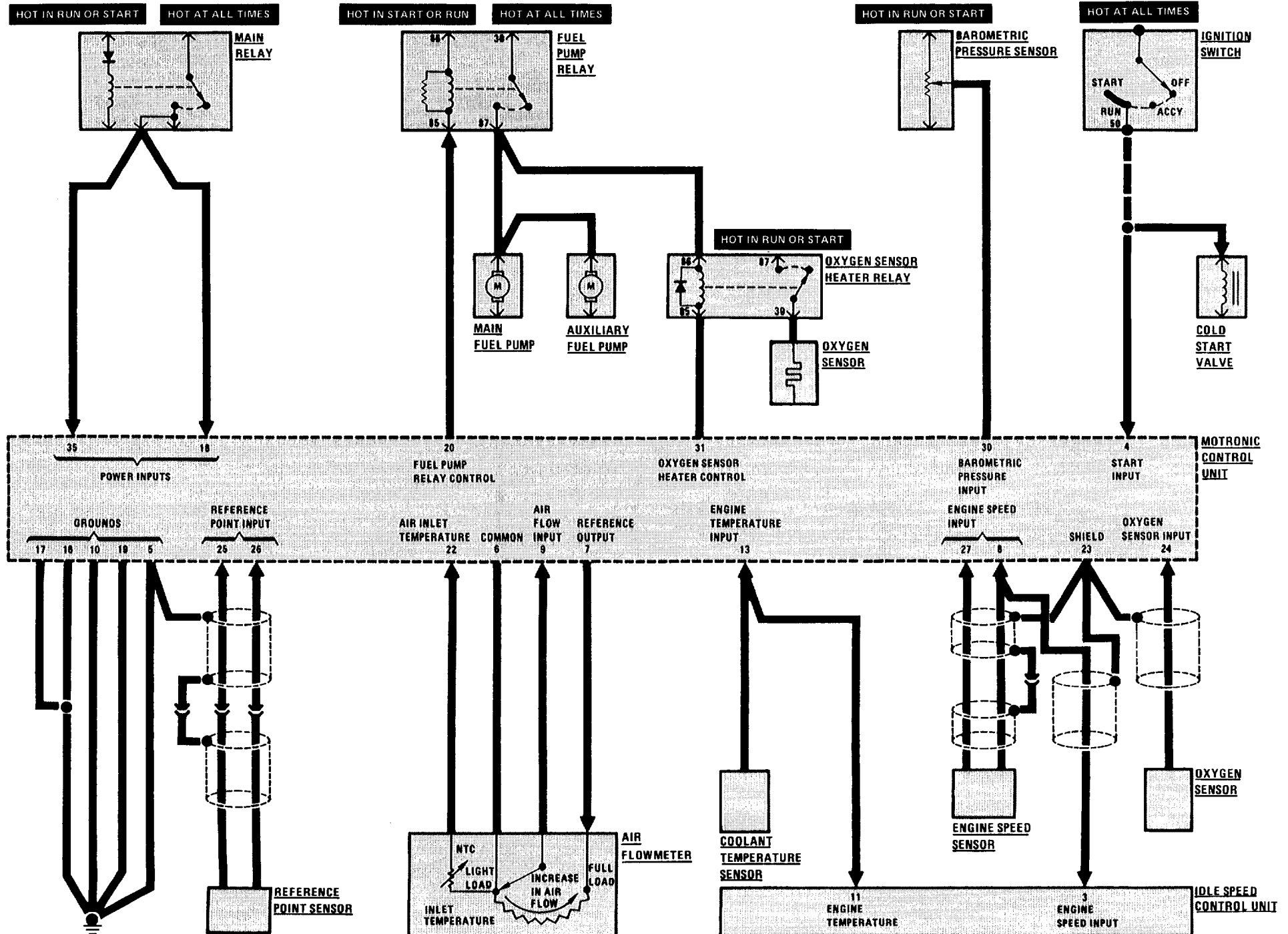

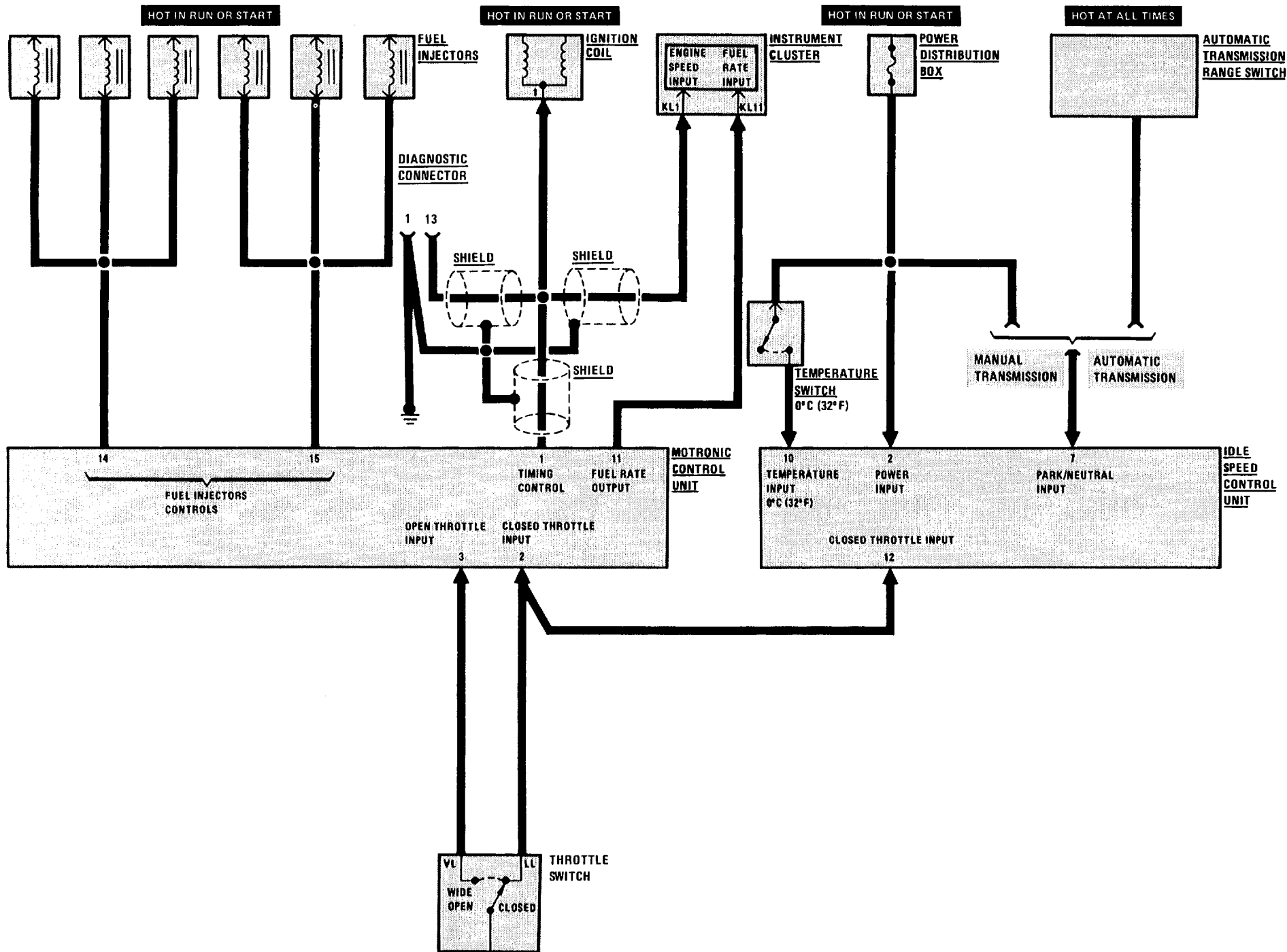

## FUEL DELIVERY WITH ON-BOARD COMPUTER

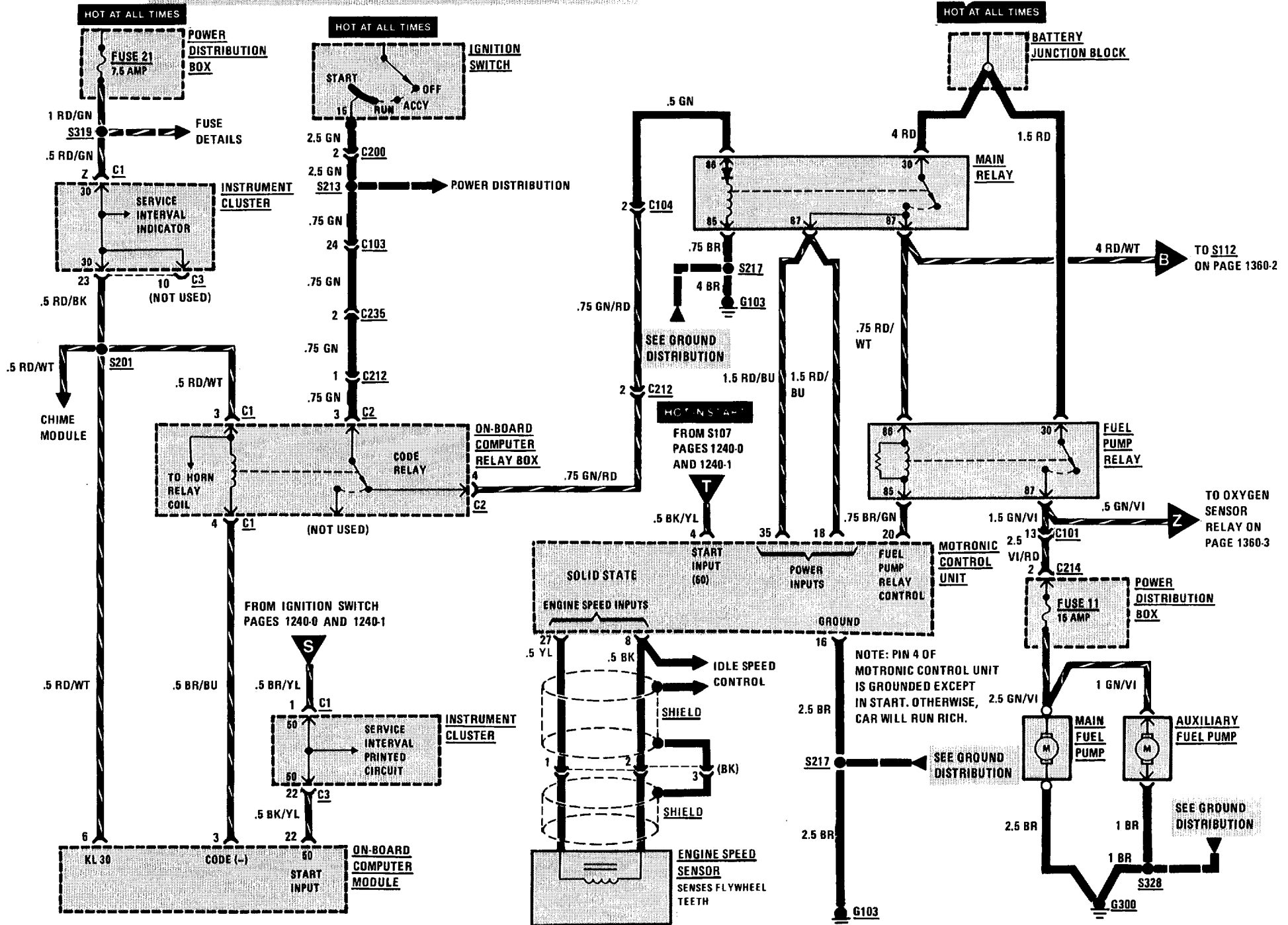

FUEL DELIVERY WITH MULTI-FUNCTION CLOCK

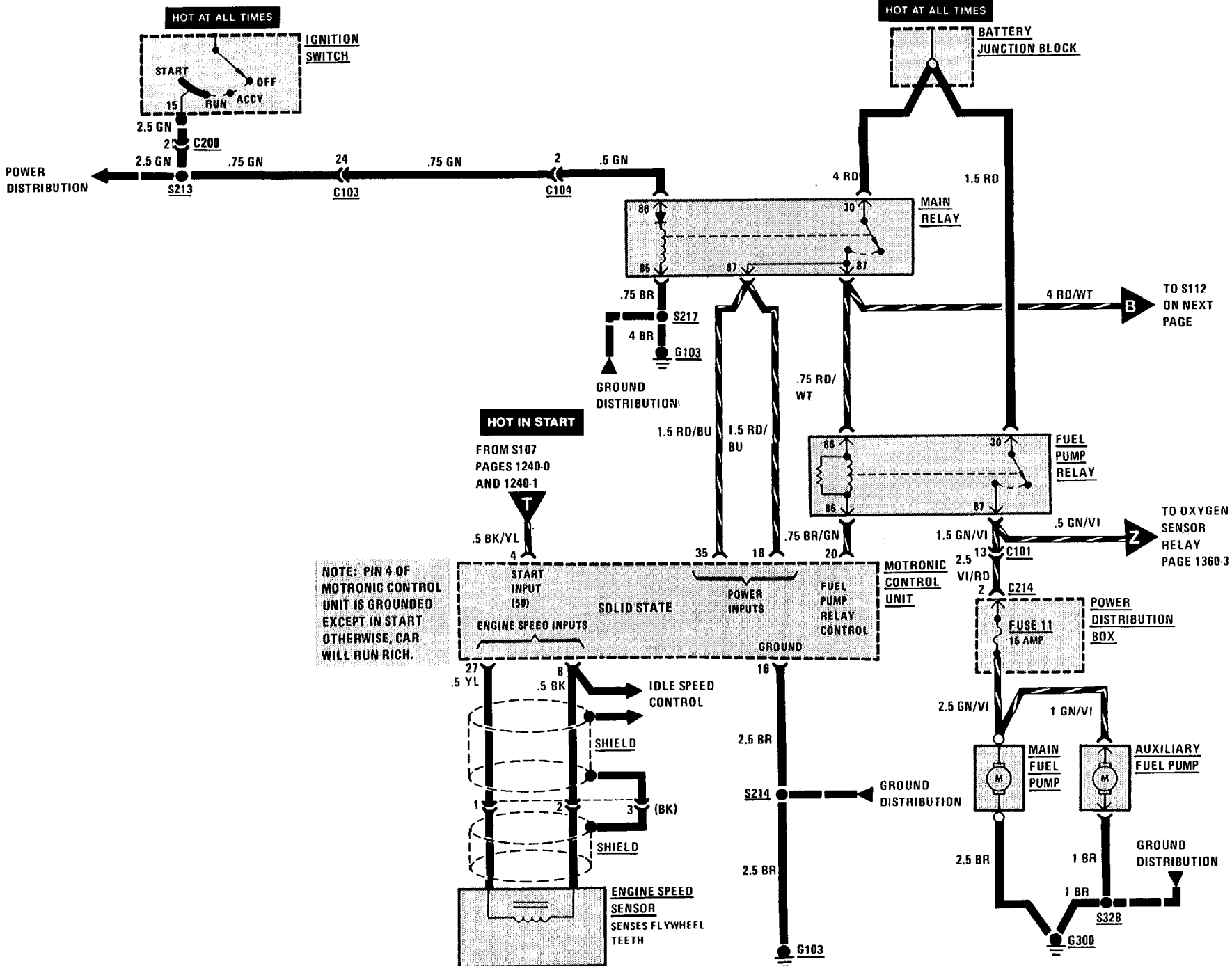





**IDLE SPEED CONTROL**

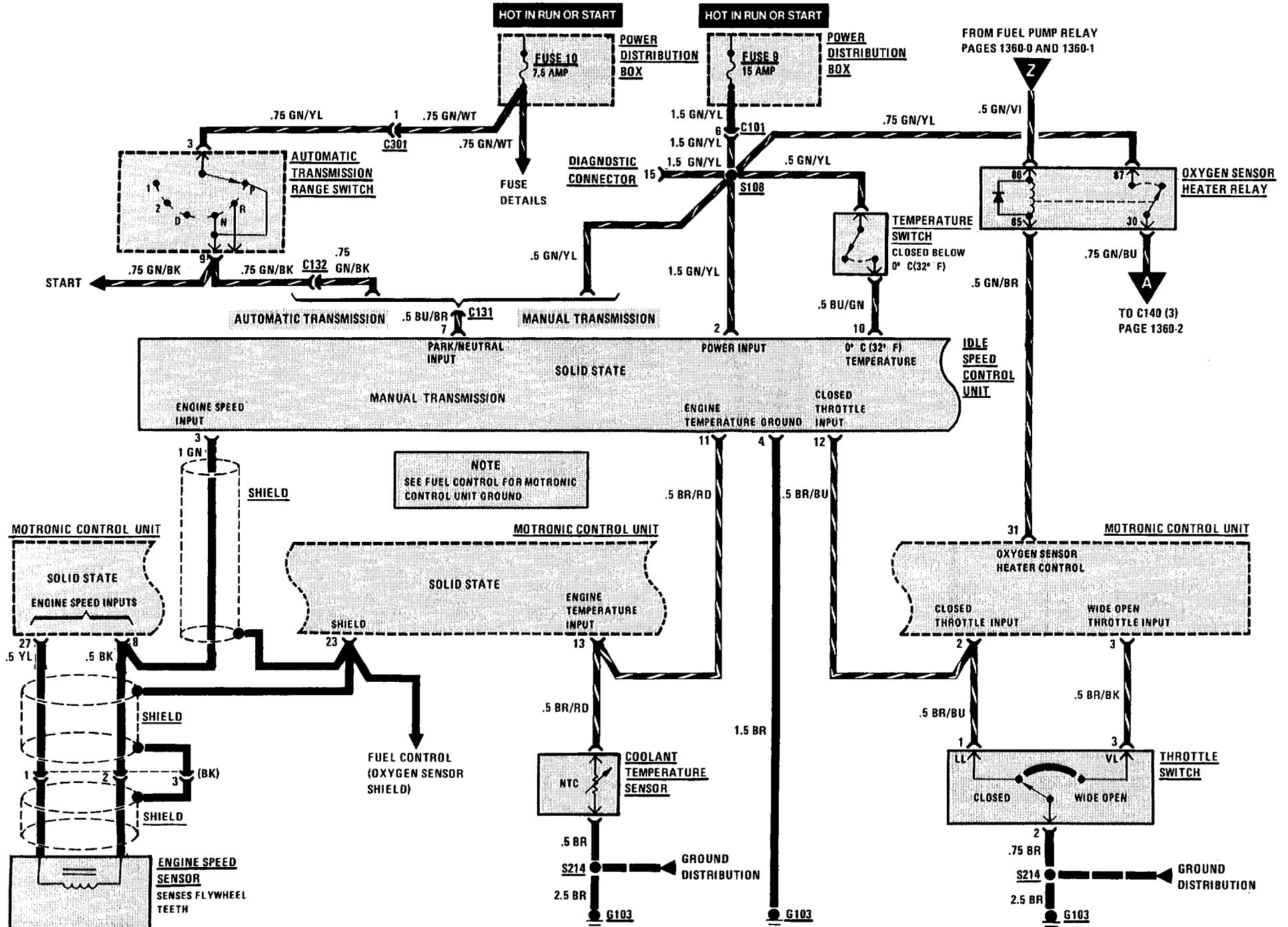

**IDLE SPEED CONTROL/IGNITION**

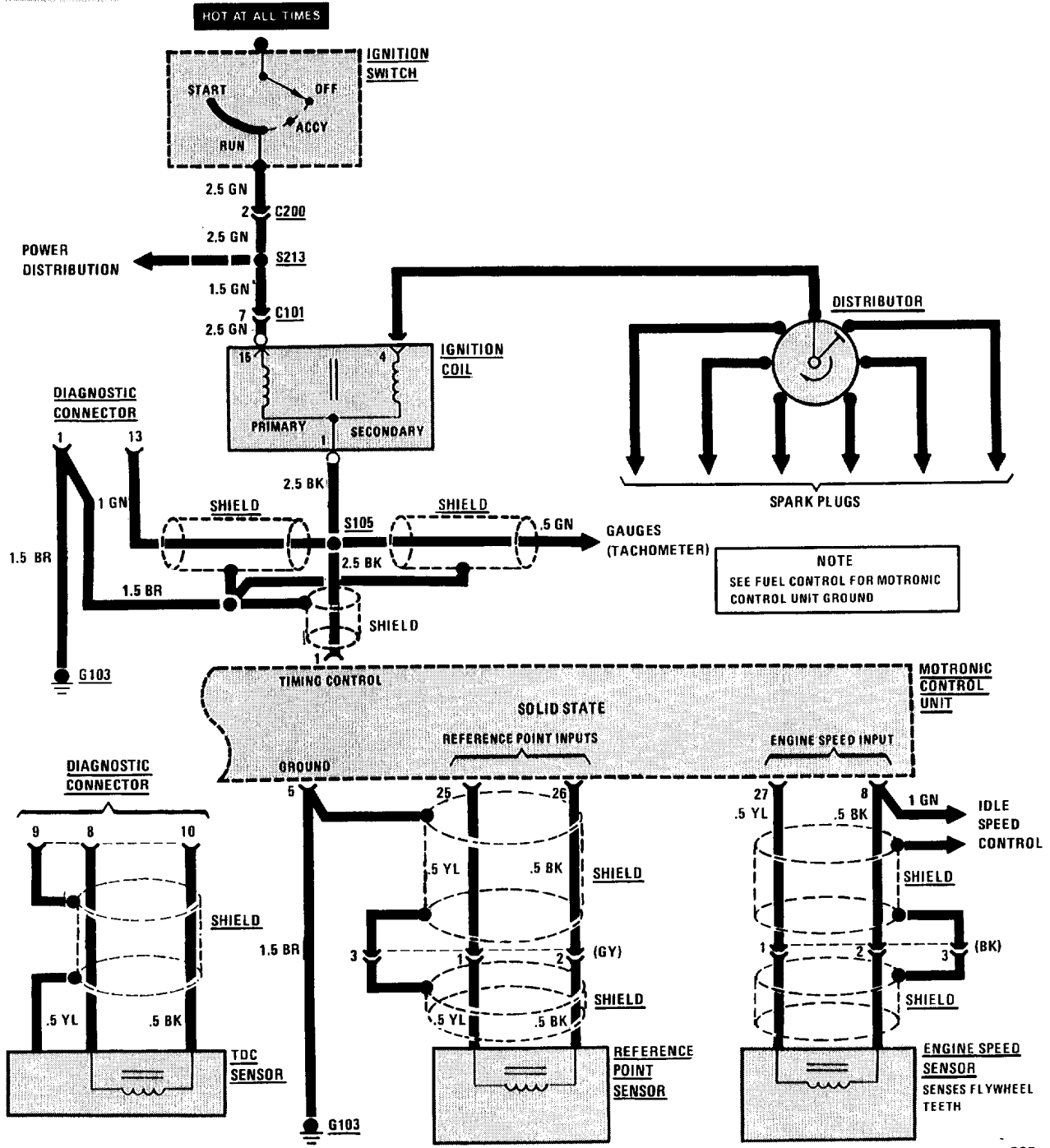
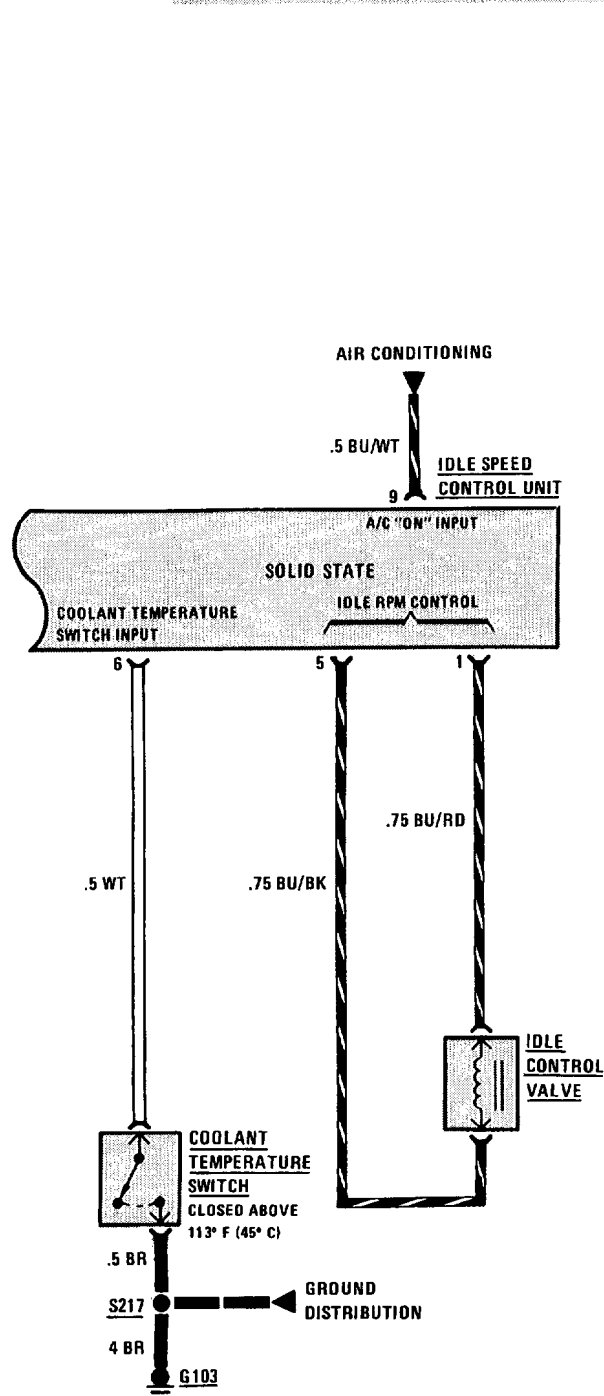

# 3435-0 BRAKE WARNING SYSTEM

## EARLY PRODUCTION

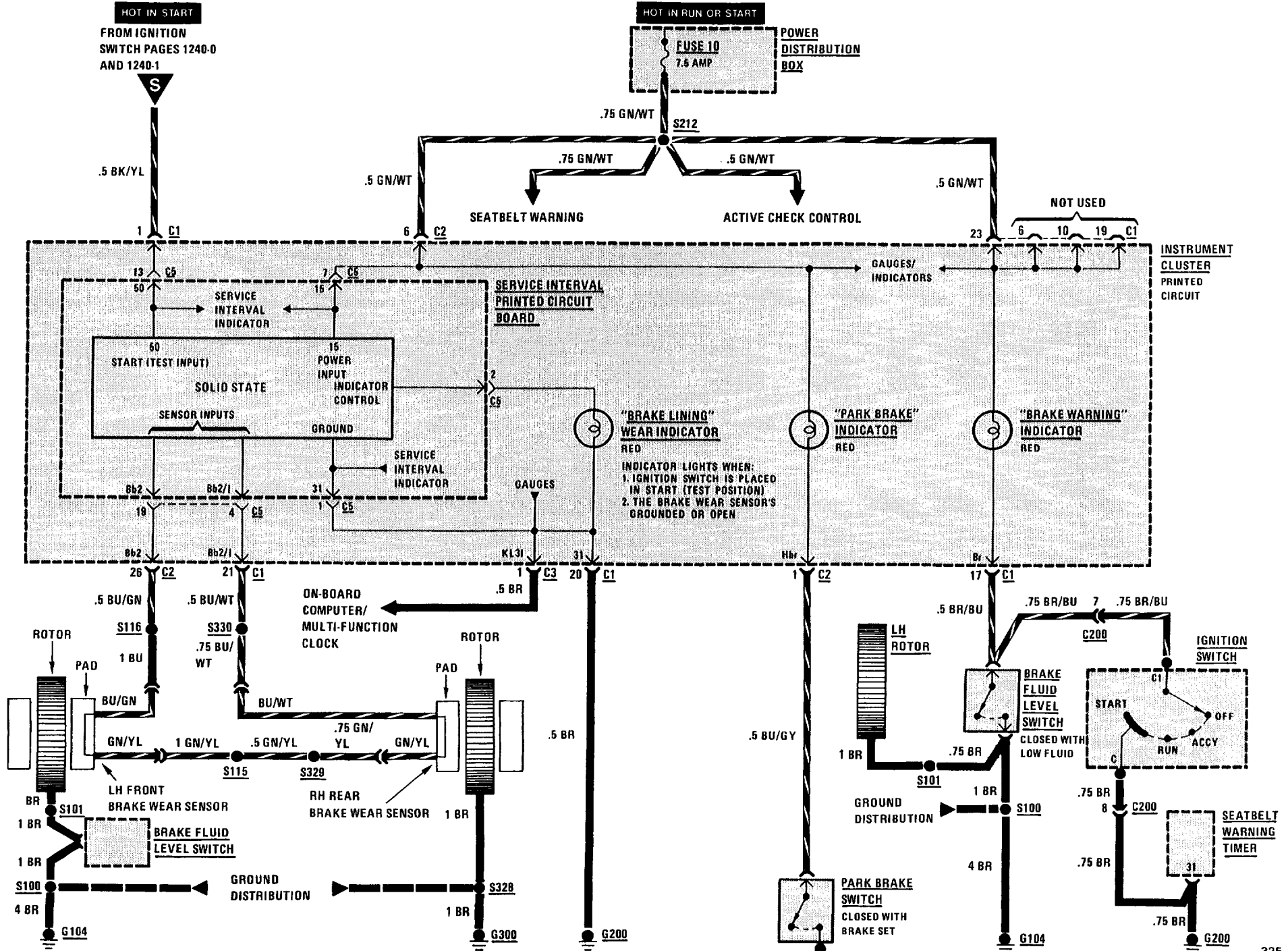





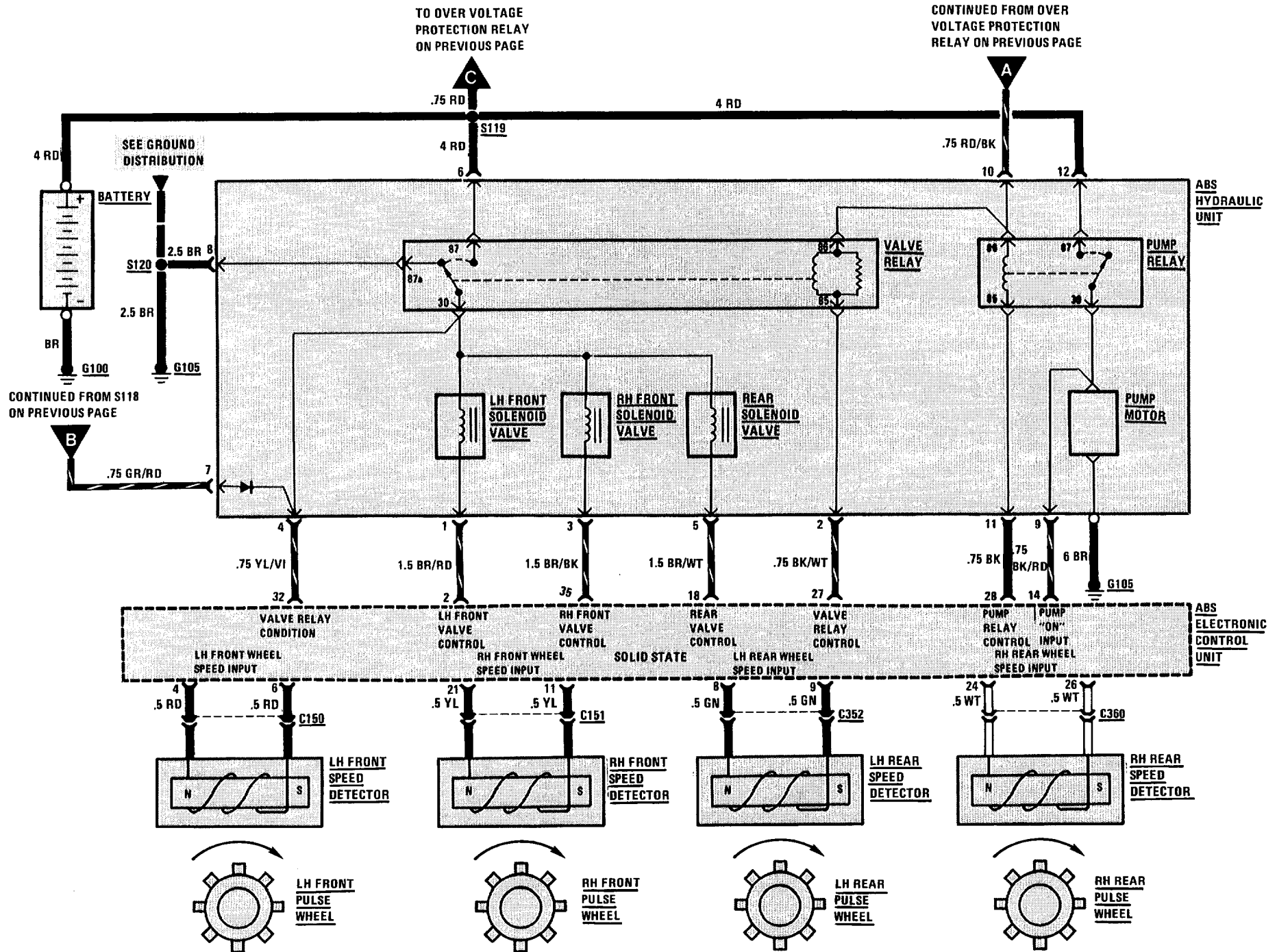





# 5126-0 CENTRAL LOCKING

## 2 DOOR (SELECT)

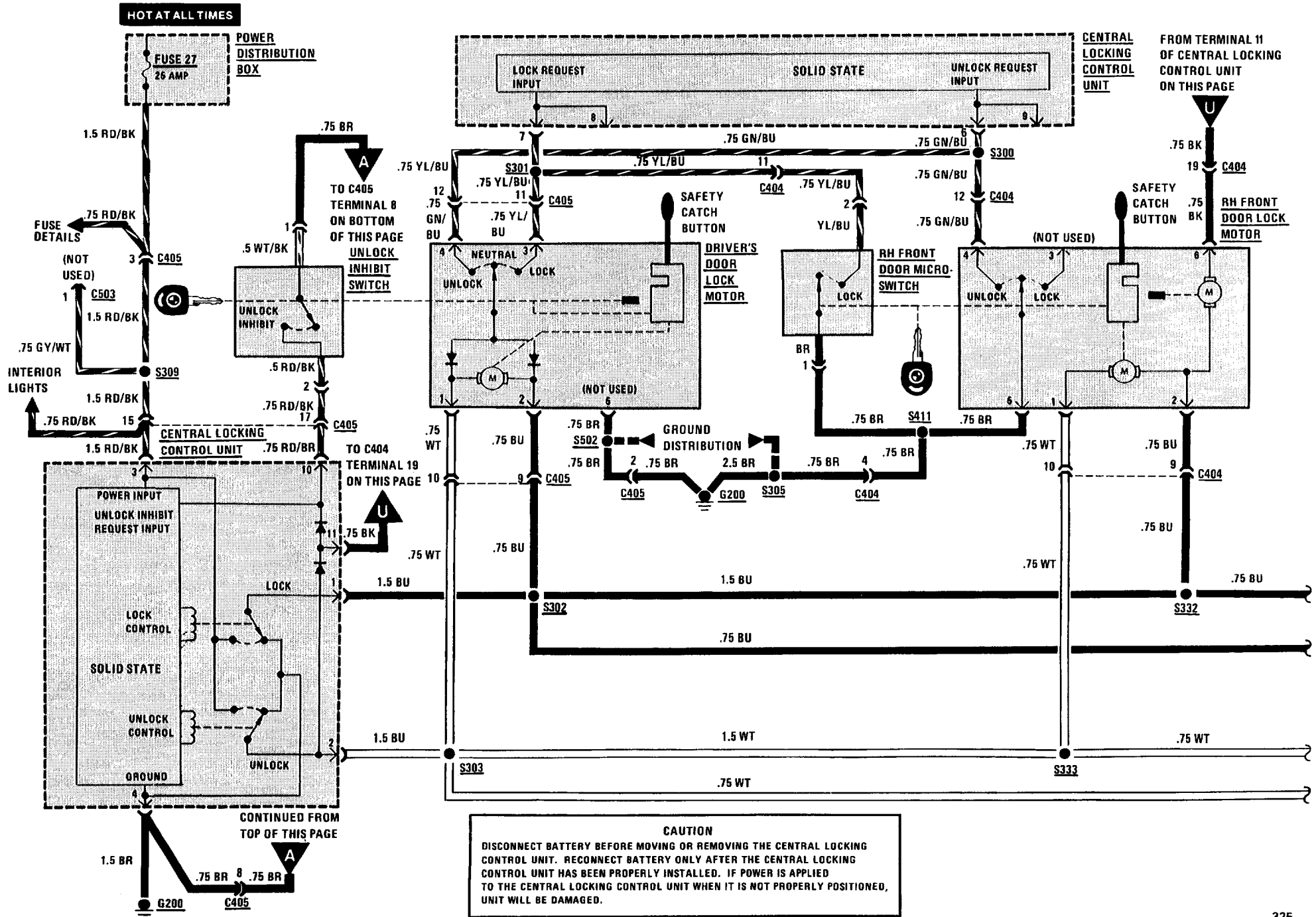

2 DOOR (CONTROL)

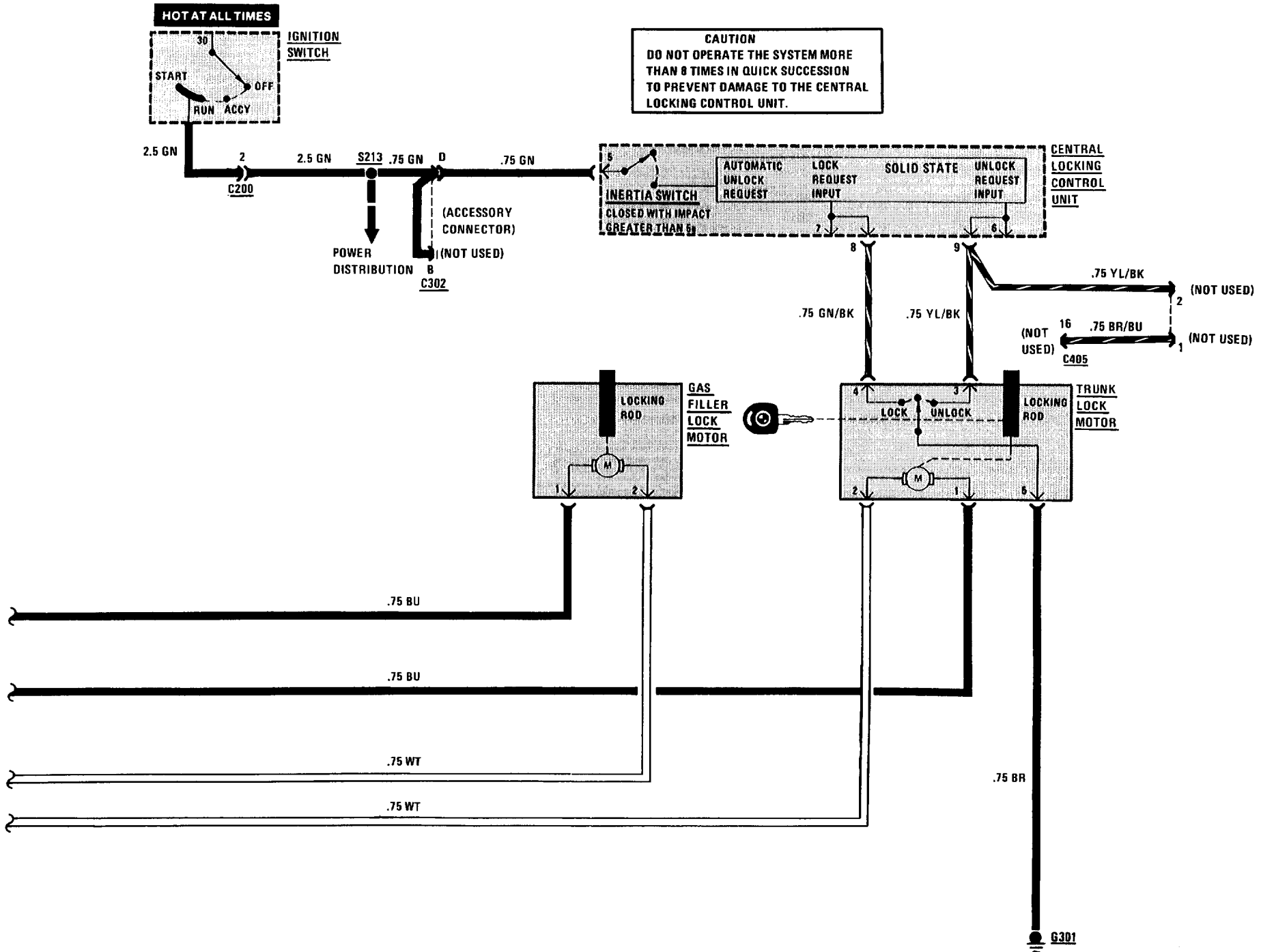

# 5126-2 CENTRAL LOCKING

## 4 DOOR (SELECT)

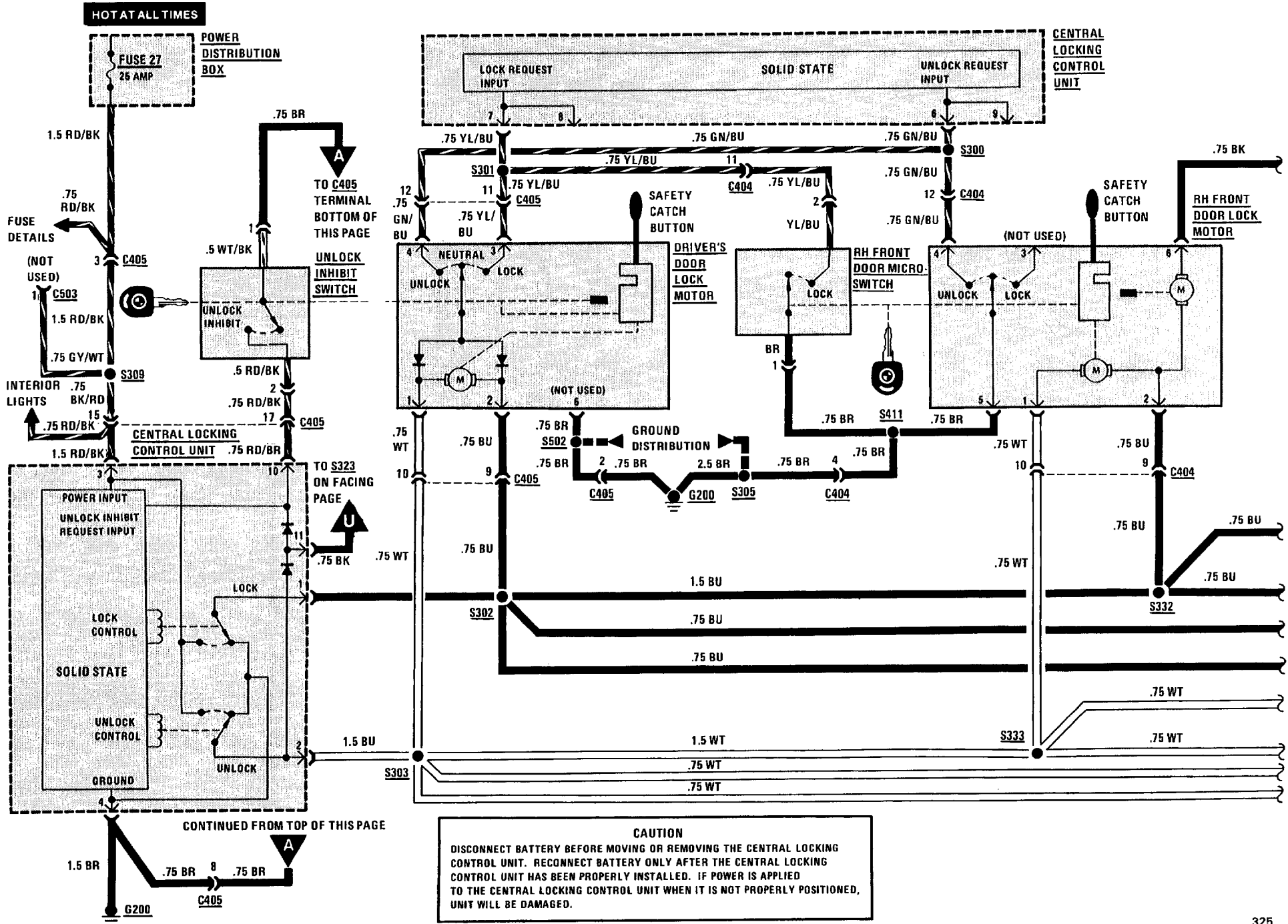

4 DOOR (CONTROL)

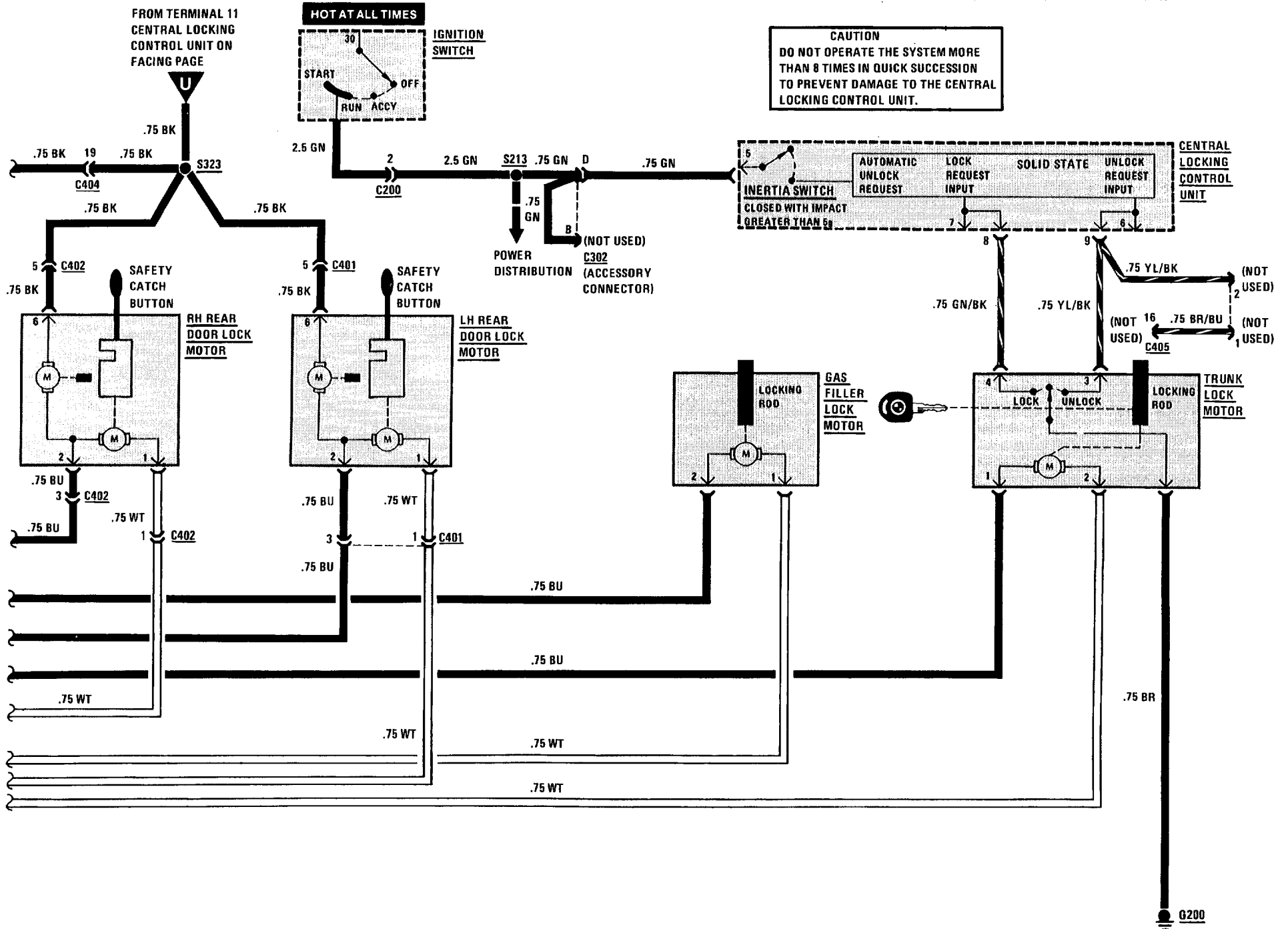

## 5126-4 CENTRAL LOCKING

### TROUBLESHOOTING HINTS

- Try the following check before doing the System Check.

Check Fuse 27 by operating the On-Board Computer.

- Go to System Check for a guide to normal operation.
- Go to System Diagnosis for diagnostic tests.

### SYSTEM CHECK

- Operate the controls in the sequence listed in the System Check Table.
- Refer to the Repair Action for the Response received. Tests follow in the System Diagnosis.
- After any repair, repeat the System Check to verify proper system operation.

**NOTE:** Before replacing any system component, check all the connectors, splices and wiring to that component.

**SYSTEM CHECK TABLE**

OPERATION	RESPONSE	REPAIR ACTION
1. Insert the key in the Driver's door and turn to LOCK	All doors lock	None, proceed to Operation 2.
	Some doors lock	Repair/replace the suspect Door Lock Motor circuit.
	No doors lock	Proceed to Operation 4.
2. Turn the key to UNLOCK INHIBIT (clockwise until key is horizontal)	All doors double lock (Safety Catch Buttons cannot be pulled up by hand)	None, proceed to Operation 3.
	Driver's door double locks and only some of the other doors double lock	Repair/replace the suspect Door Lock Motor(s).
	Driver's door double locks but all the other doors do not double lock	Perform Test B.
	Driver's door does not double lock	Mechanical problem, see BMW Troubleshooting Manual.

**SYSTEM CHECK TABLE (CONT'D)**

OPERATION	RESPONSE	REPAIR ACTION
3. Turn the key to UNLOCK	All doors unlock	None, proceed to Operation 4.
	Some doors unlock	Repair/replace the suspect Door Lock Motor circuit
	No doors unlock	Proceed to Operation 5
4. Insert the key in the Passenger's door and turn to LOCK	All doors lock	If the doors did not lock in Operation 1, repair/replace the Driver's Door Lock Switch, otherwise proceed to Operation 5
	Some doors lock	Repair/replace the suspect Door Lock Motor circuit
	No doors lock	If all the doors locked in Operation 1, repair/replace the Right Front Door Microswitch. If the doors did not lock in Operation 1, perform Test A
5. Insert the key in the Passenger's door and turn to UNLOCK	All doors unlock	If all the doors did not unlock in Operation 3, repair/replace the Driver's Door Lock Switch, otherwise proceed to Operation 6
	Some doors unlock	Repair/replace the suspect Door Lock Motor
	No doors unlock	If all the doors unlocked in Operation 3, repair/replace the Passenger's Door Lock Switch. If the doors did not unlock in Operation 3, perform Test C
6. Get in the car and close and lock all doors Turn the Ignition Switch to RUN	Doors remain locked	None, proceed to Operation 7
	Doors unlock	Repair/replace the Central Locking Control Unit
7. Get out of the car  Insert the key in the Driver's door and turn to LOCK  Unlock each of the doors by pulling up the Safety Catch Buttons	All doors can be unlocked	None, proceed to Operation 8
	All doors remain secure	Disconnect the connector from the Central Locking Control Unit and check for a short to ground in the BK wires at terminal 11. • If short to ground is not present, replace the Central Locking Control Unit • If short to ground is present isolate the wiring from the Door Lock Motors one at a time to find the short

SYSTEM CHECK TABLE (CONT'D)

OPERATION	RESPONSE	REPAIR ACTION
8. Insert the key in the Trunk Cylinder Switch. Turn the key to LOCK	Trunk locks	None, proceed to Operation 9
	Trunk does not lock	If the doors lock, repair/replace the Trunk Lock Motor Circuit or Trunk Lock Motor If the doors do not lock, repair/replace the Trunk Switch
9. Turn the key to UNLOCK	Trunk unlocks	None, proceed to Operation 10
	Trunk does not unlock	If the doors unlock, repair/replace the Trunk Lock Motor circuit or Trunk Lock Motor. If the doors do not unlock, repair/replace the Trunk Switch. Repair/replace the Central Locking Control Unit if the Trunk Switch Circuit is OK
10. Turn the key back to LOCK	Gas Filler locks	None, proceed to Operation 11
	Gas Filler does not lock	Repair/replace the Gas Filler Lock Motor circuit
11. Turn the key to UNLOCK	Gas Filler unlocks	None
	Gas Filler does not unlock	Repair/replace the Gas Filler Lock Motor circuit

- If all results are normal, the system is OK.

SYSTEM DIAGNOSIS

- Do the following tests below when directed by the System Check Table.

A: CONTROL UNIT LOCK TEST (TABLE 1)

Measure: VOLTAGE At: CONTROL UNIT CONNECTOR (Connected)		
Measure Between	Correct Voltage	For Diagnosis
3 (RD/BK) & Ground	Battery	See 1
3 (RD/BK) & 4 (BR)	Battery	See 2
<ul style="list-style-type: none"> <li>• If the voltages are correct, proceed to Table 2.</li> <li>1. Check the RD/BK wire for an open.</li> <li>2. Check the BR wire for an open to ground (see schematic).</li> </ul>		

A: CONTROL UNIT LOCK TEST (TABLE 2)

Connect: A FUSED JUMPER At: CONTROL UNIT CONNECTOR (Connected)		
Jumper Between	Correct Result	For Diagnosis
7 (YL/BU) & Ground	Doors lock	See 1
<ul style="list-style-type: none"> <li>• If the result is correct, repair/replace the switches and related wiring (see schematic).</li> <li>1. Proceed to Table 3.</li> </ul>		

**A: CONTROL UNIT LOCK TEST  
(TABLE 3)**

<b>Connect: FUSED JUMPERS</b>		
<b>At: CONTROL UNIT CONNECTOR (Disconnected)</b>		
Jumper Between	Correct Result	For Diagnosis
1 (BU) & 3 (RD/BK) 2 (WT) & 4 (BR)	Doors lock	See 1
<ul style="list-style-type: none"> <li>If the result is correct, replace the Central Locking Control Unit.</li> </ul>		
<ol style="list-style-type: none"> <li>Check the BU wire to splice S302 and the WT wire to splice S303 for opens (see schematic).</li> </ol>		

**B: UNLOCK INHIBIT TEST**

<b>Connect: A FUSED JUMPER</b>		
<b>At: CONTROL UNIT CONNECTOR (Connected)</b>		
Jumper Between	Correct Result	For Diagnosis
10 (RD/BR) & Ground	Doors double lock	See 1
<ul style="list-style-type: none"> <li>If the result is correct, check the RD/BR, RD/BK, WT/BK, and BR wires for opens (see schematic). Replace the Unlock Inhibit Switch if the wires and connections are OK.</li> </ul>		
<ol style="list-style-type: none"> <li>Check the BK wires for opens (see schematic). Replace the Central Locking Control Unit, if the wires and connections are OK.</li> </ol>		

**C: CONTROL UNIT UNLOCK TEST**

<b>Connect: A FUSED JUMPER</b>		
<b>At: CONTROL UNIT CONNECTOR (Connected)</b>		
Jumper Between	Correct Result	For Diagnosis
6 (GN/BU) & Ground	Doors unlock	See 1
<ul style="list-style-type: none"> <li>If the result is correct, repair/replace the switches and related wiring (see schematic).</li> </ul>		
<ol style="list-style-type: none"> <li>Replace the Central Locking Control Unit.</li> </ol>		

**CIRCUIT DESCRIPTION**

The Central Locking System is controlled by the Central Locking Control Unit. This unit senses when a lock switch is moved by a key, and sends the appropriate signal to drive the Motors. The Central Lock Control Unit controls the Door Locks, Gas Filler Lock and Trunk Lock. The unit also has an Inertia Switch which closes on impact greater than 5g. If in RUN or START the locks are then unlocked.

**Lock**

When the Key is inserted into a lock and turned clockwise, the Lock Switch moves to LOCK and grounds terminal 7 of the Central Locking Control Unit. The unit then activates the Lock Relay and applies voltage from Fuse 27 to the Lock Motor, which is grounded through the WT wire, Central Locking Control Unit and BR wire. The Lock Motor then pulls the lock down. The door locks also control the Trunk Lock and Gas Filler Lock.

**Unlock**

When the key is turned counterclockwise, terminal 6 of the Central Locking Control Unit is grounded through the Lock Switch. The Central Locking Control Unit then activates the Unlock Relay and applies voltage from Fuse 27, through the WT wire to the Lock Motor. The motor is grounded through the BU wire, Central Locking Control Unit, and BR wire. The polarity is reversed and the motor pushes the lock up.

**Unlock Inhibit**

When the key is inserted into the Driver's Lock and turned clockwise past the LOCK position, the Unlock Inhibit mechanism is engaged. This mechanically inserts a bar into the Driver's Lock and prevents unlocking through use of the Safety Catch Button. When in the Unlock Inhibit position, ground is applied to the Unlock Inhibit Motors in the other lock units. The Central Locking Control Unit is grounded at terminal 10 and then activates the Lock Relay. Voltage is now applied to the Unlock Inhibit Motors through the BU wire. They are now activated and engage the other Unlock Inhibit mechanisms. The direction of the motors is reversed when the doors are unlocked (see Unlock).

**Trunk Lock**

The Trunk Lock operates in a manner similar to the Door Locks.



4 DOOR EARLY PRODUCTION

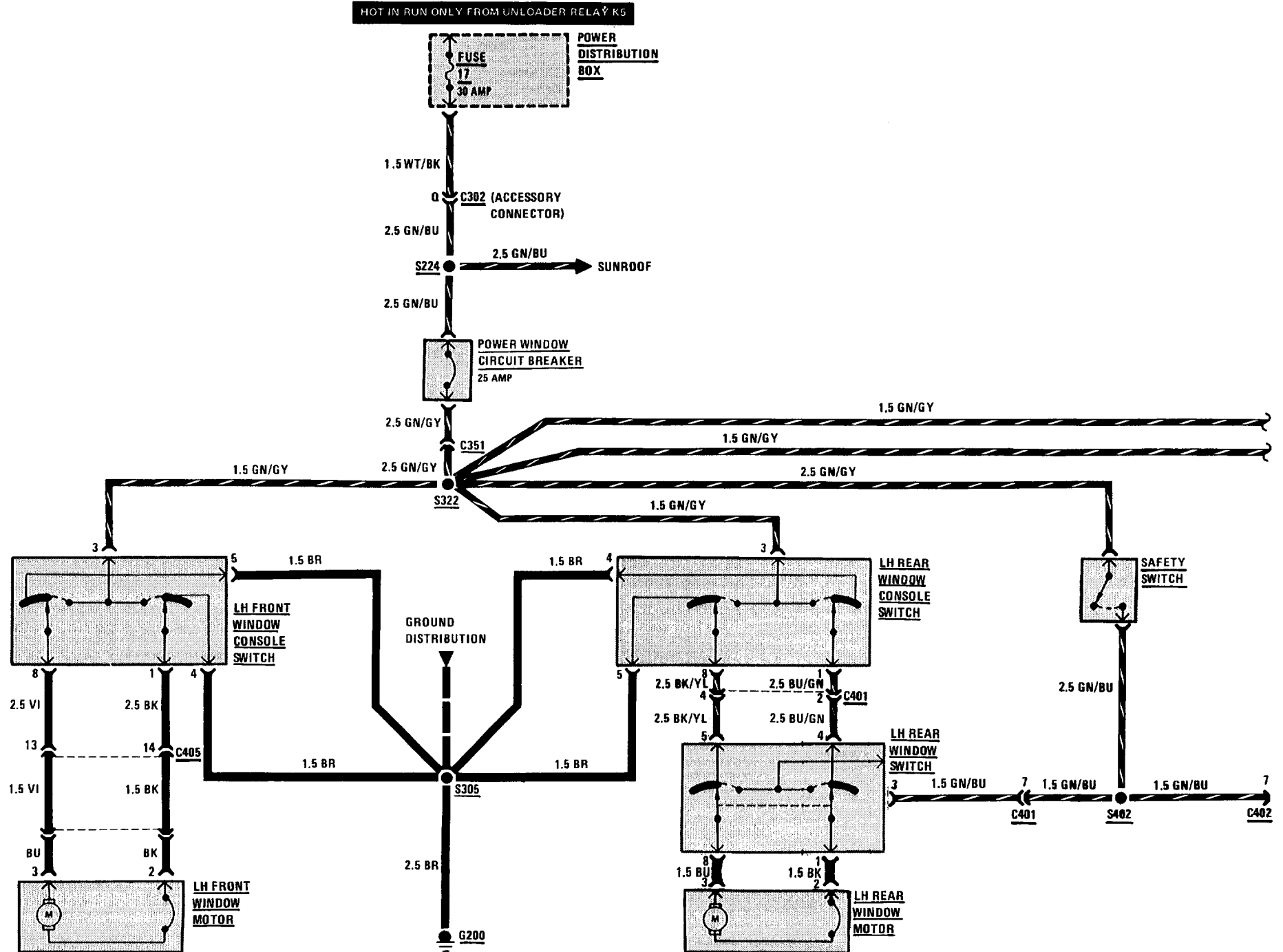

4 DOOR EARLY PRODUCTION

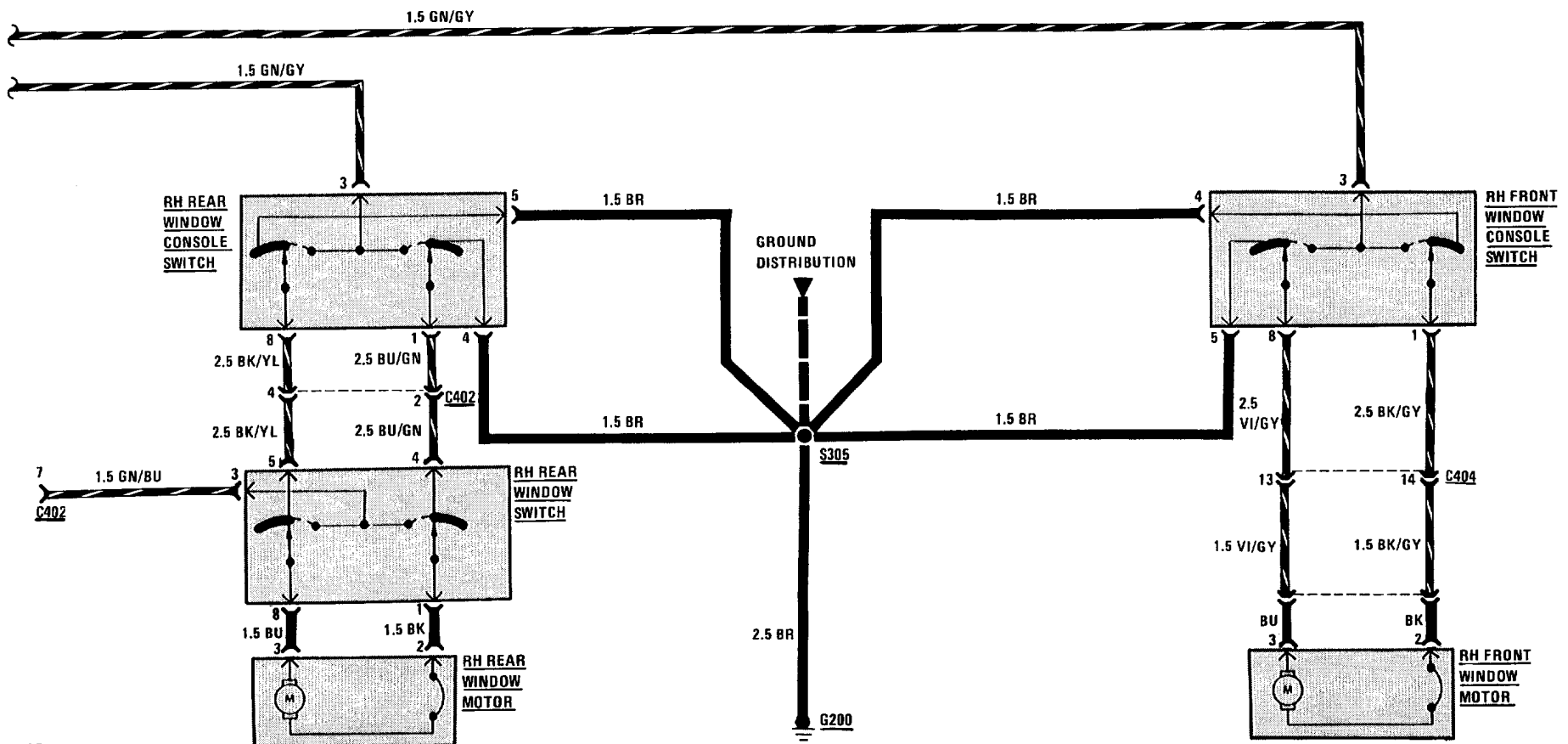

# 5133-2 POWER WINDOWS

## 4 DOOR (LATE PRODUCTION)

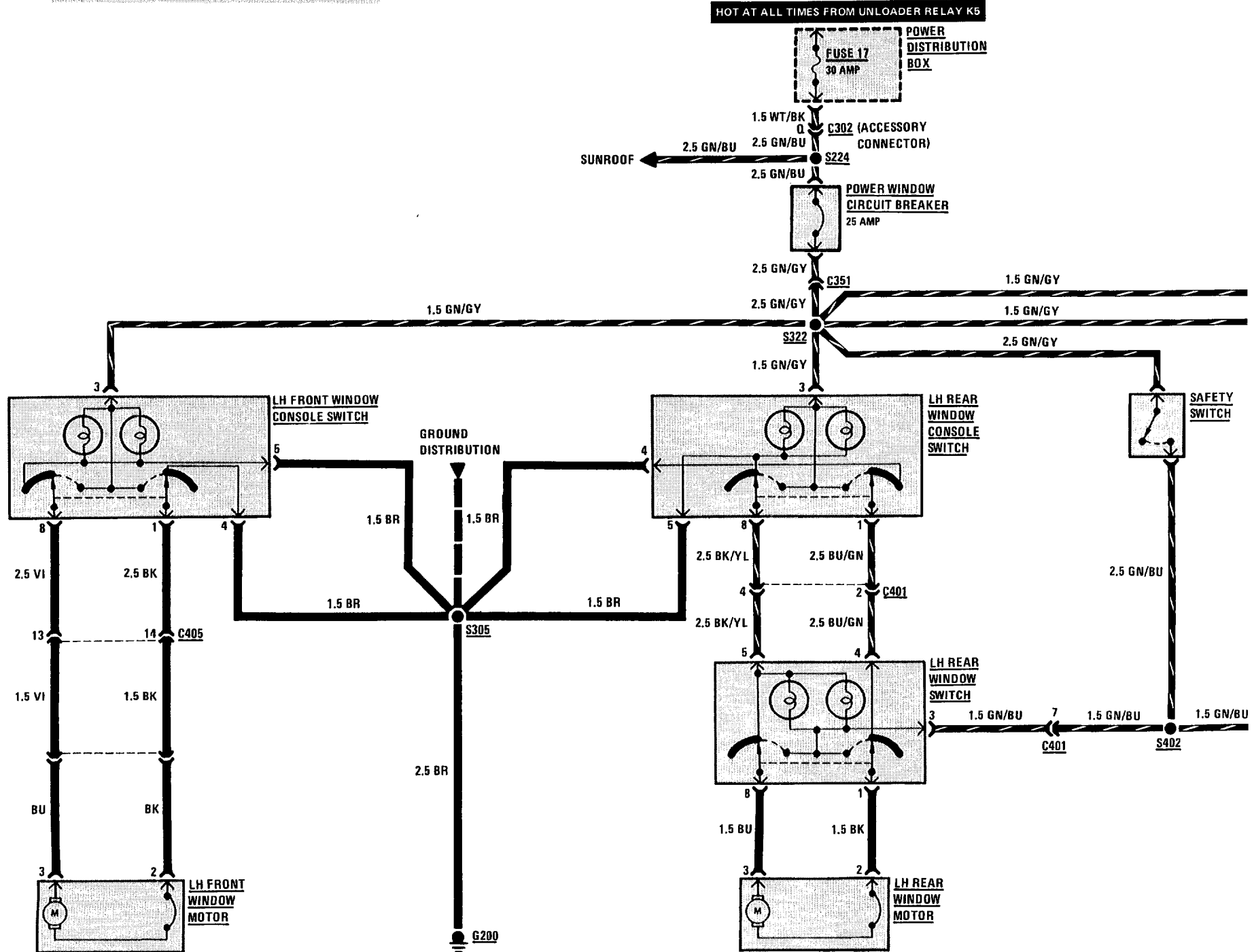

4 DOOR (LATE PRODUCTION)

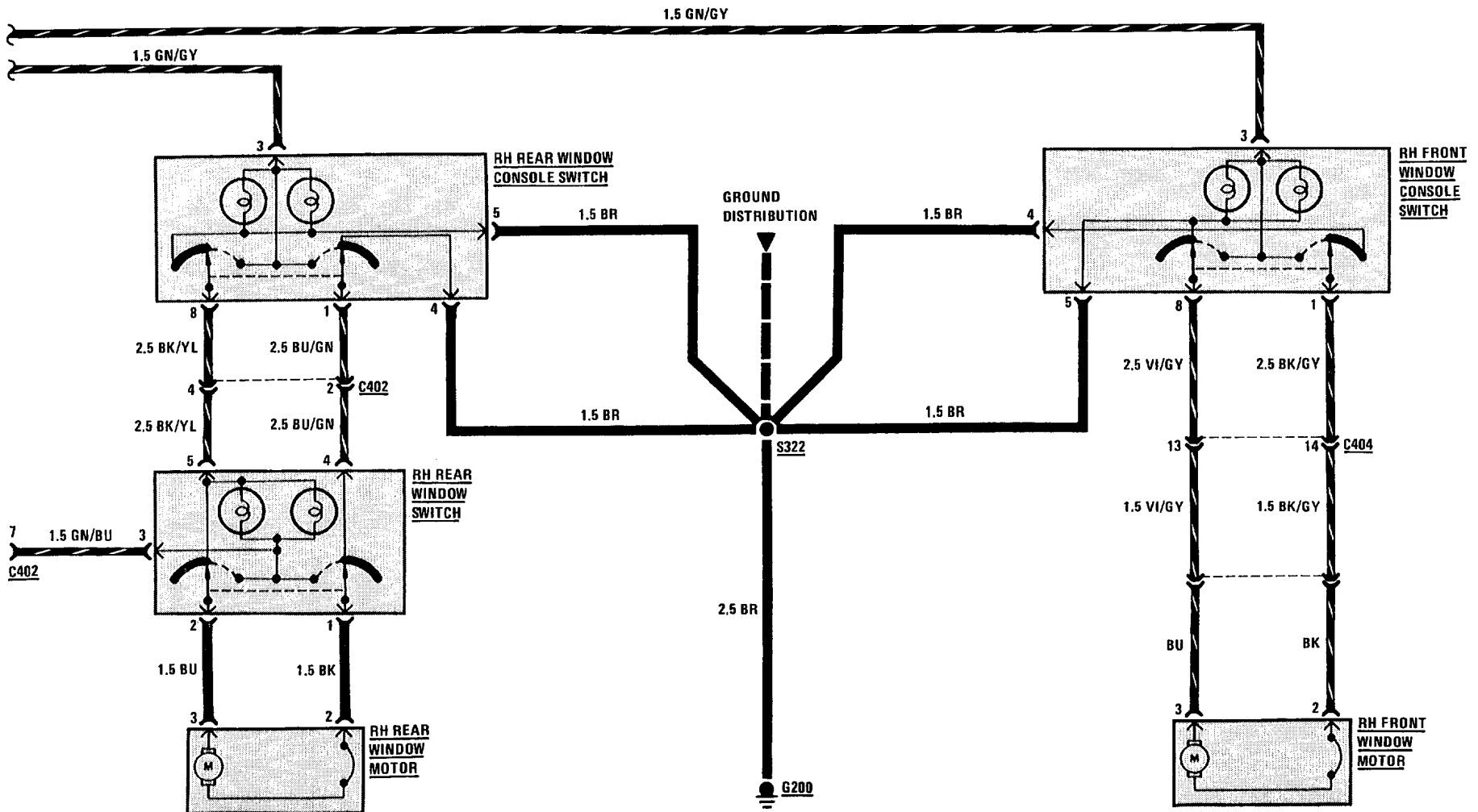



2 DOOR (LATE PRODUCTION)

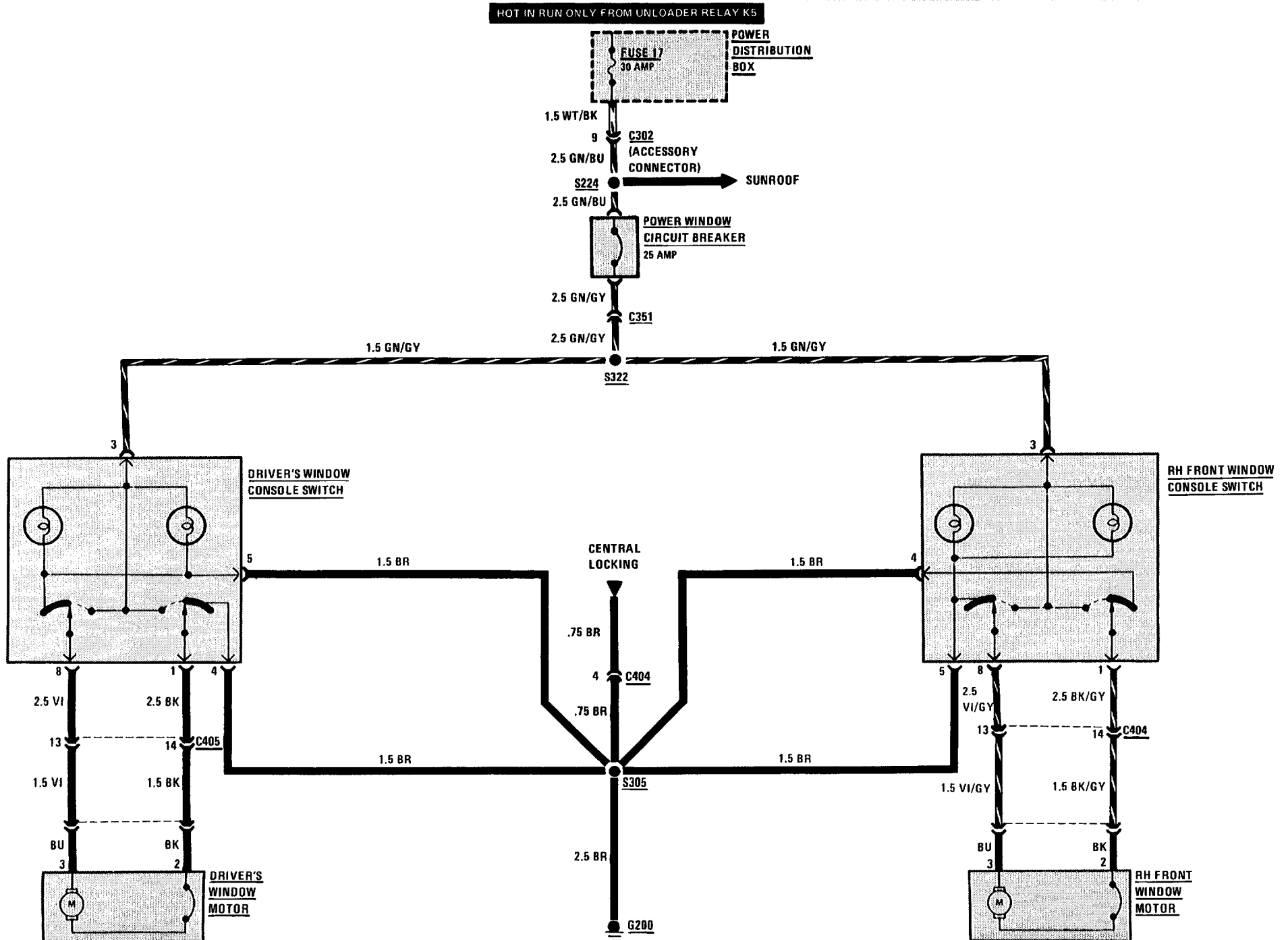

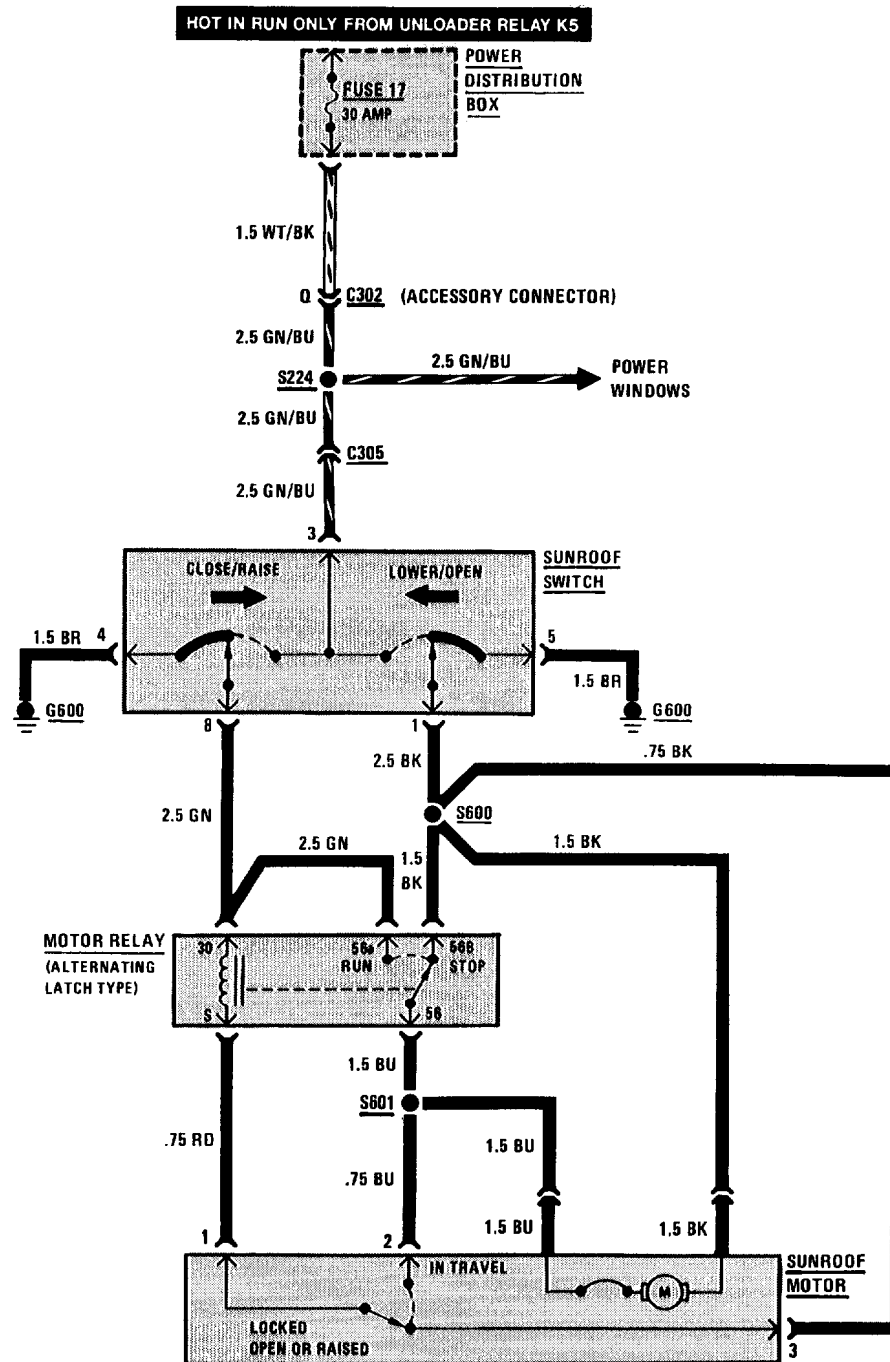

**HORNS**

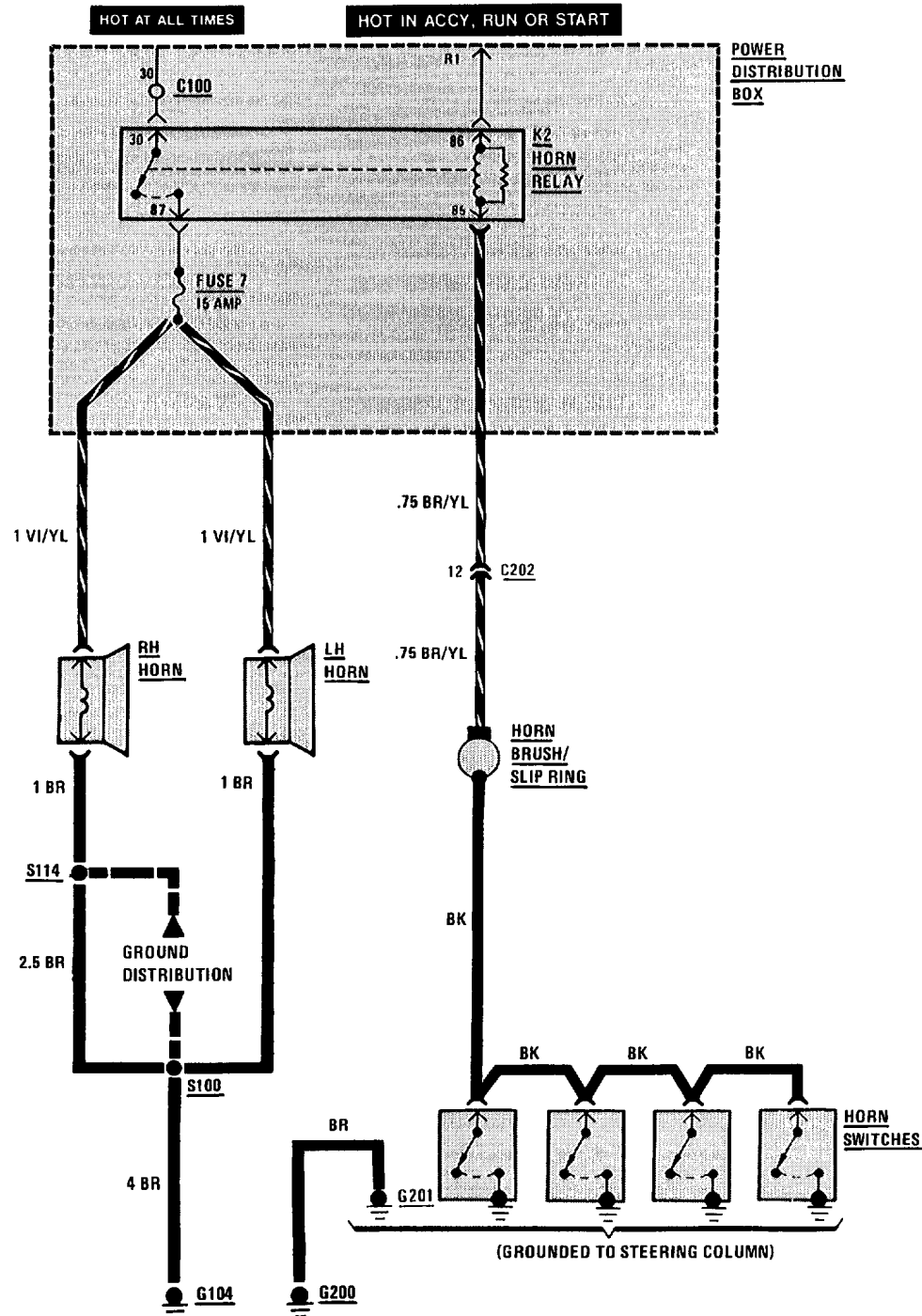



CIGAR LIGHTER/GLOVE BOX LIGHT/AUTO-CHARGING FLASHLIGHT/MAP READING LIGHT

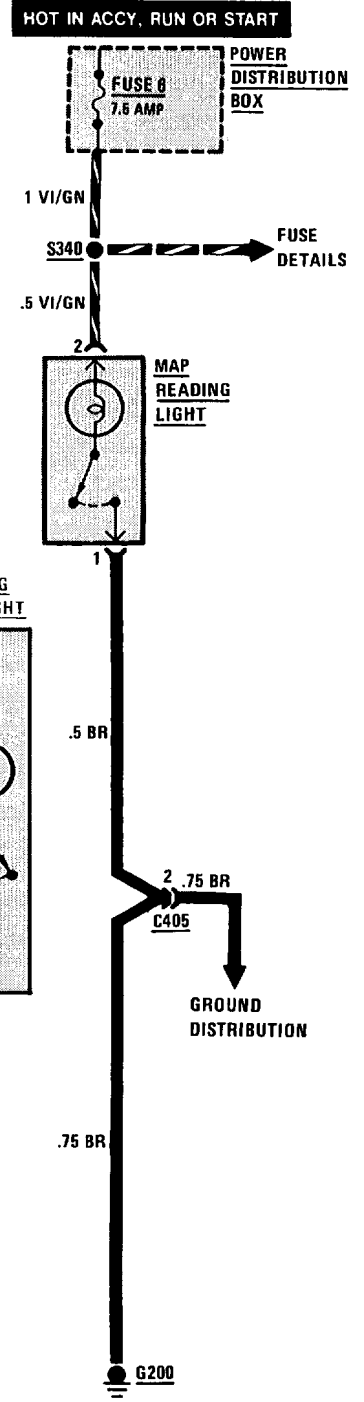
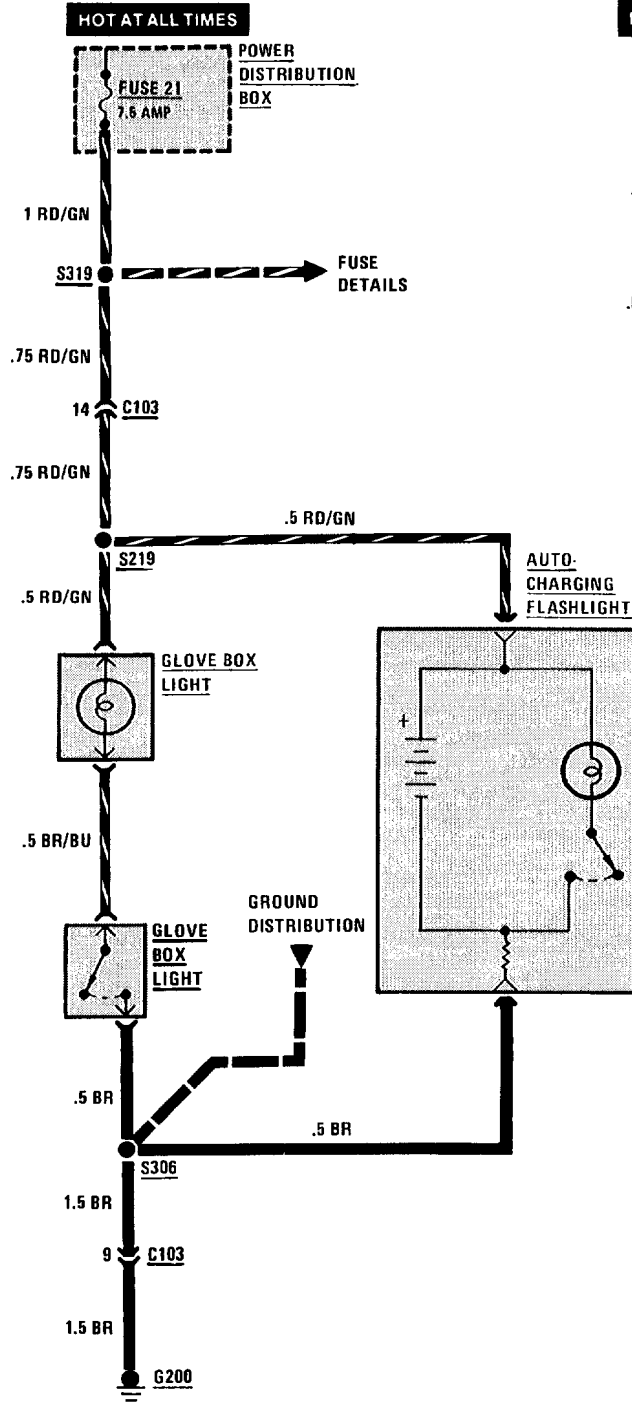
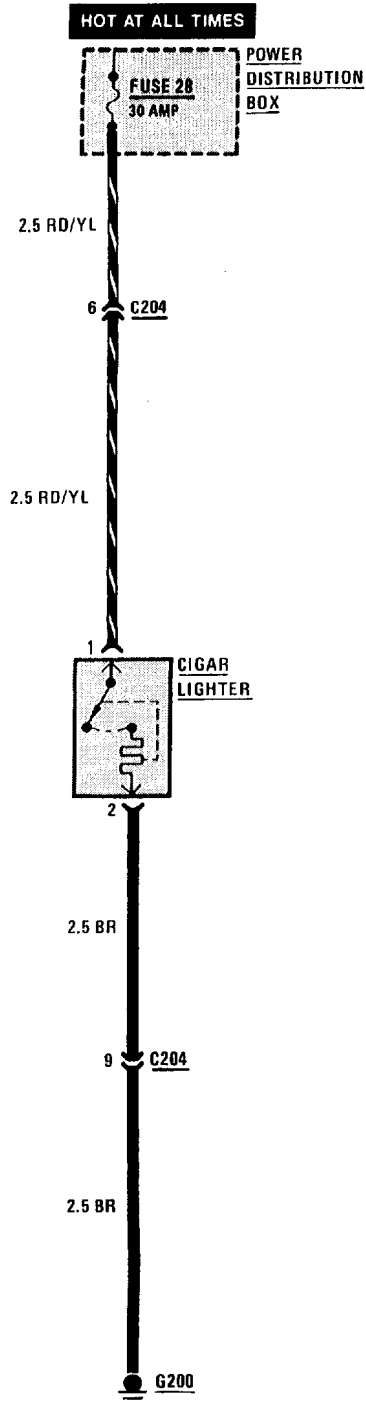

**REAR DEFOGGER**

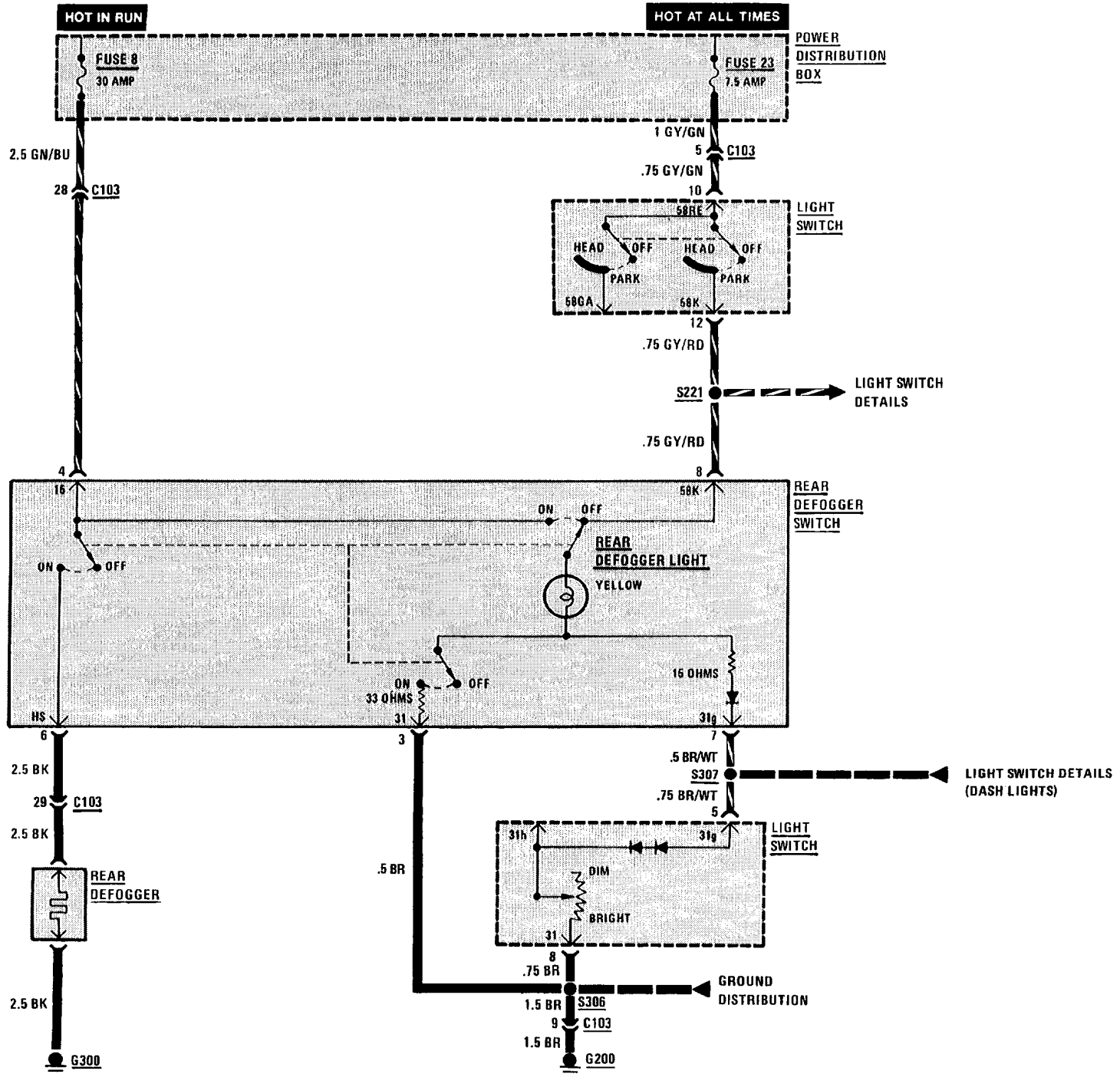

# 6131-0 IGNITION KEY WARNING/SEATBELT WARNING

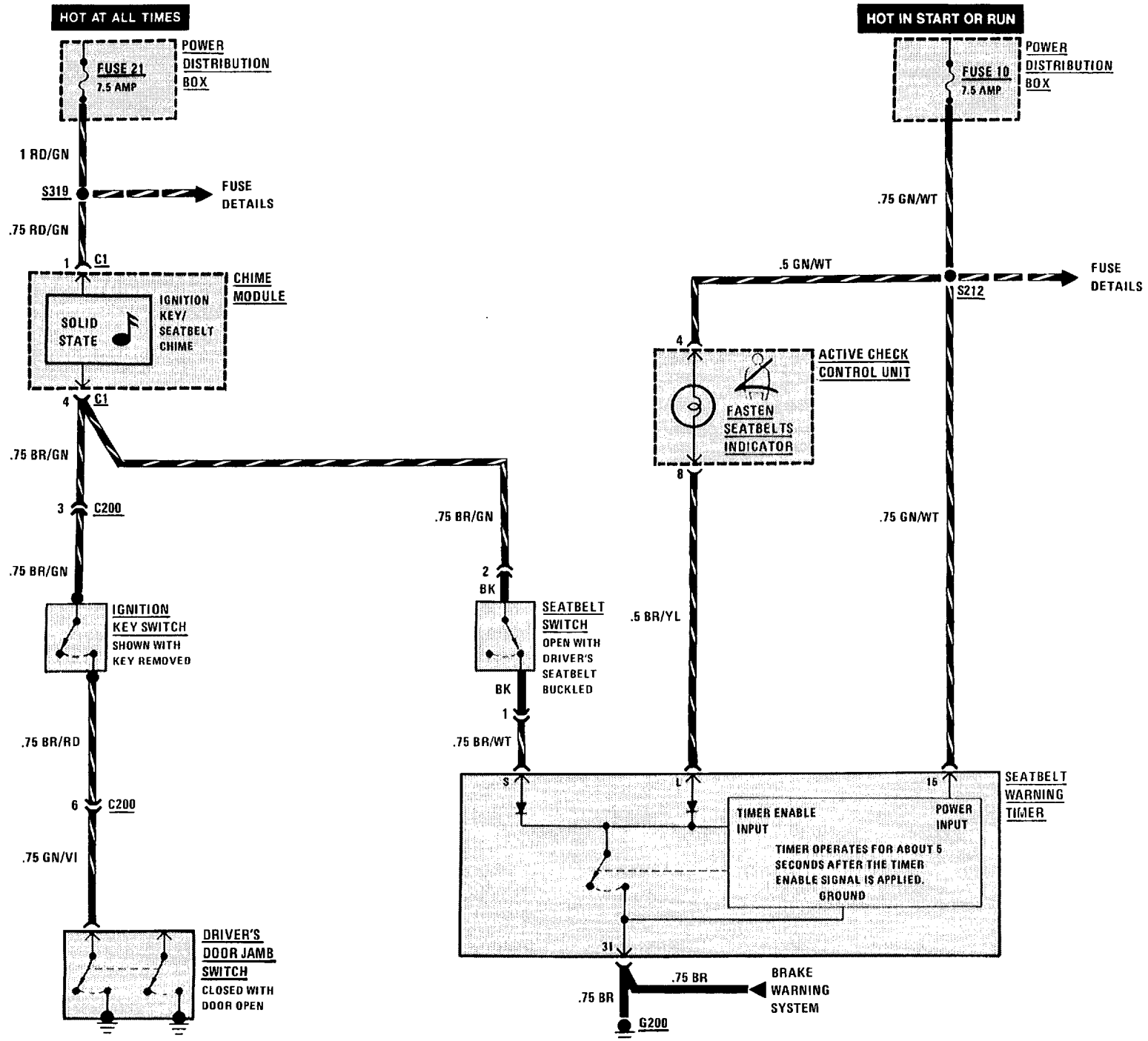

# 6160-0 WIPER/WASHER

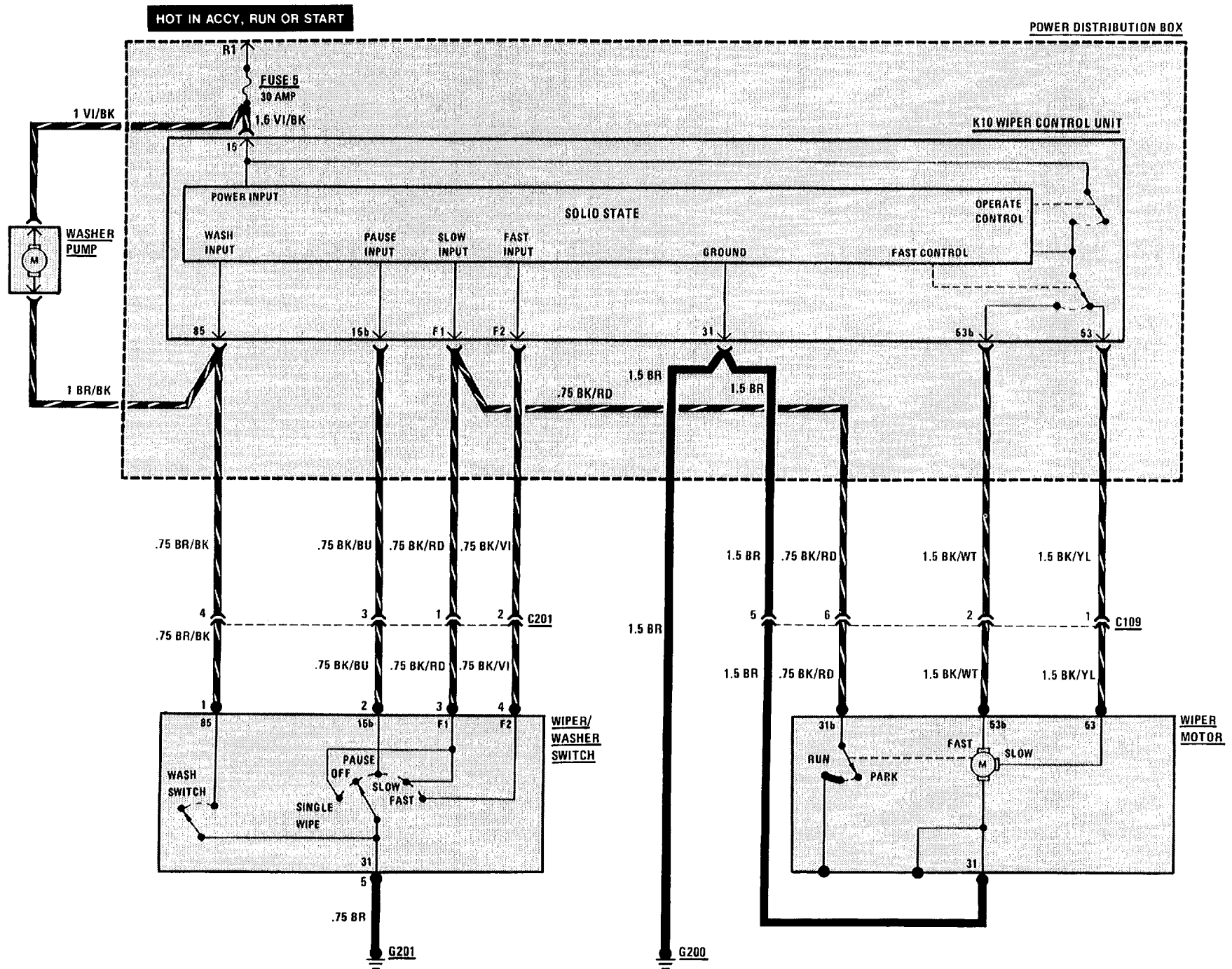

# 6210-0 INSTRUMENT CLUSTER

## SPEEDOMETER/INDICATORS EARLY PRODUCTION

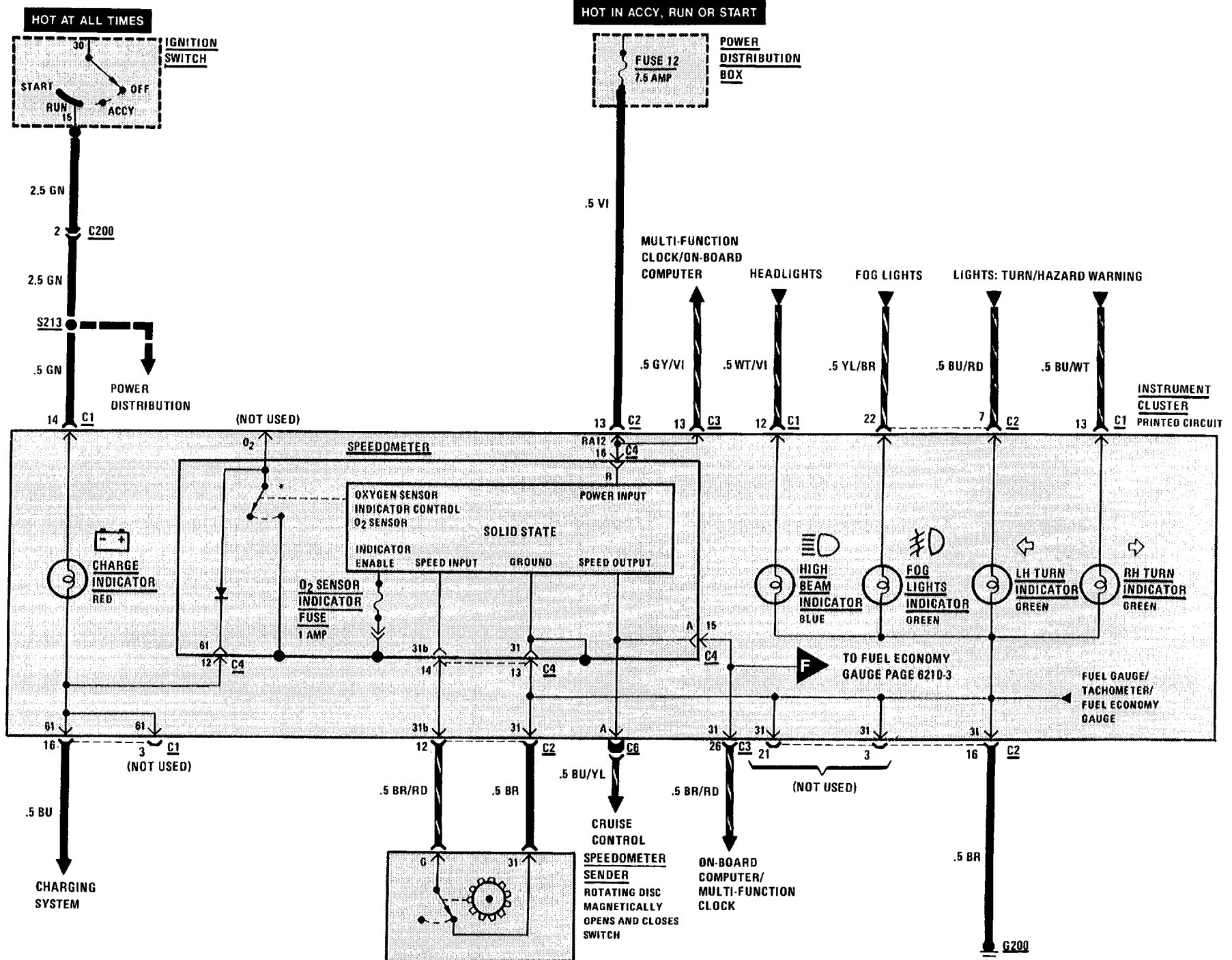

SERVICE INTERVAL INDICATOR EARLY PRODUCTION

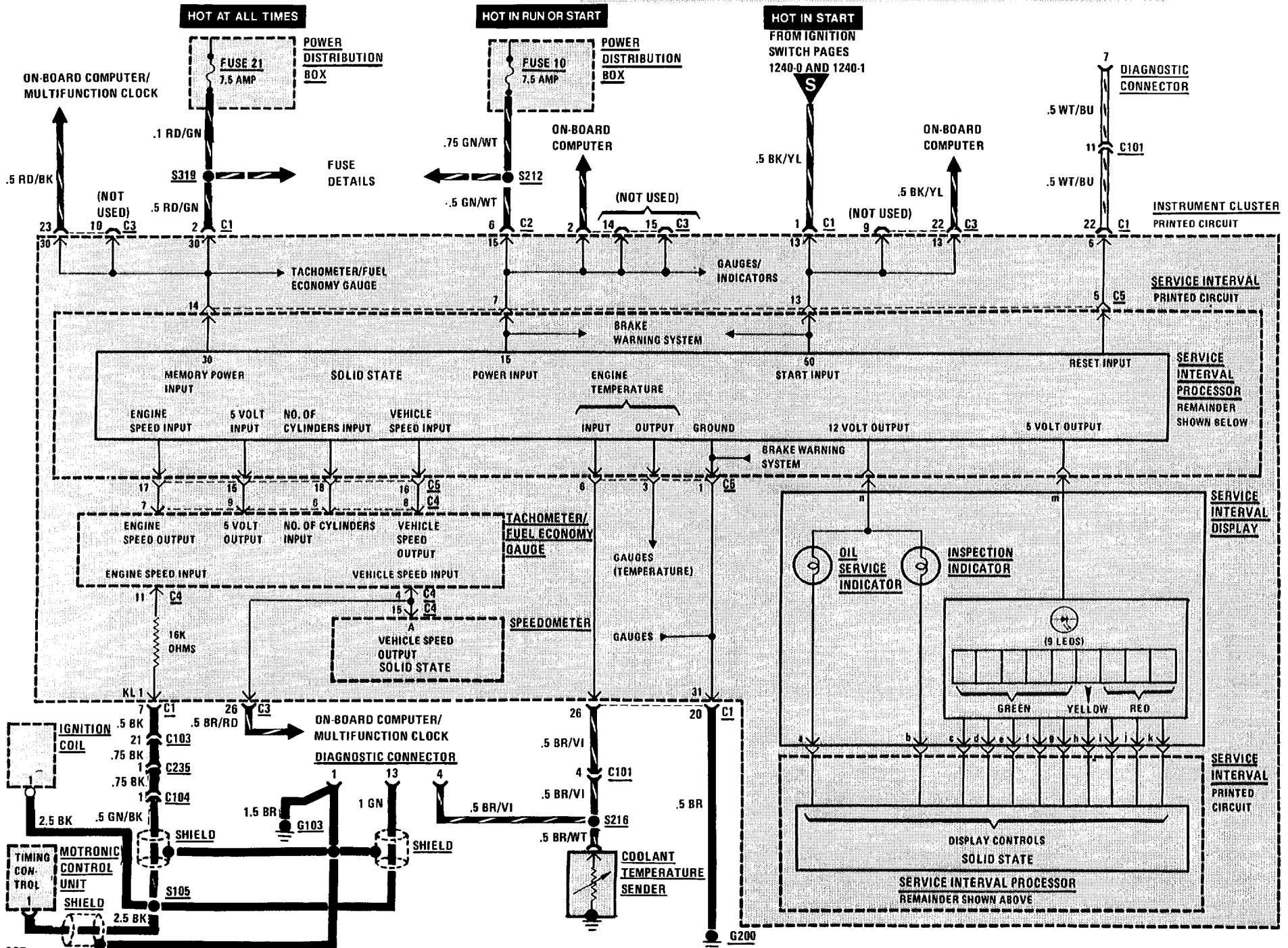



TACHOMETER/FUEL ECONOMY GAUGE EARLY PRODUCTION

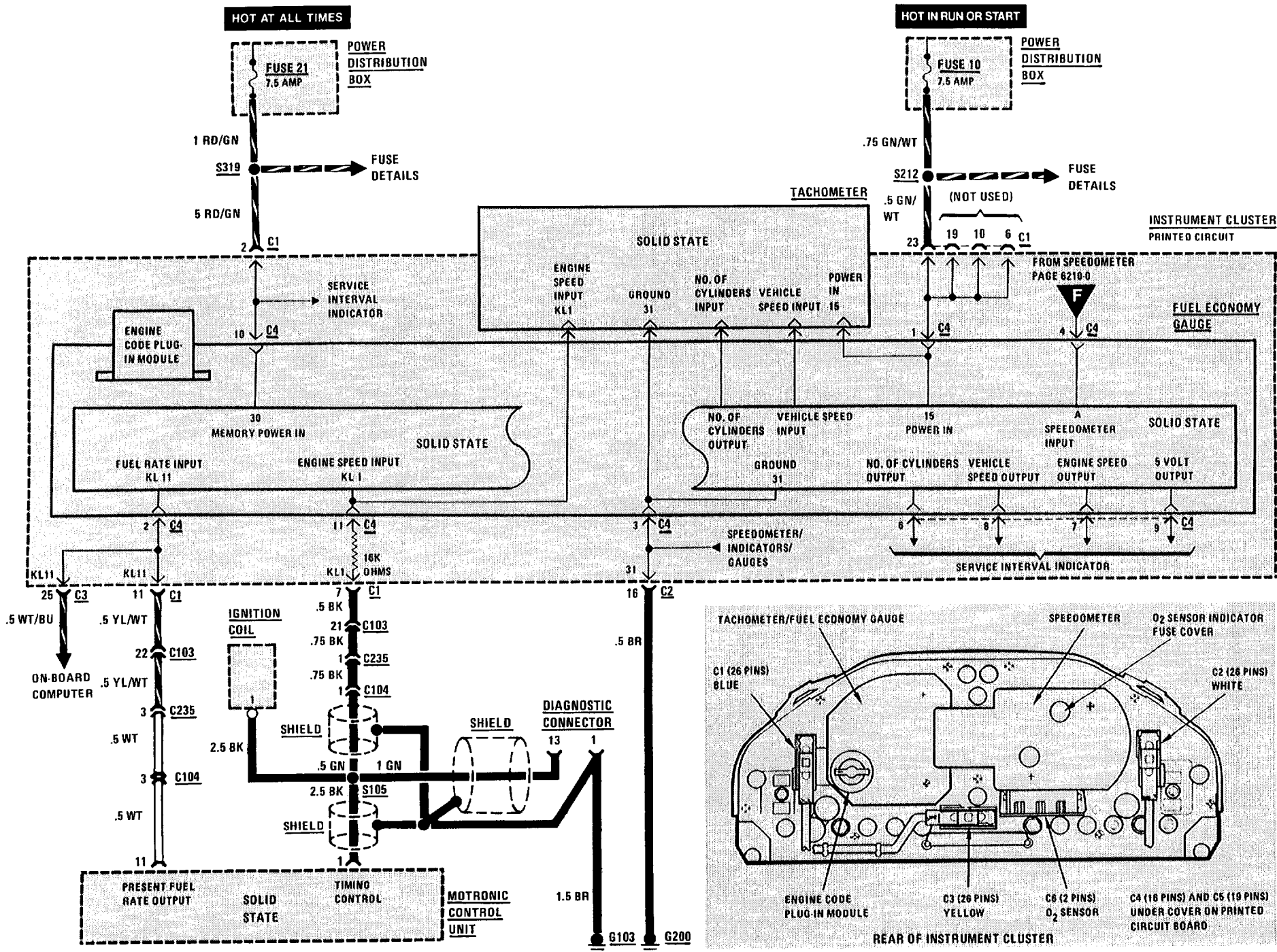





SERVICE INTERVAL INDICATOR LATE PRODUCTION

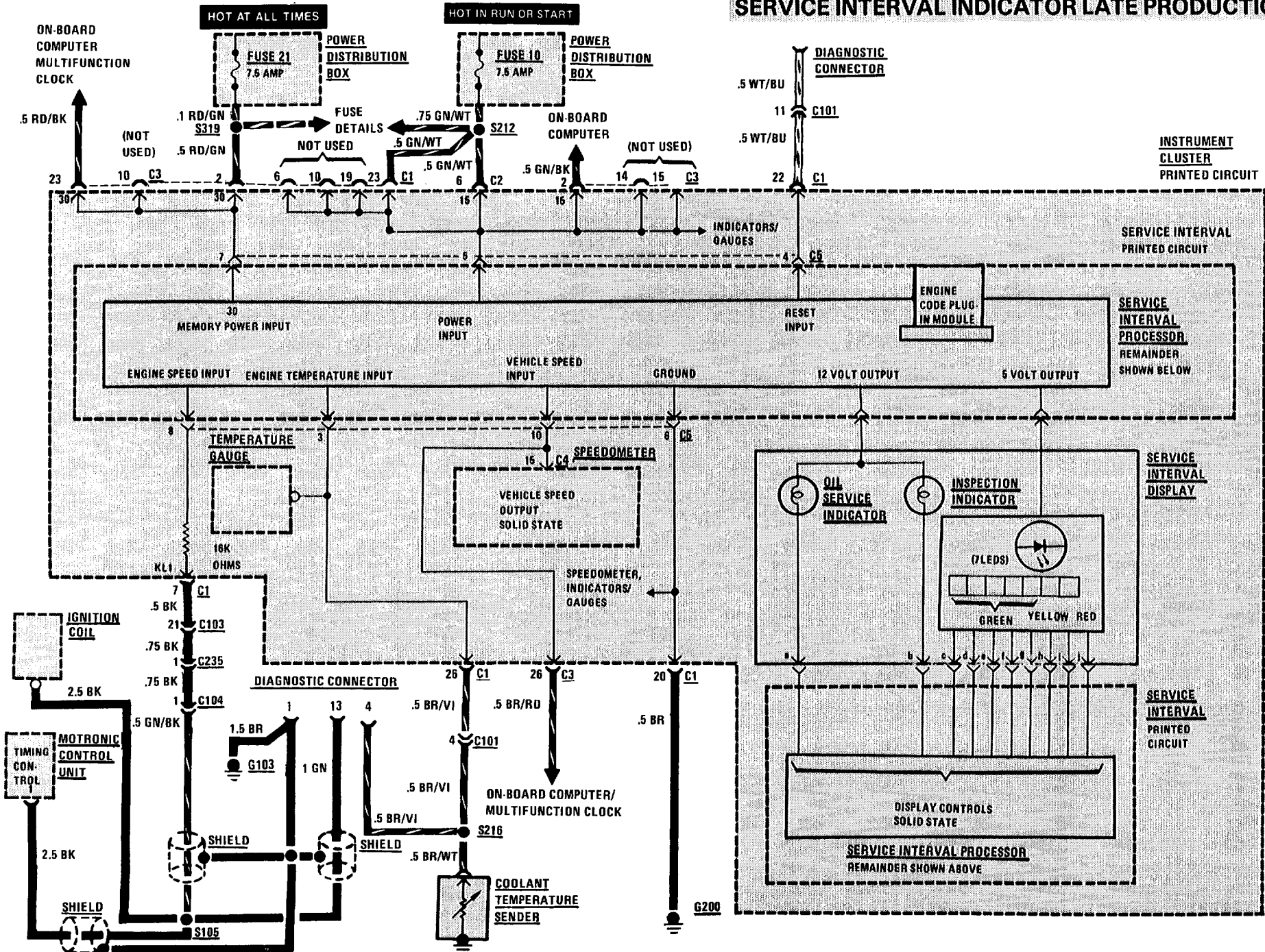

# 6210-6 INSTRUMENT CLUSTER

## GAUGES/INDICATORS LATE PRODUCTION

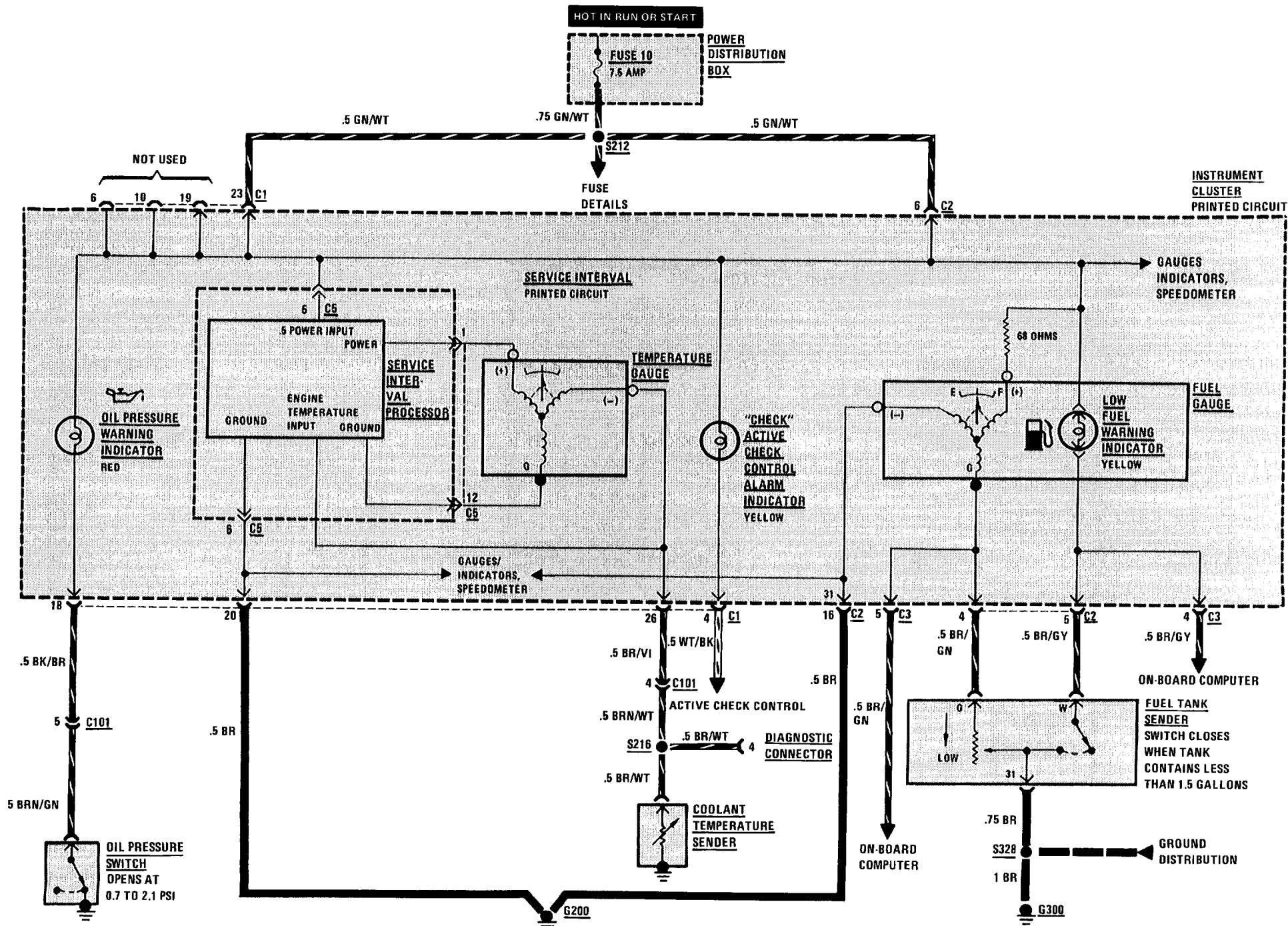

TACHOMETER/FUEL ECONOMY GAUGE LATE PRODUCTION

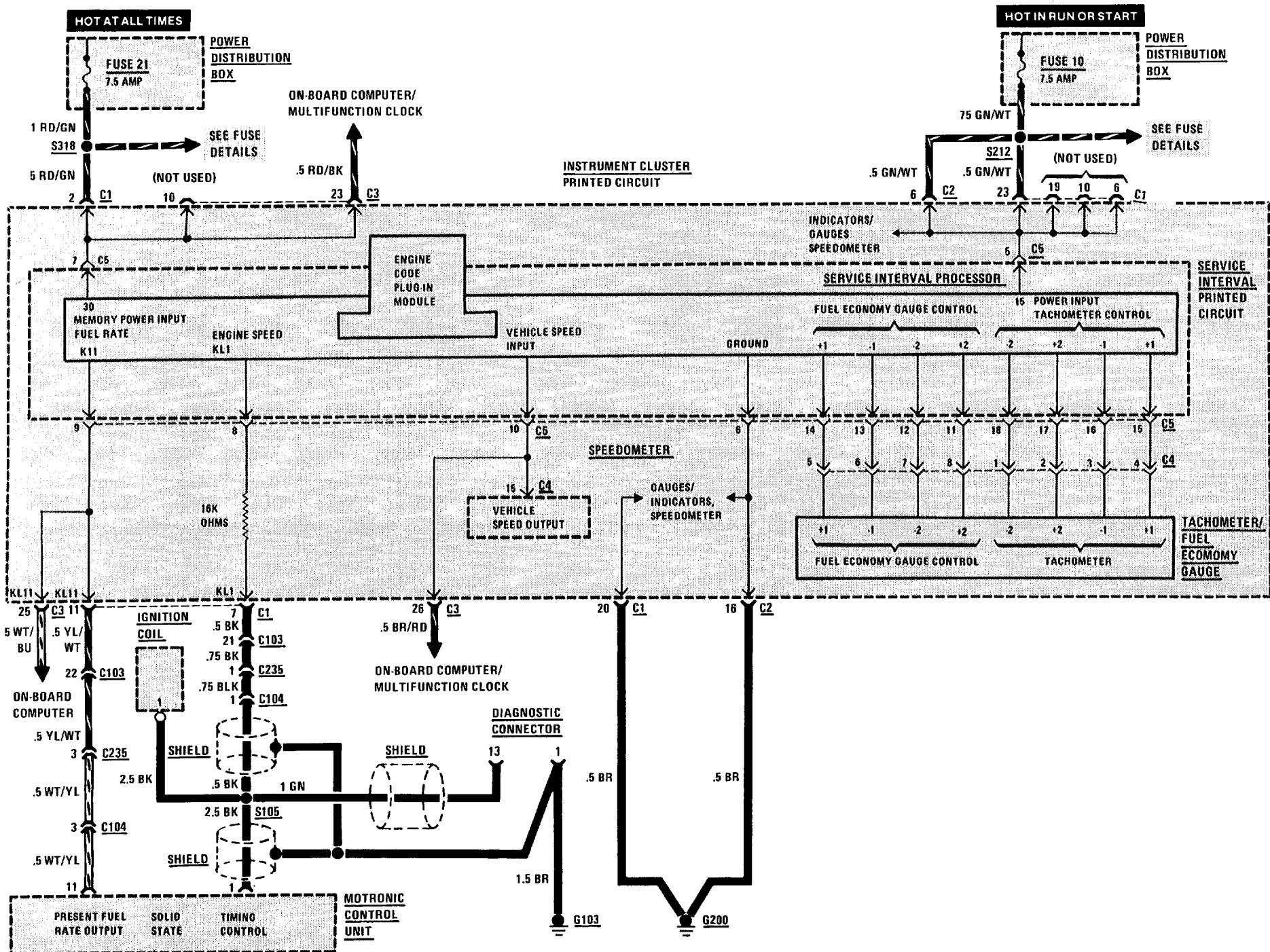

## ACTIVE CHECK CONTROL

1. When the Ignition Switch is initially placed in "Run," the Active Check Control Arm Indicator flashes, and the Active Check Control Unit Brake Light LED and panel light illuminate for test purposes. Depressing the brake pedal clears the display.
2. When the Ignition Switch is placed in "Run," fault monitoring begins. To monitor the low beams, rear lights, or license lights, those circuits must be on. The brake lights are monitored only while the brake pedal is depressed.
3. When a fault occurs, the alarm indicator flashes, the appropriate LED fault indicator lights, and the panel light goes on for five seconds. Depressing the test button will clear the alarm indicator, but the LED fault indicator remains on.
4. To test the unit, depress the test button. The LED fault indicators and the panel lights should go on.

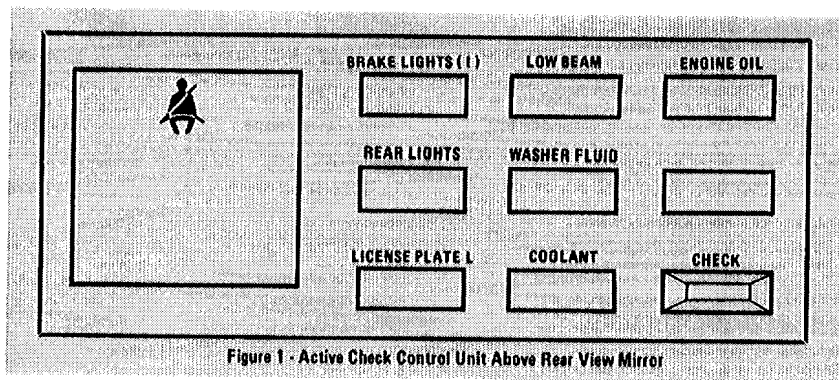
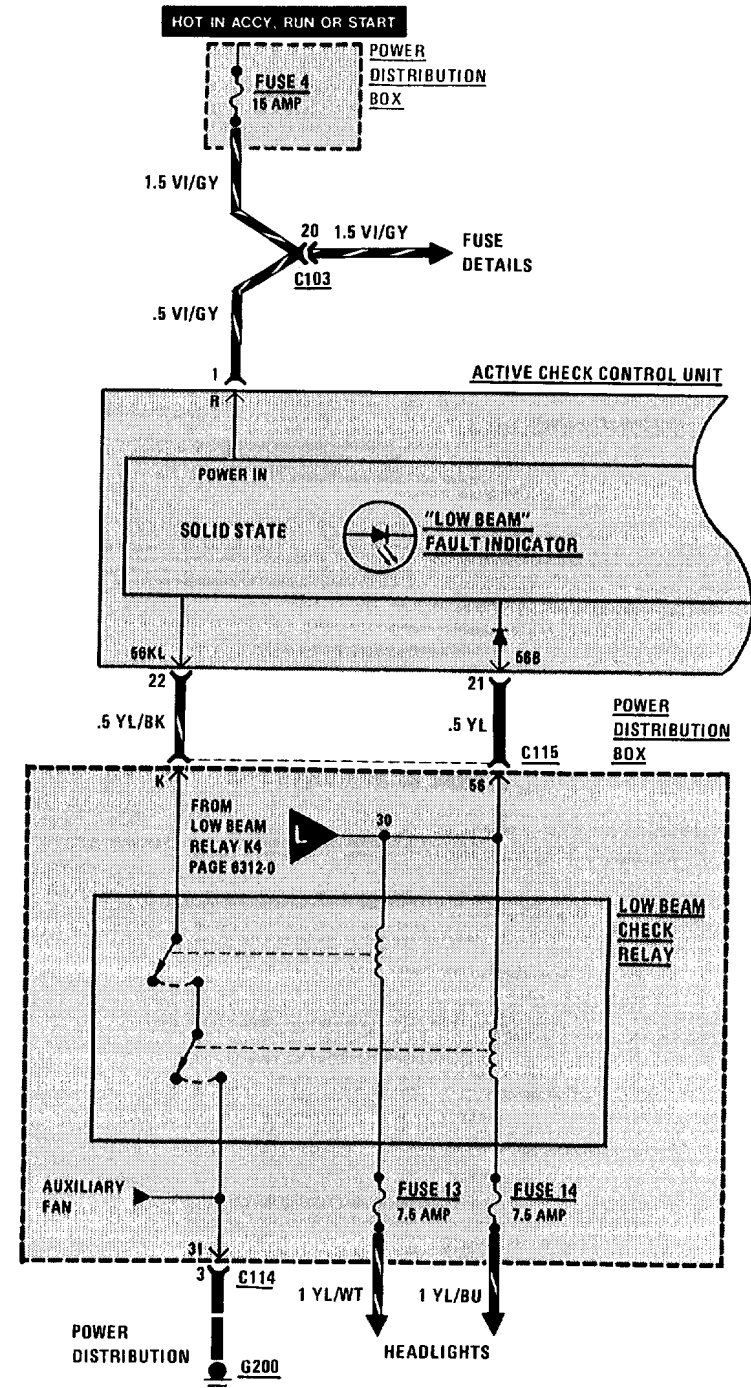
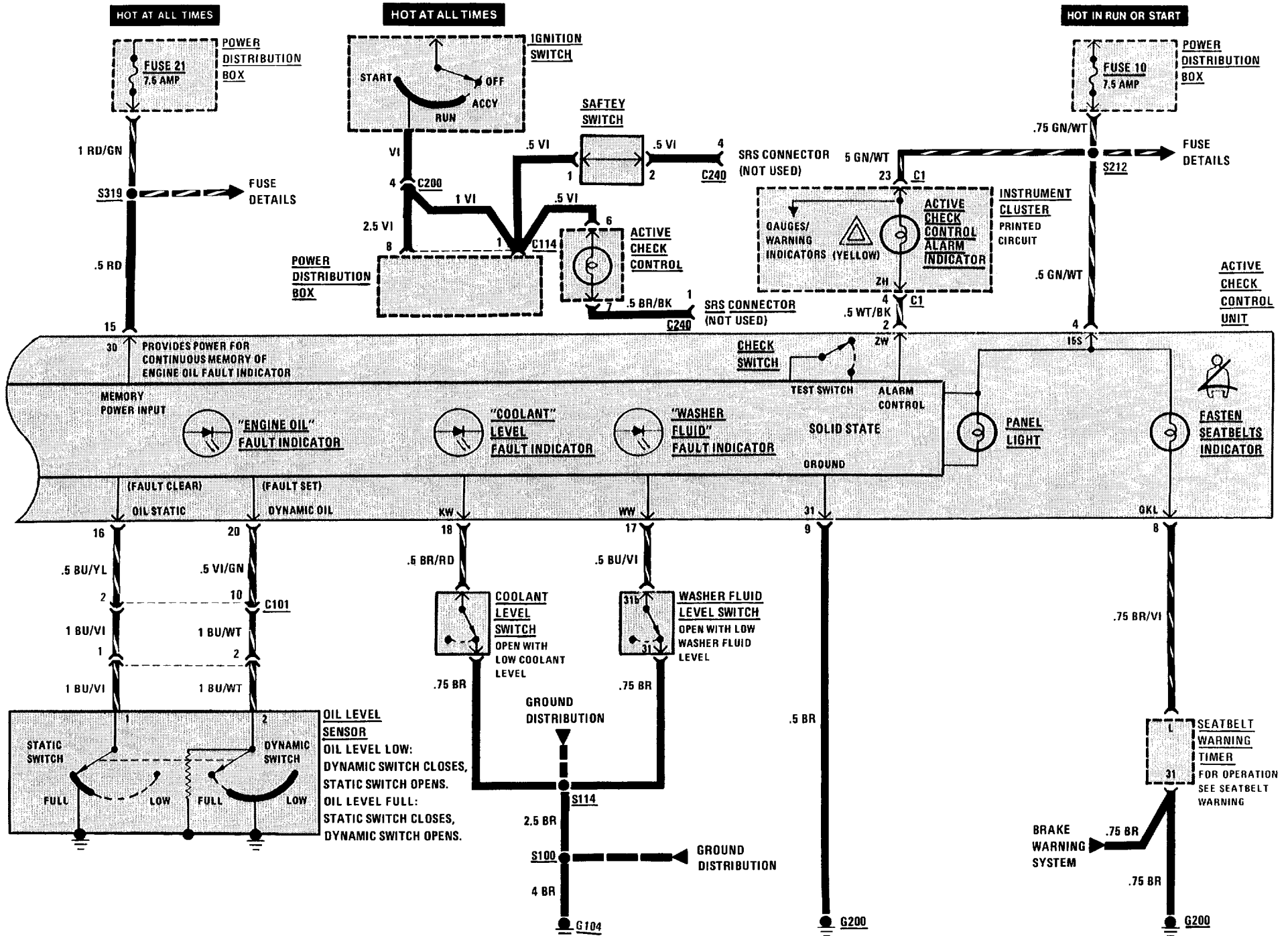

Figure 1 - Active Check Control Unit Above Rear View Mirror





# 6216-2 ACTIVE CHECK CONTROL



# 6300-0 LIGHT SWITCH DETAILS

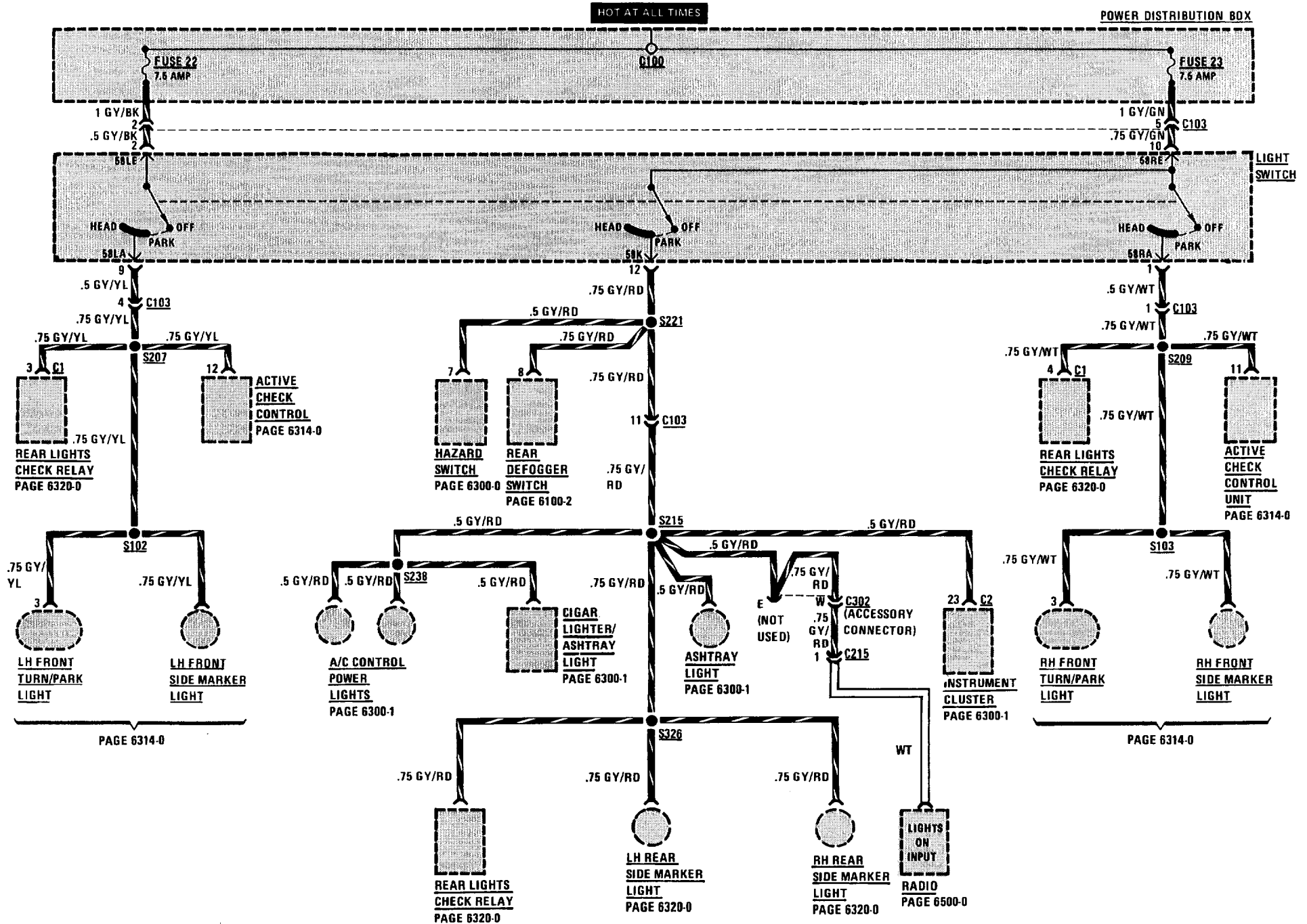



DASH LIGHTS

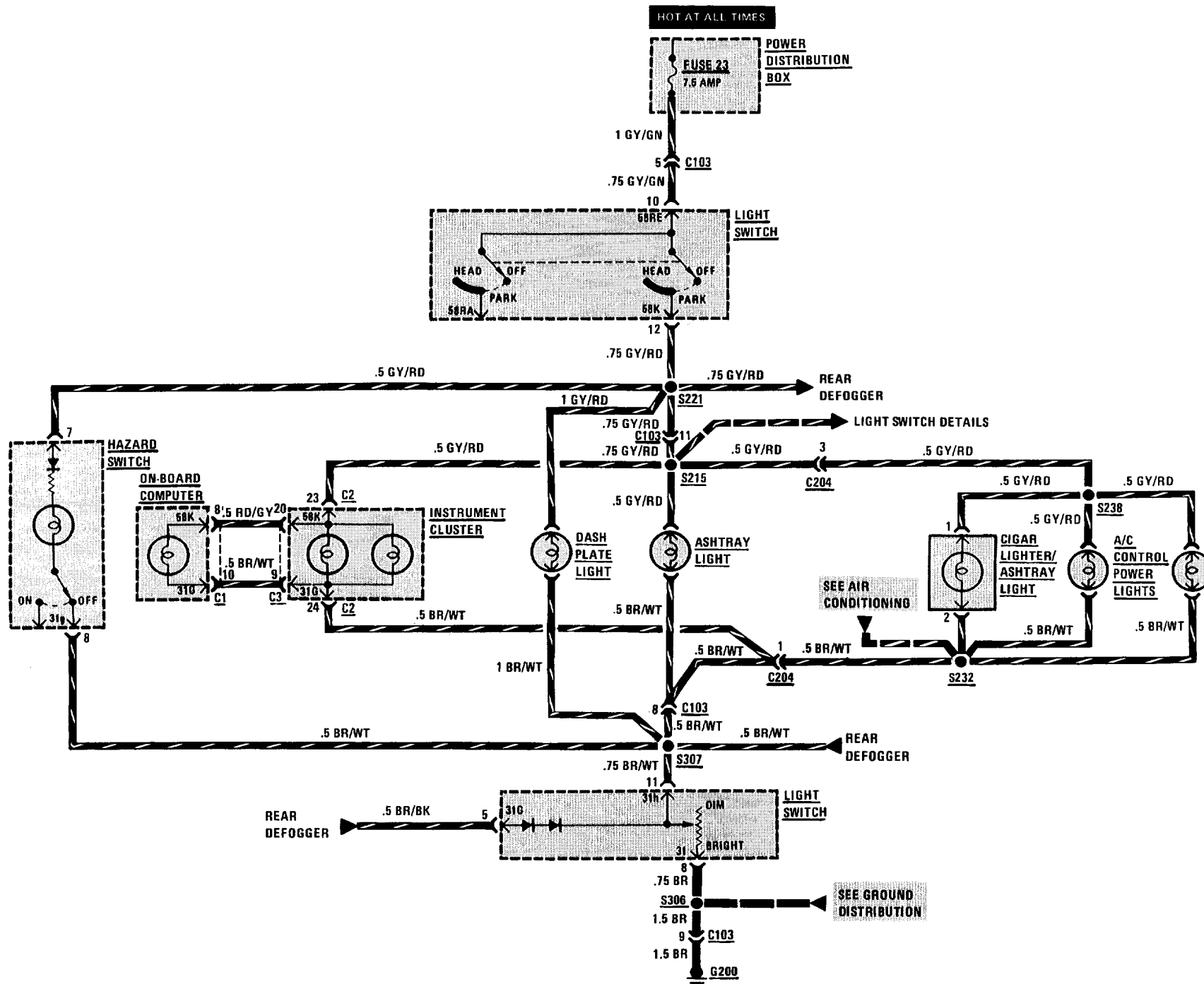

# 6312-0 HEADLIGHTS/FOGLIGHTS

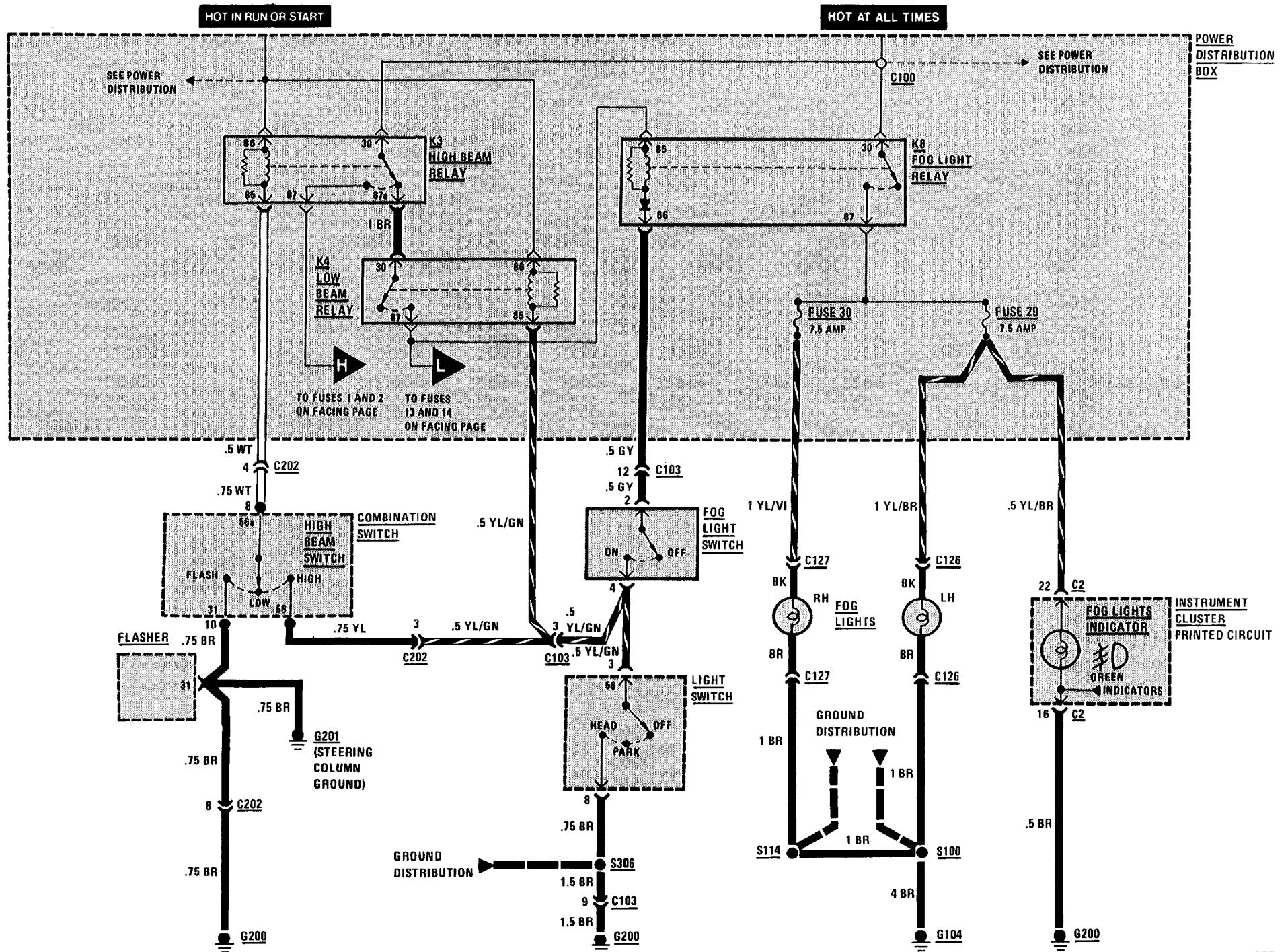

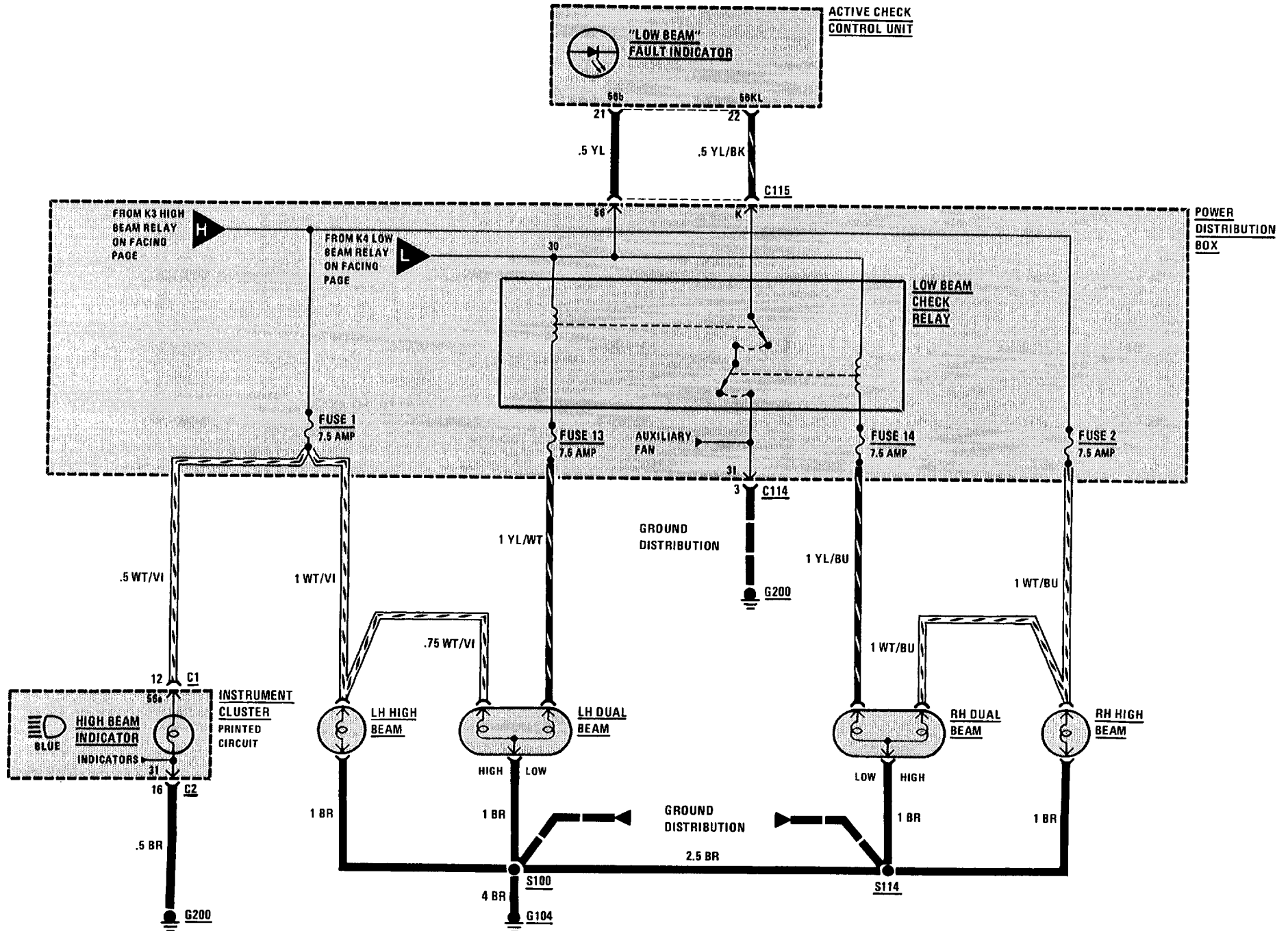

# 6313-0 TURN/HAZARD LIGHTS

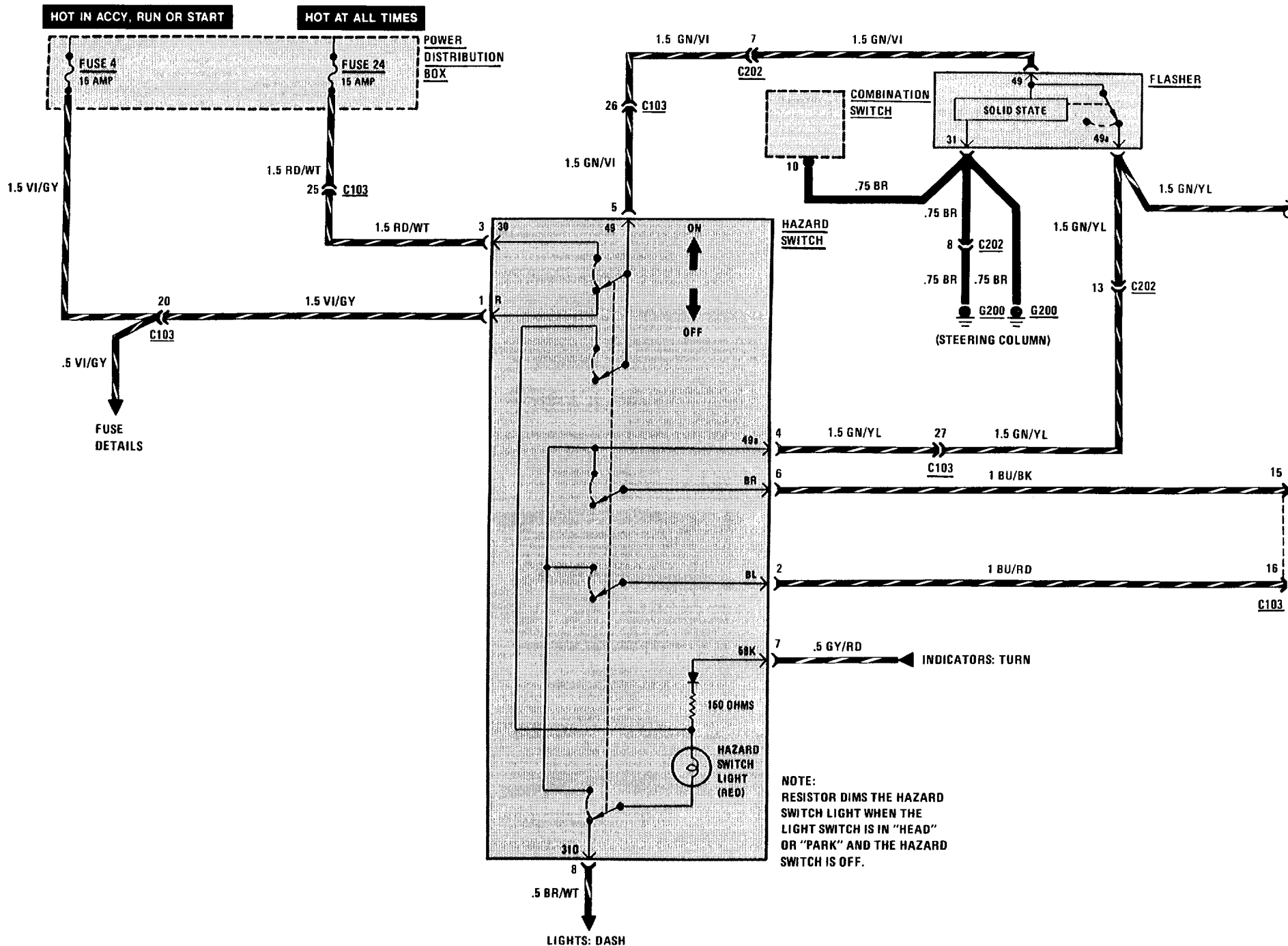

**NOTE:**  
RESISTOR DIMS THE HAZARD SWITCH LIGHT WHEN THE LIGHT SWITCH IS IN "HEAD" OR "PARK" AND THE HAZARD SWITCH IS OFF.

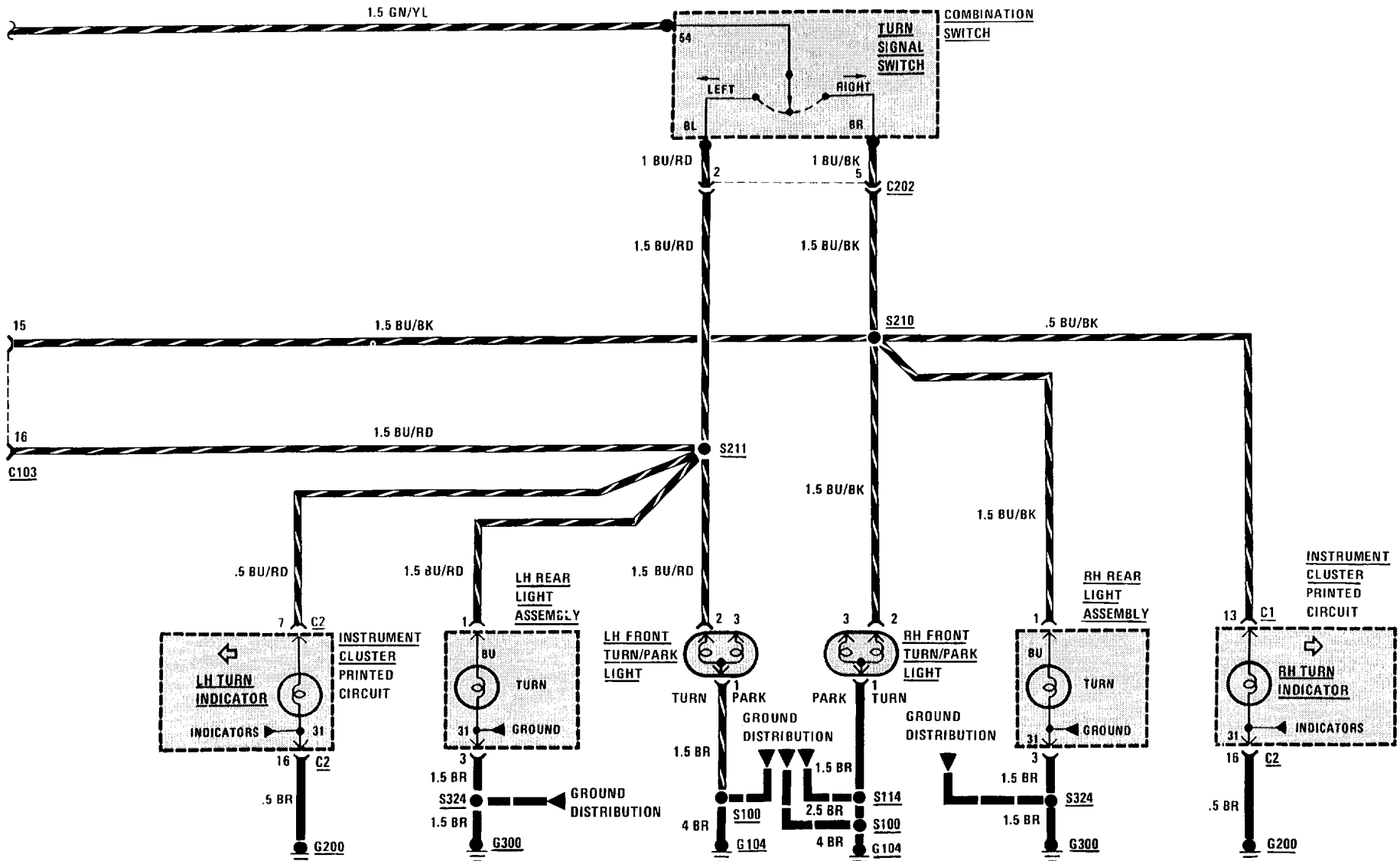

# 6314-0 PARK/TAIL/FRONT MARKER LIGHTS

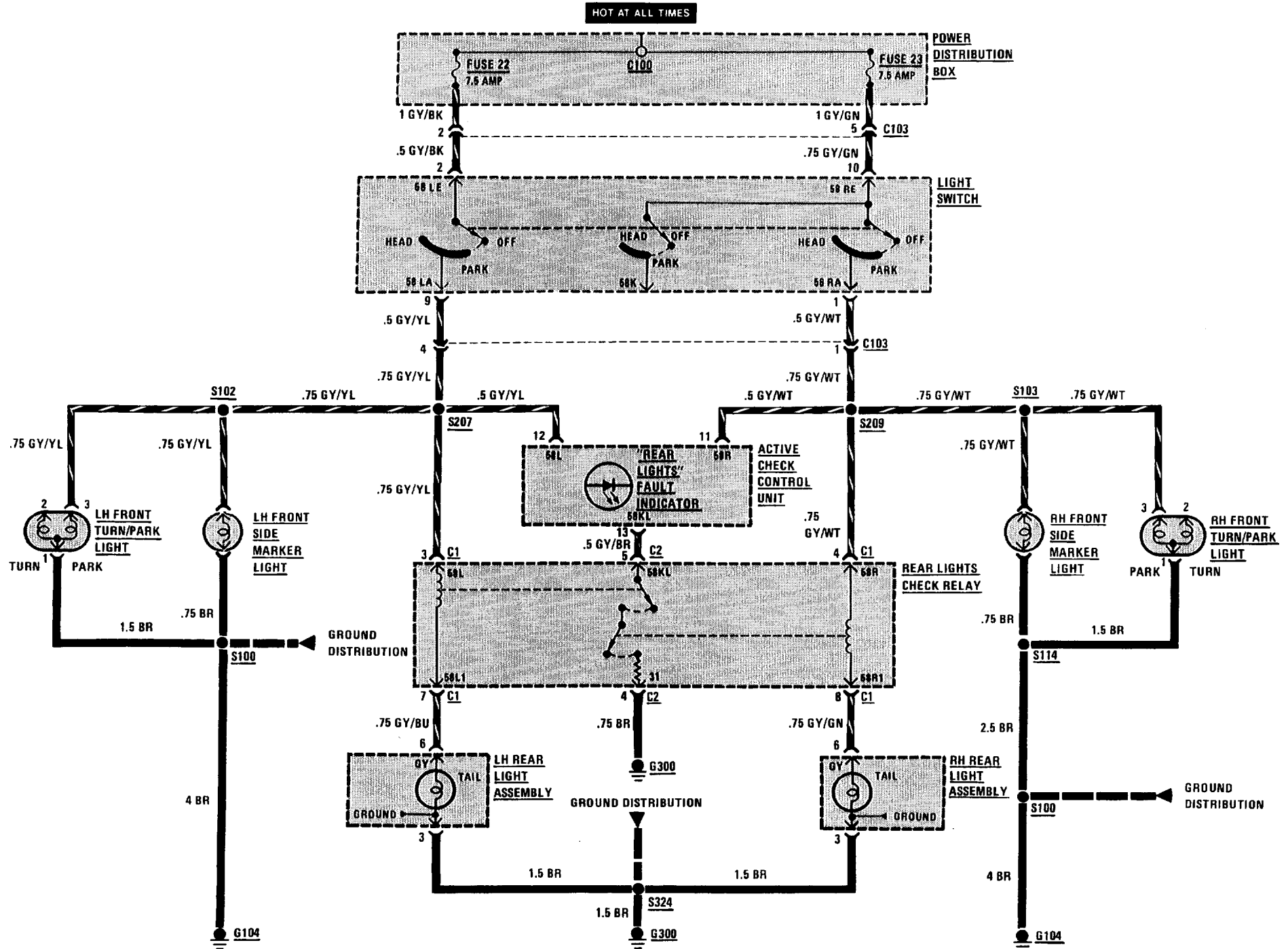

# 6320-0 REAR MARKER/LICENSE/TRUNK LIGHTS

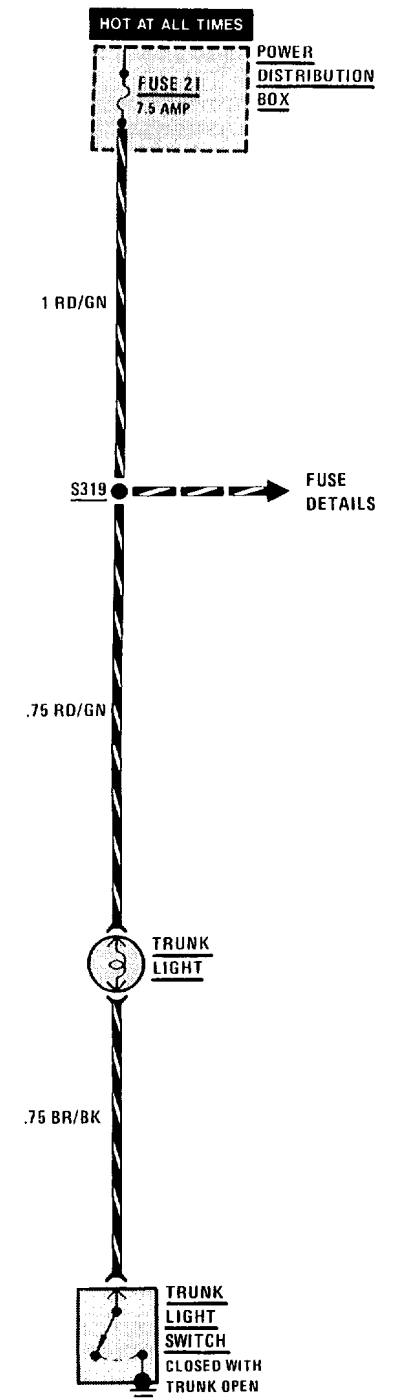
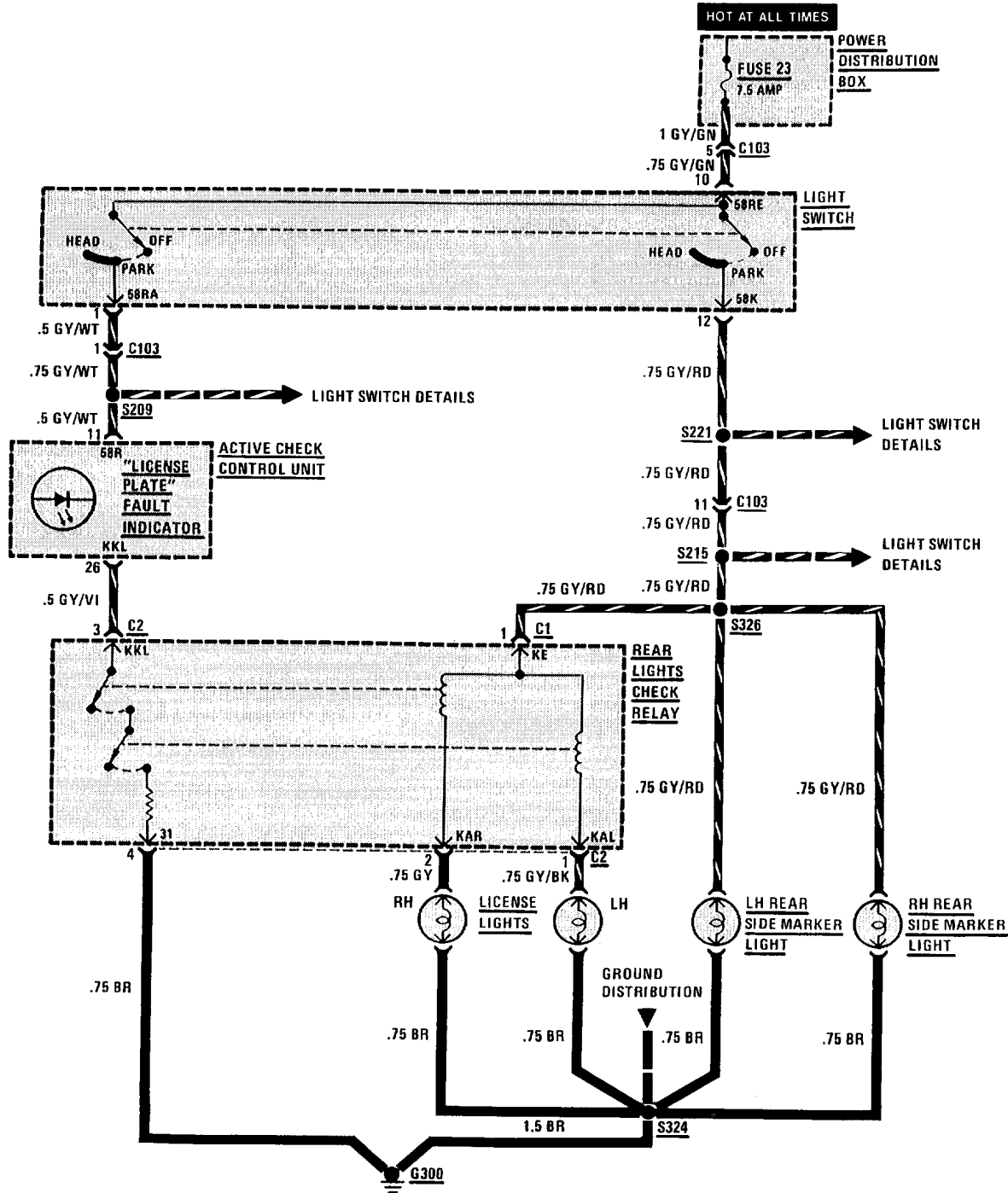

# 6322-0 BACK UP LIGHTS

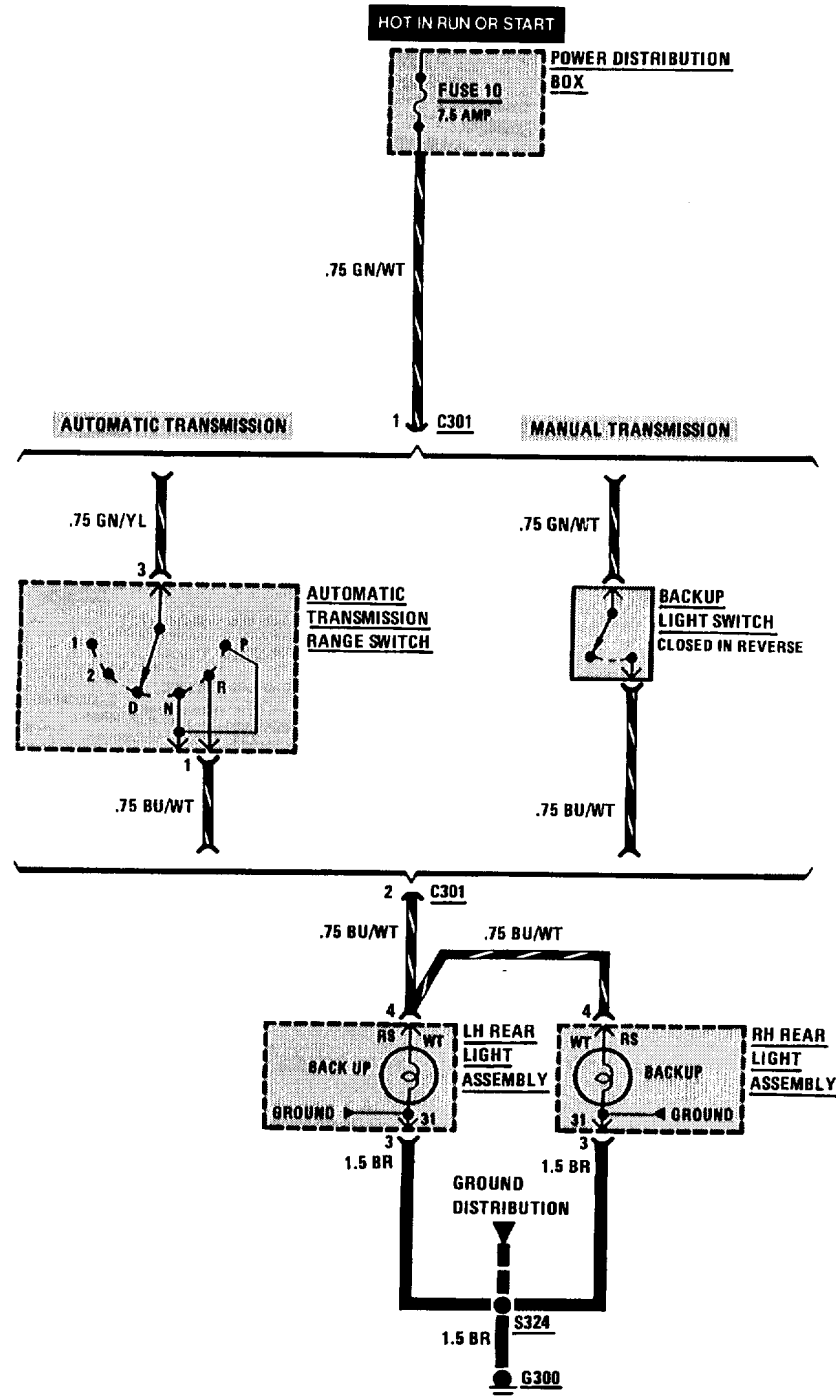



# 6325-0 STOP LIGHTS

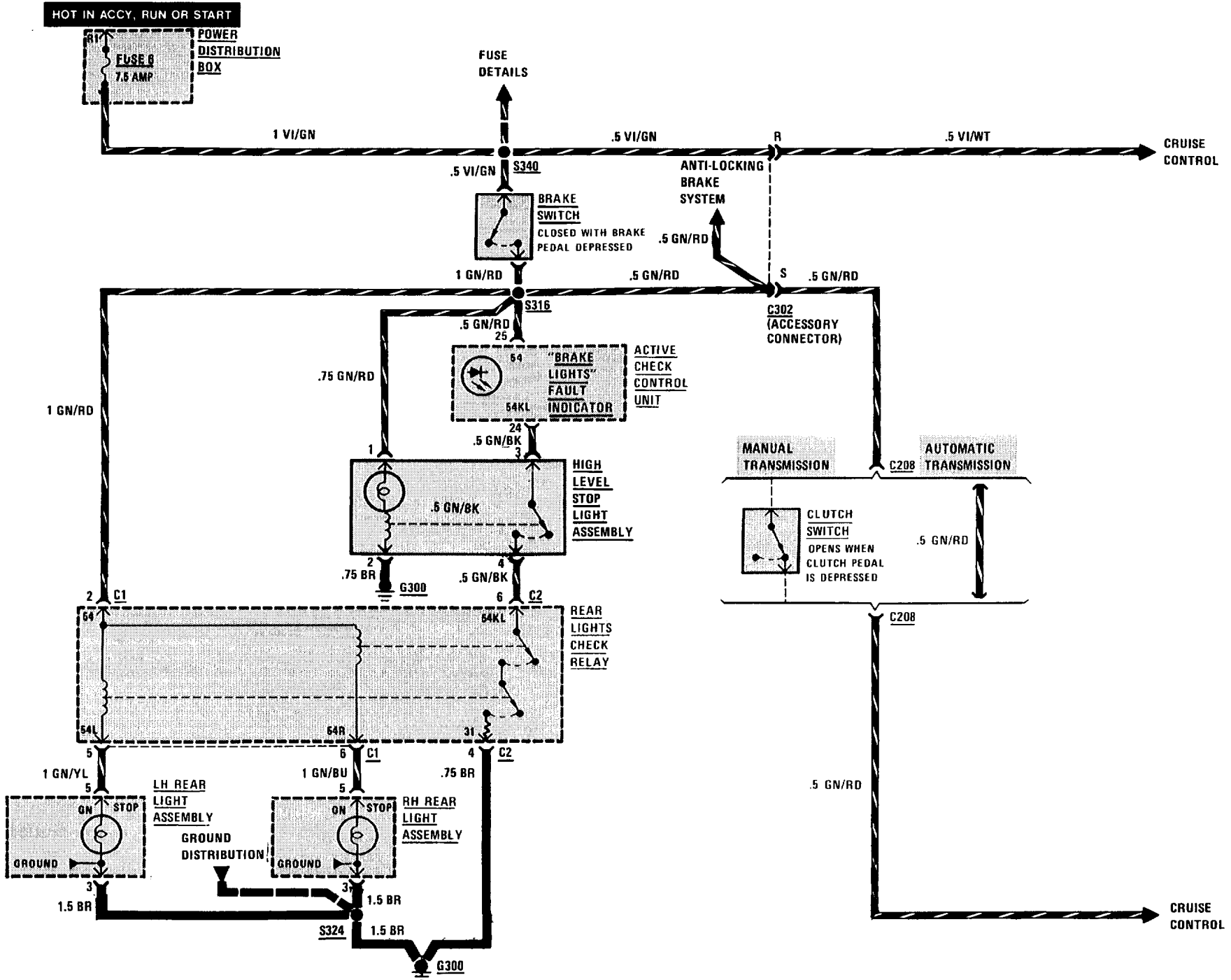

2 DOOR

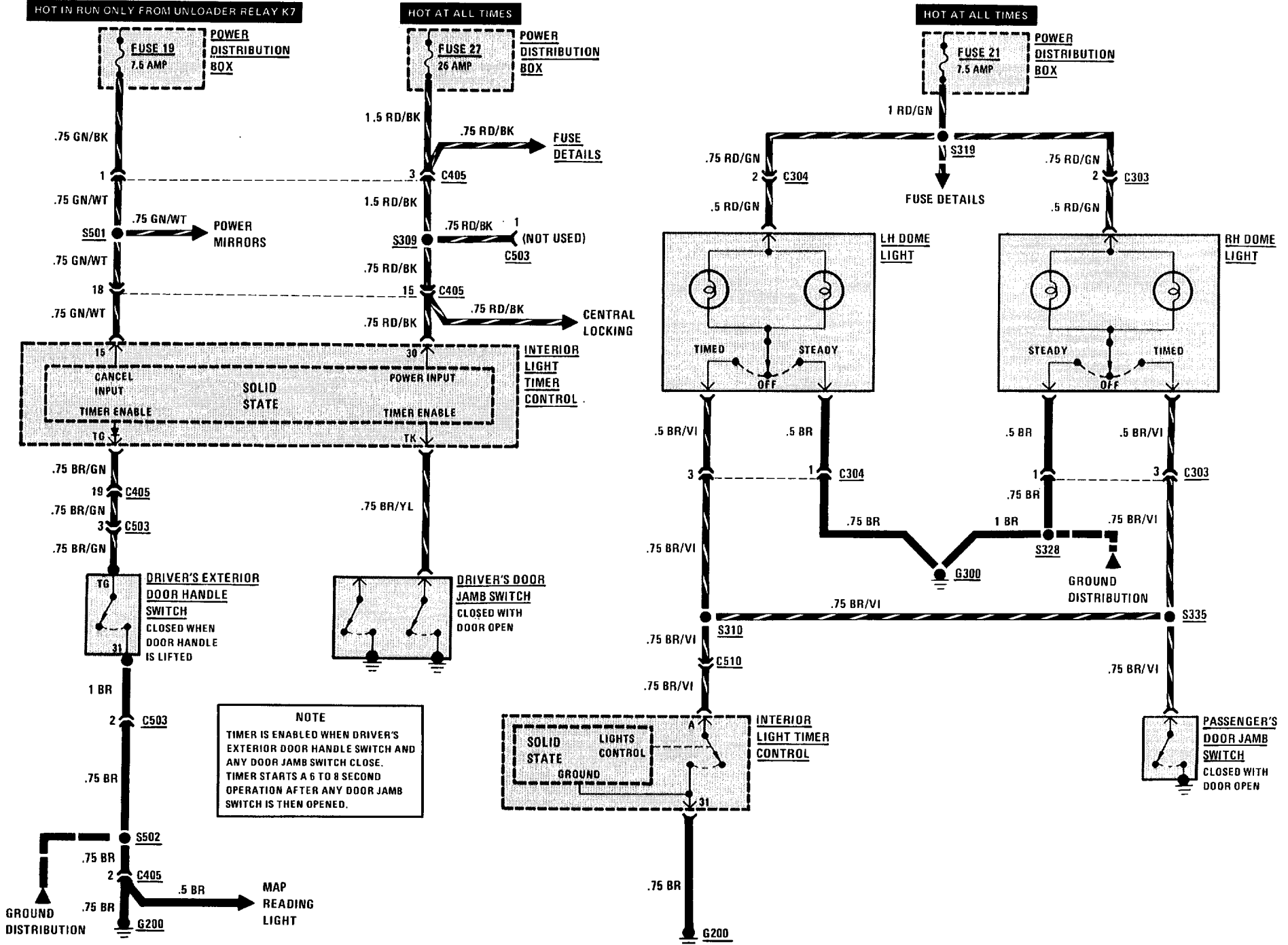

4 DOOR

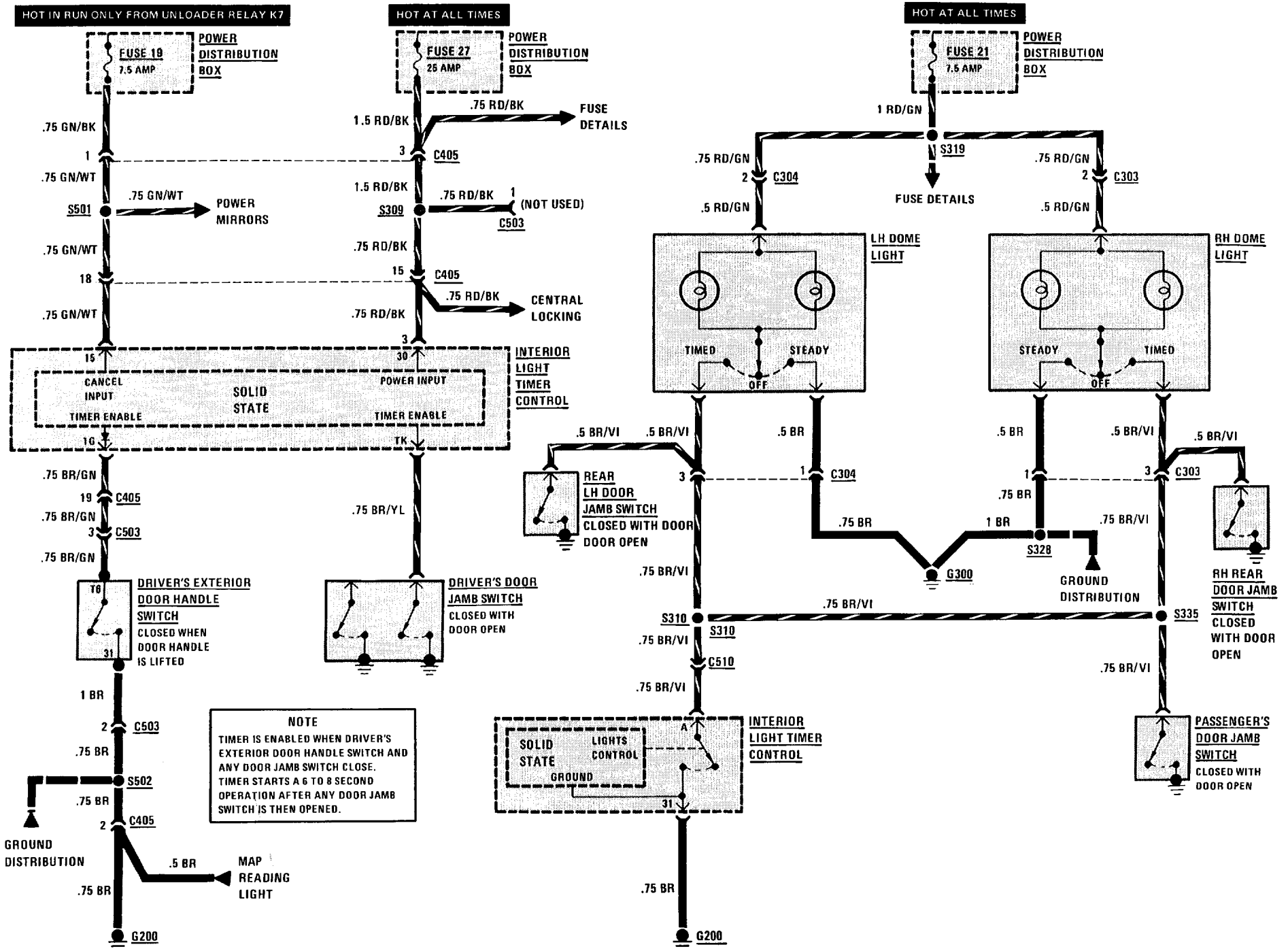

# 6411-0 A/C TEMPERATURE CONTROL

## HEATING AND AIR CONDITIONING (HOT WATER CONTROL)

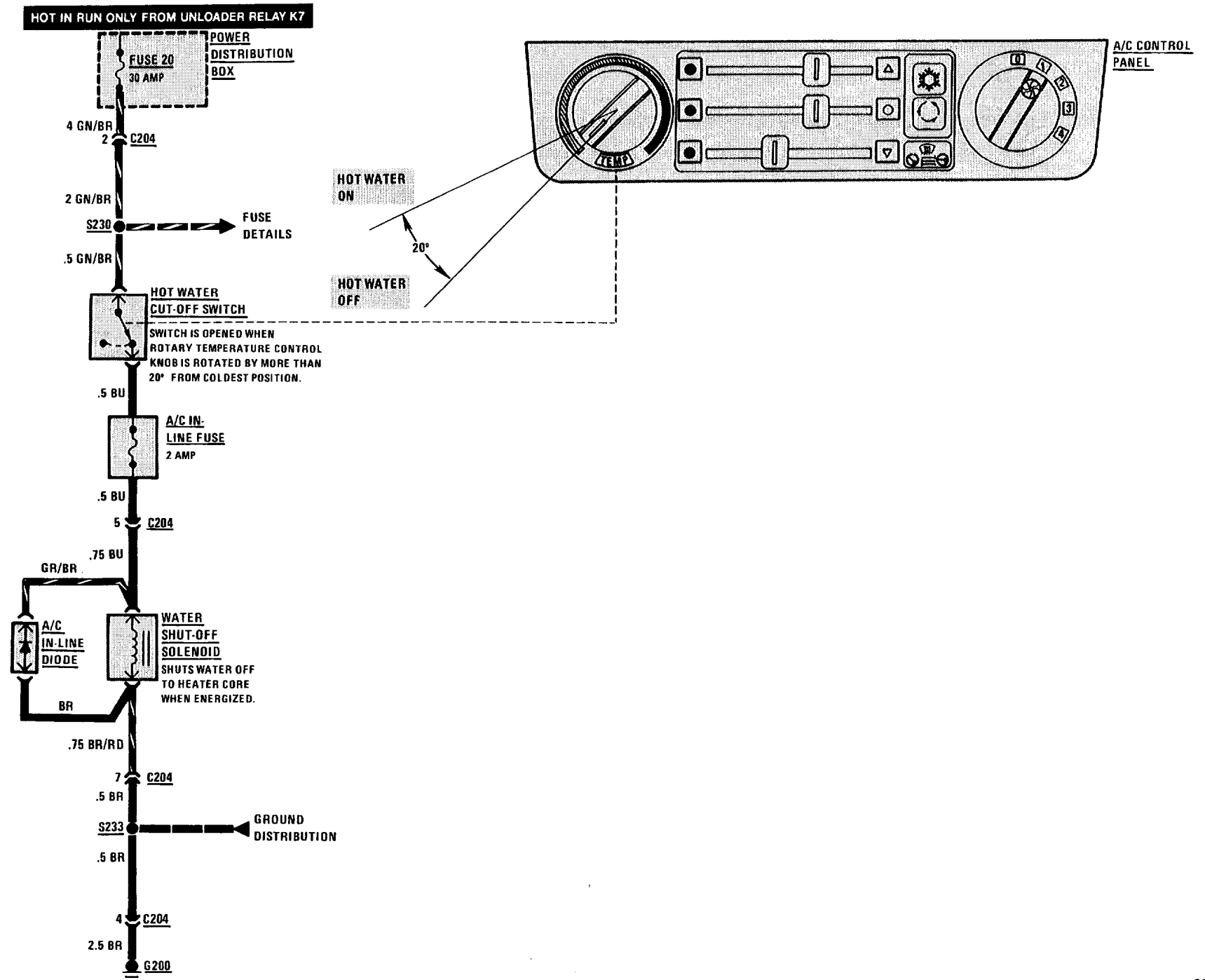

HEATING AND AIR CONDITIONING (BLOWER CONTROLS)

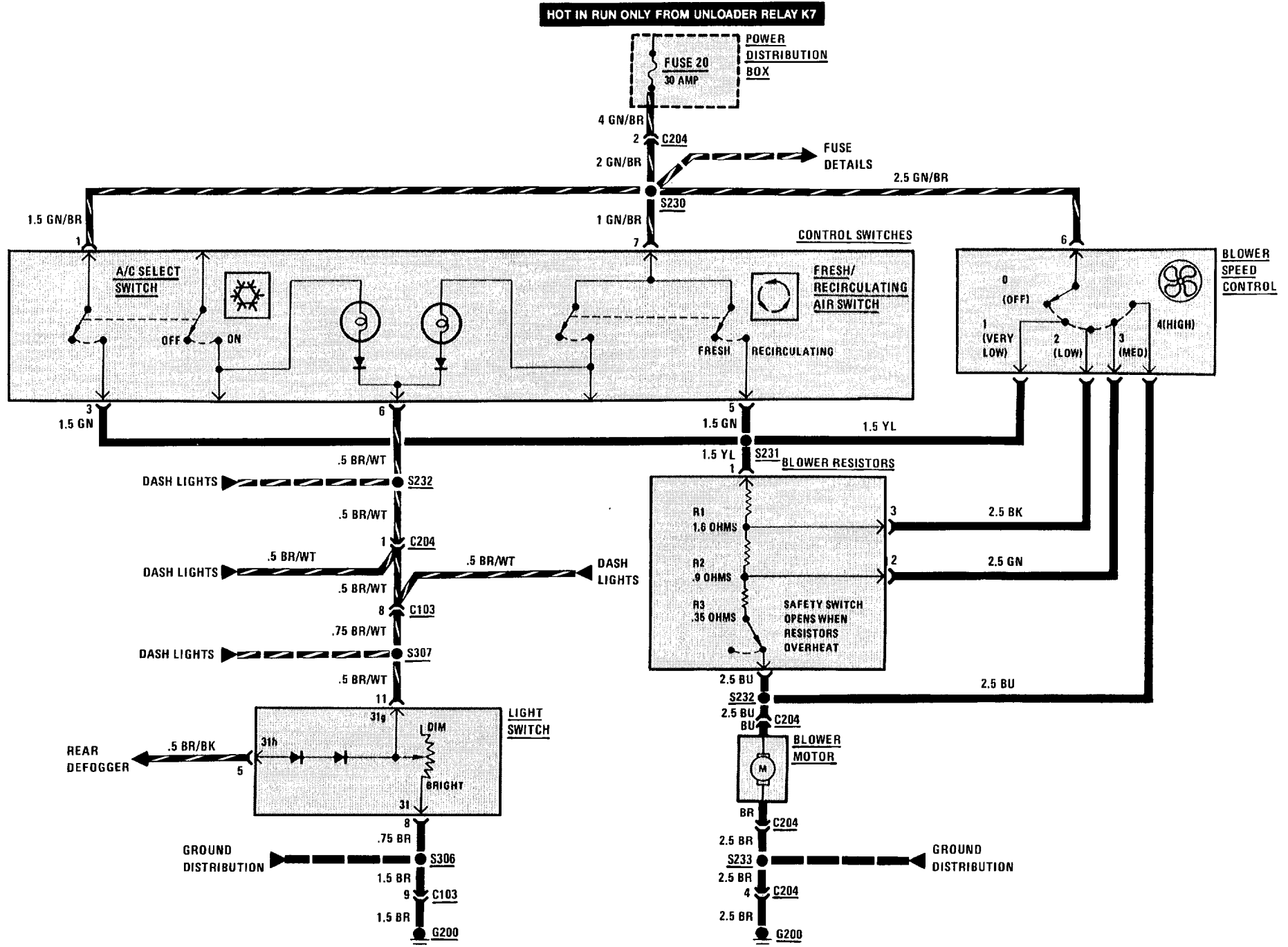

HEATING AND AIR CONDITIONING (FRESH/RECIRCULATING AIR CONTROLS)

HOT IN RUN ONLY FROM UNLOADER RELAY K7

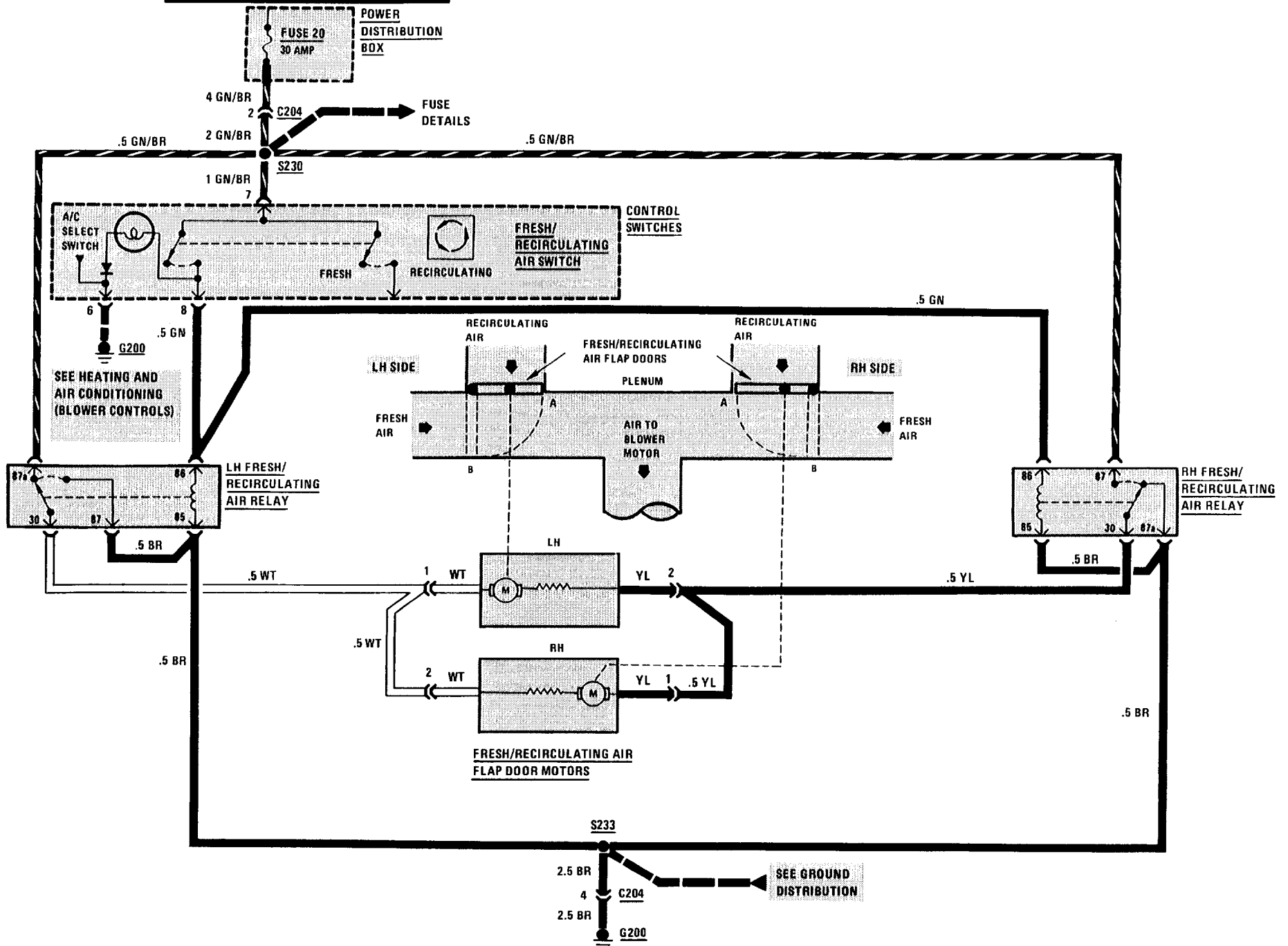

HEATING AND AIR CONDITIONING (COMPRESSOR CONTROLS)

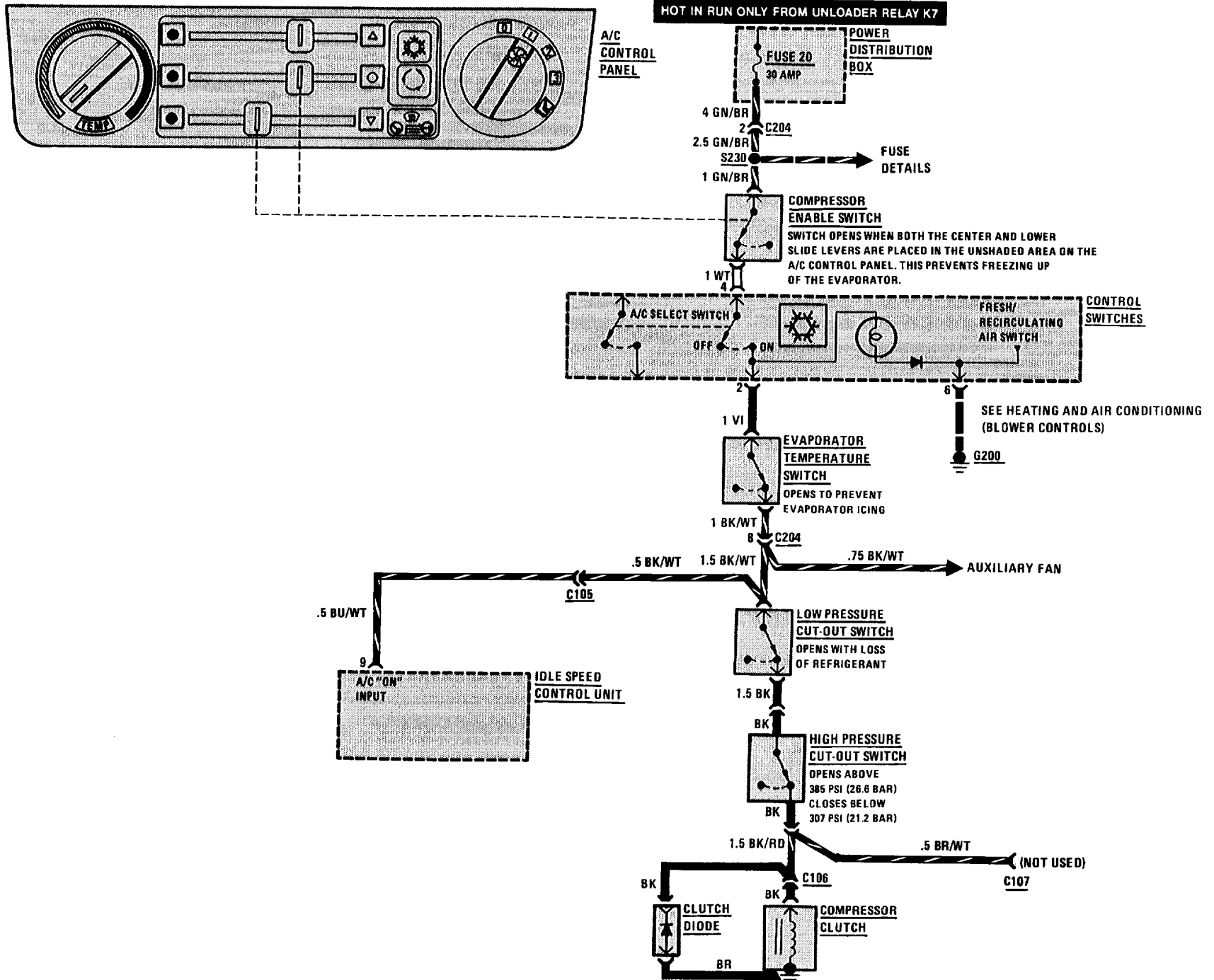

# 6454-0 AUXILIARY FAN

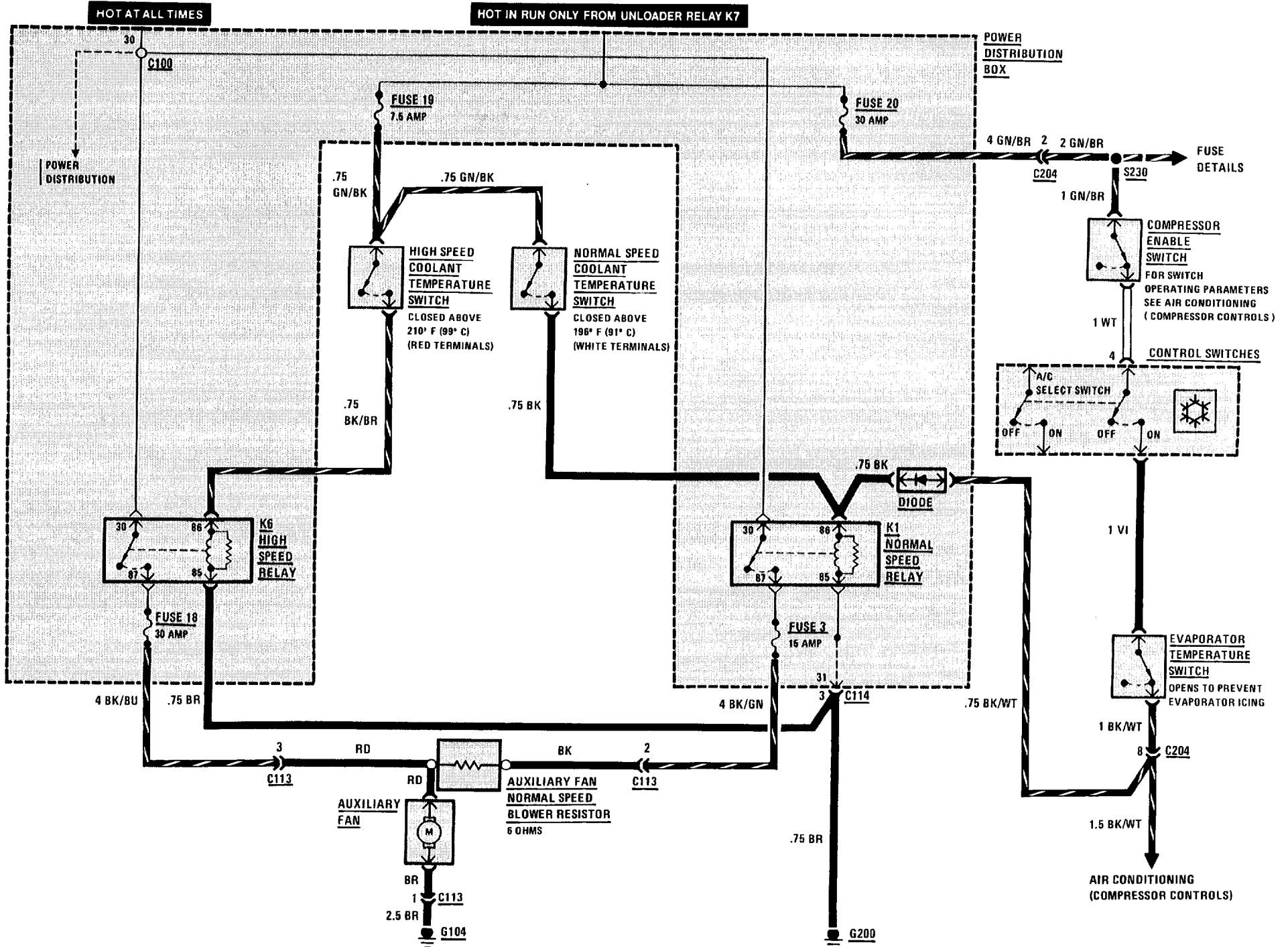



# 6500-0 RADIO/ANTENNA

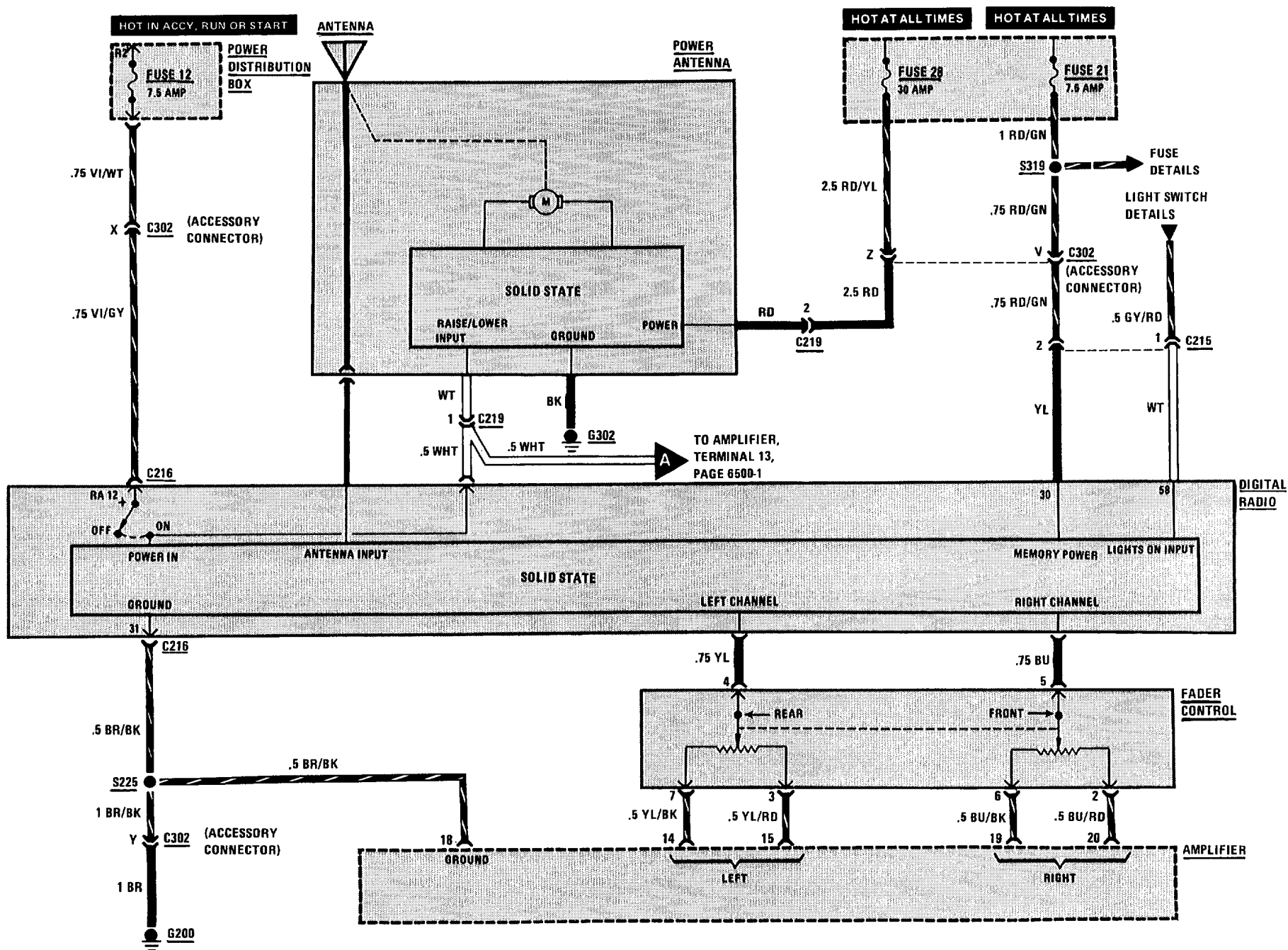

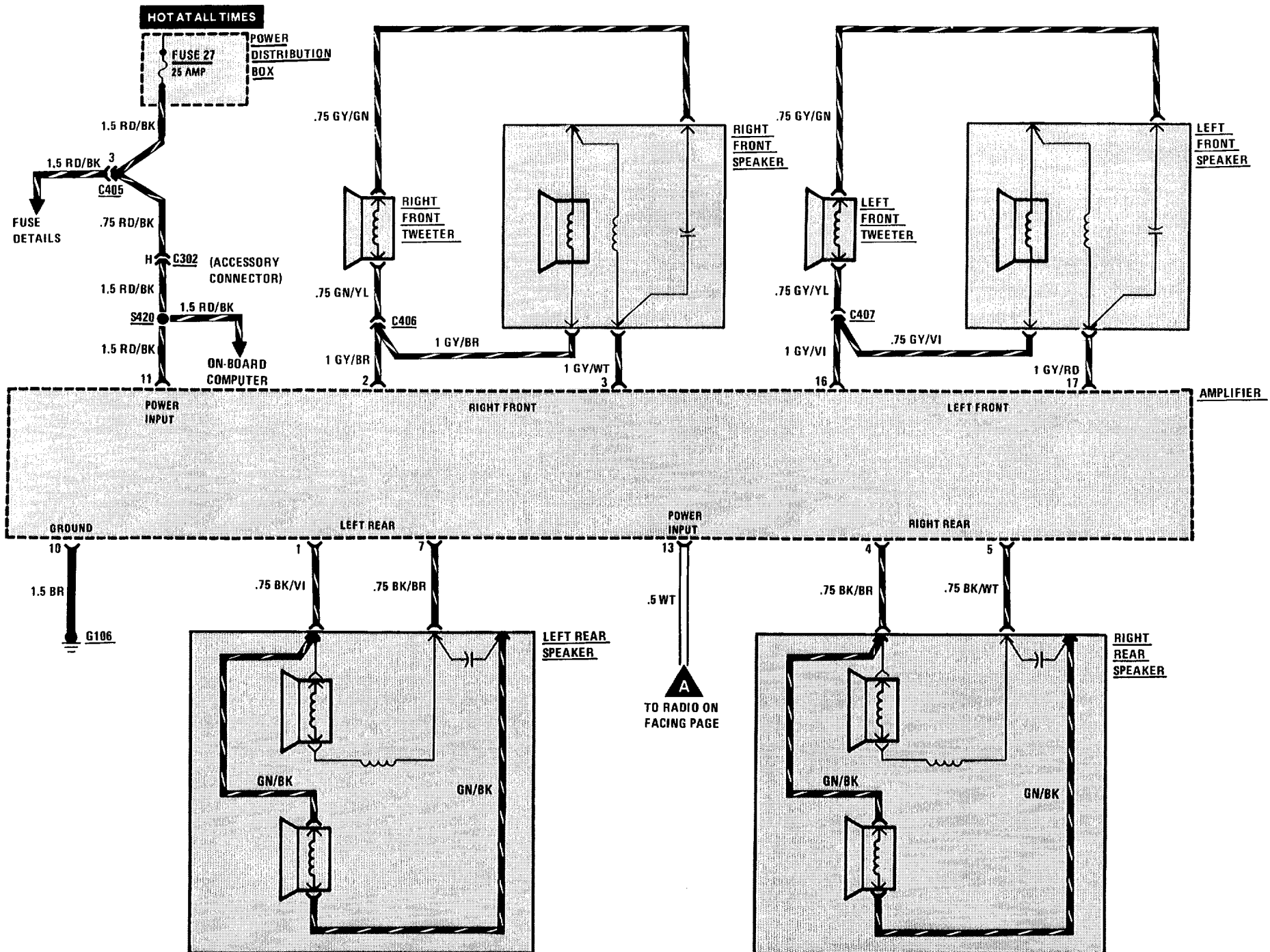



# 6581-0 ON-BOARD COMPUTER

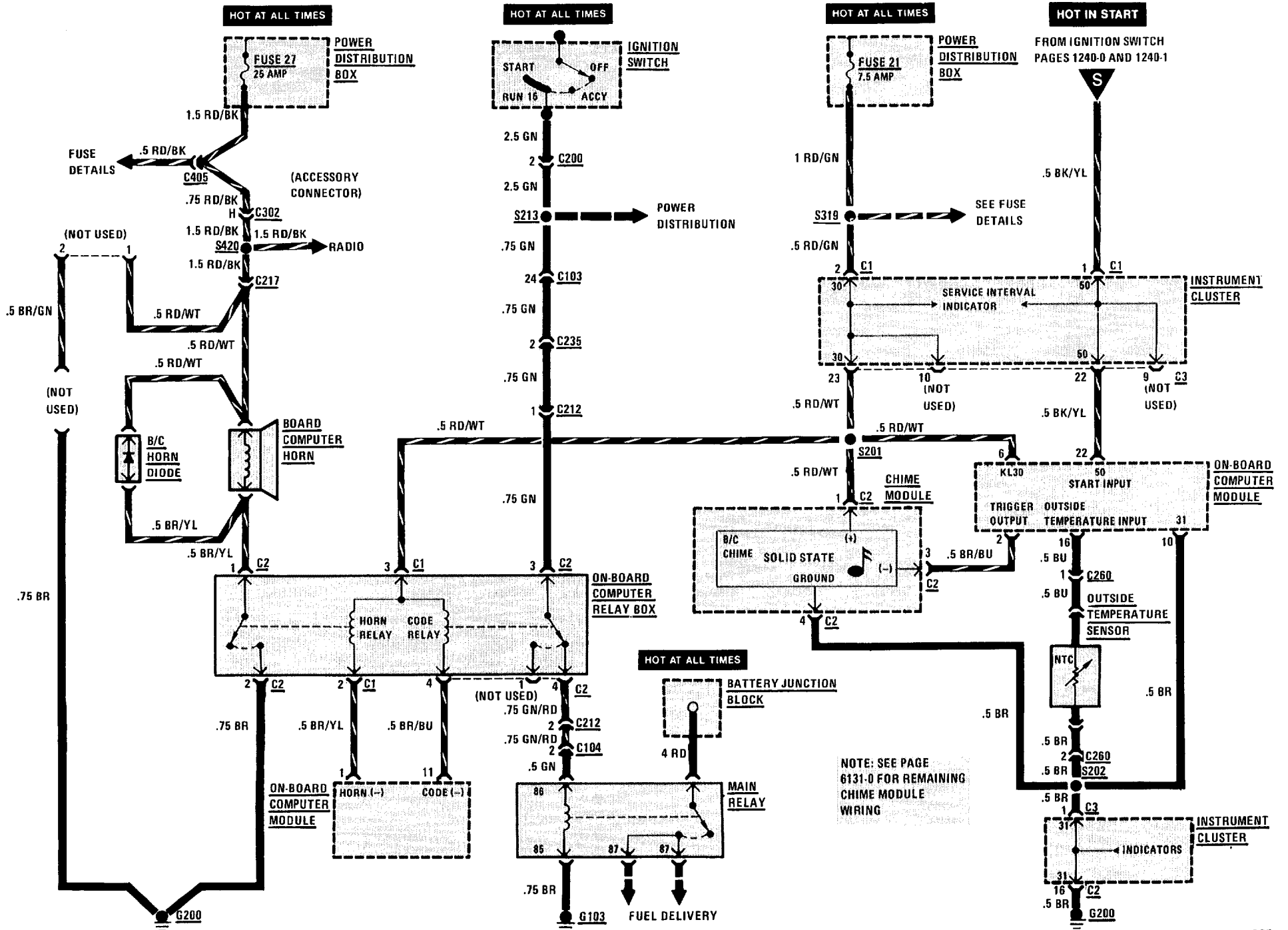

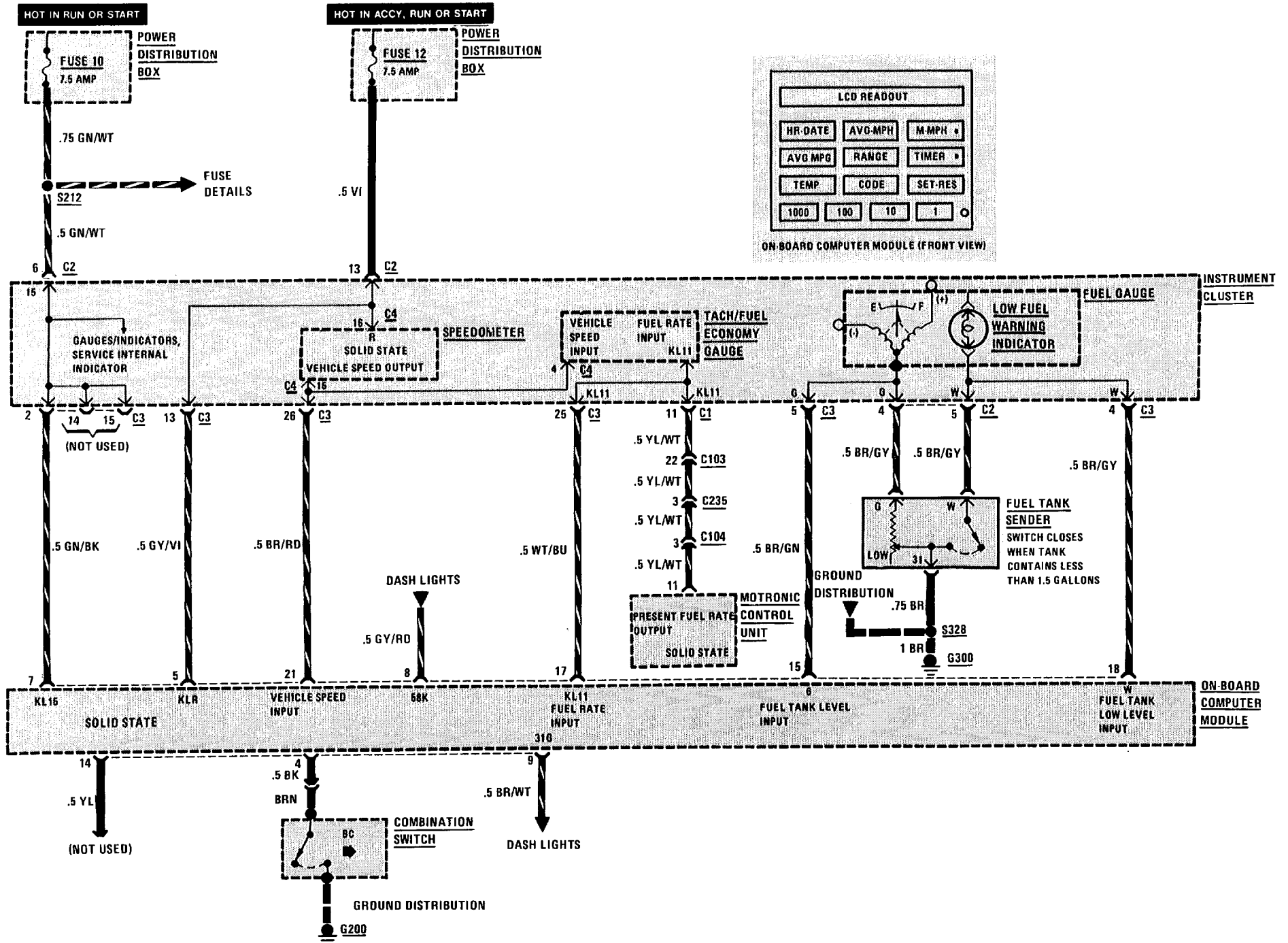

# 6581-2 MULTIFUNCTION CLOCK

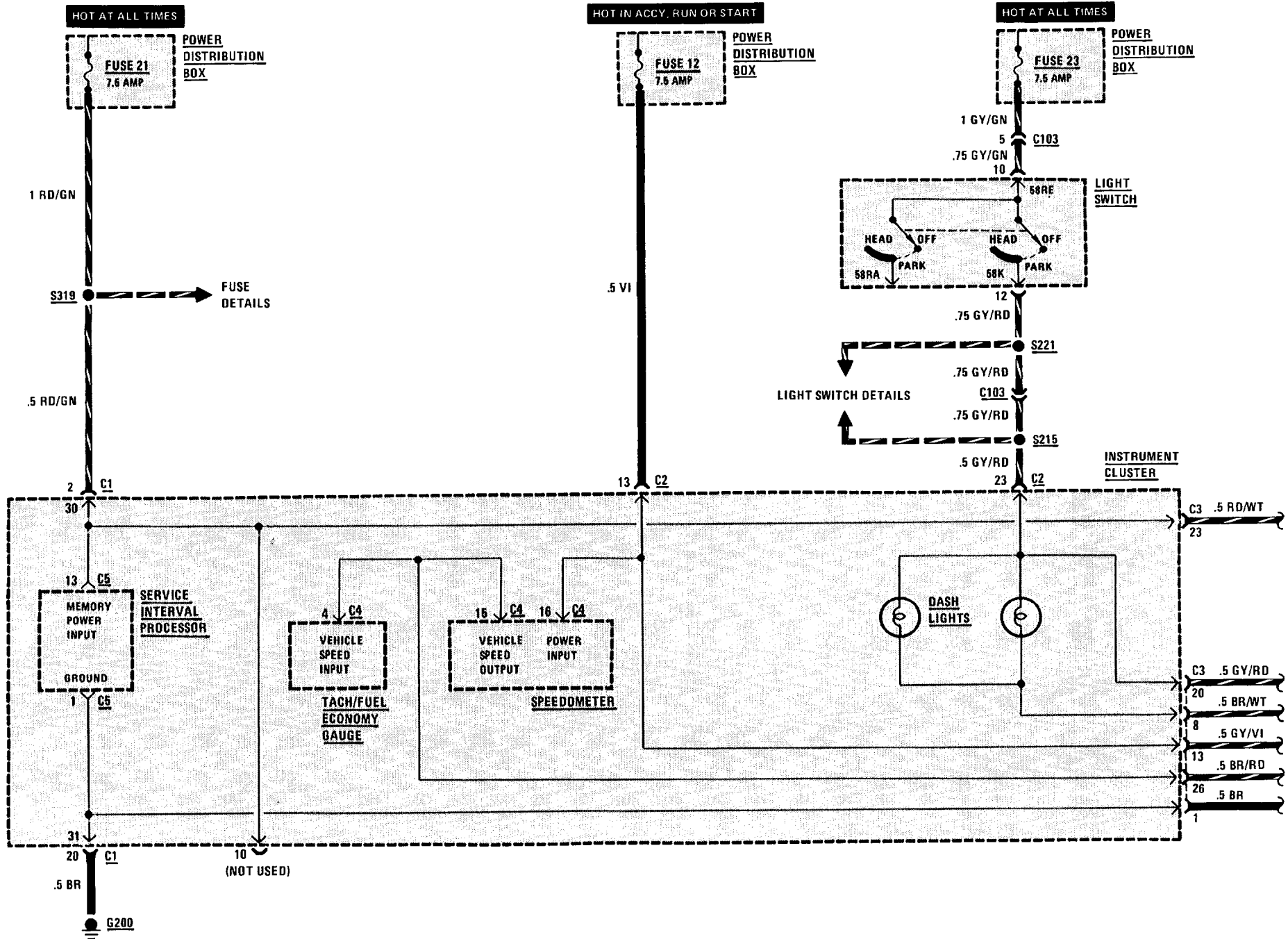

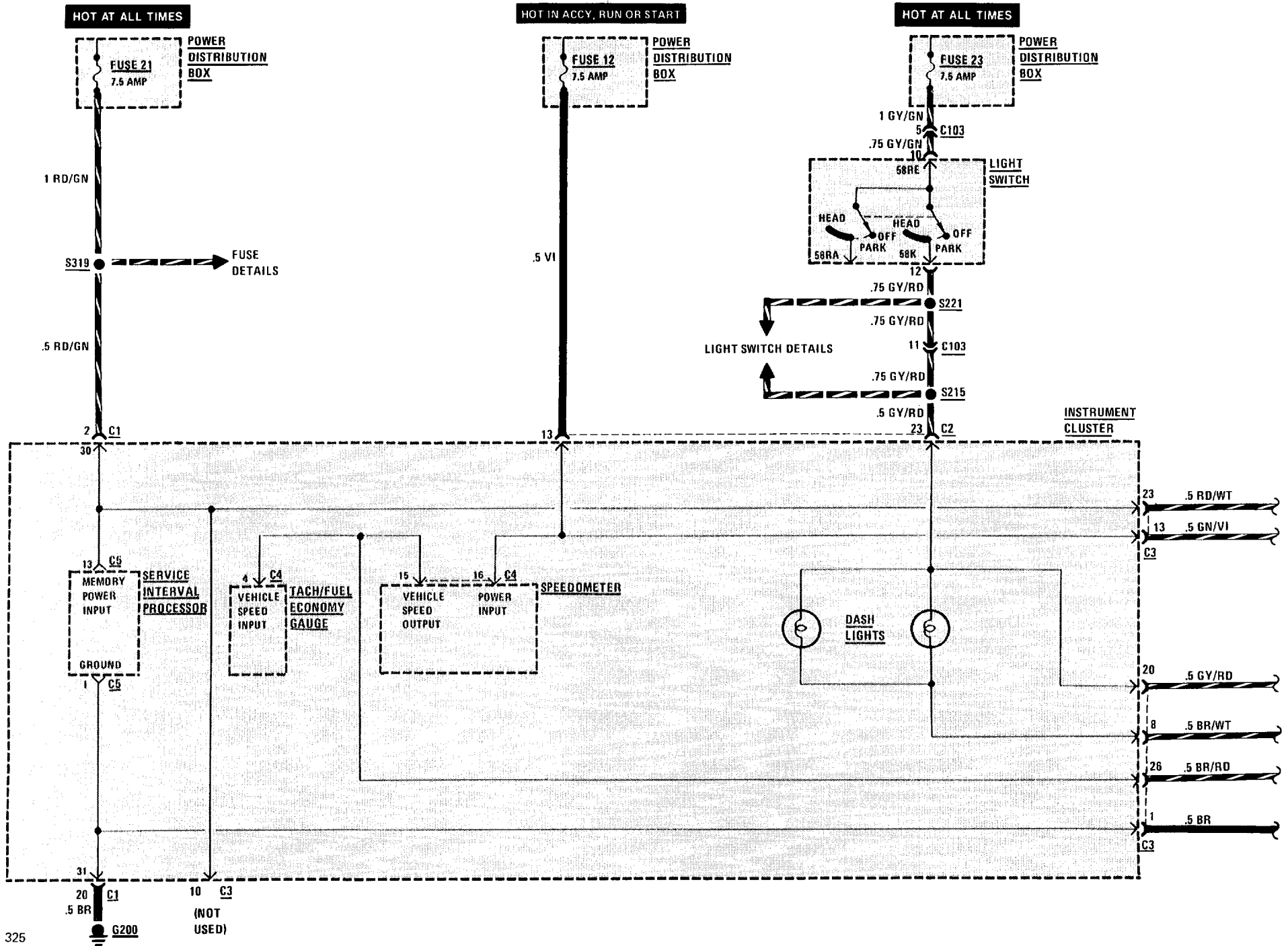

# 6581-4 MULTIFUNCTION CLOCK LATE PRODUCTION

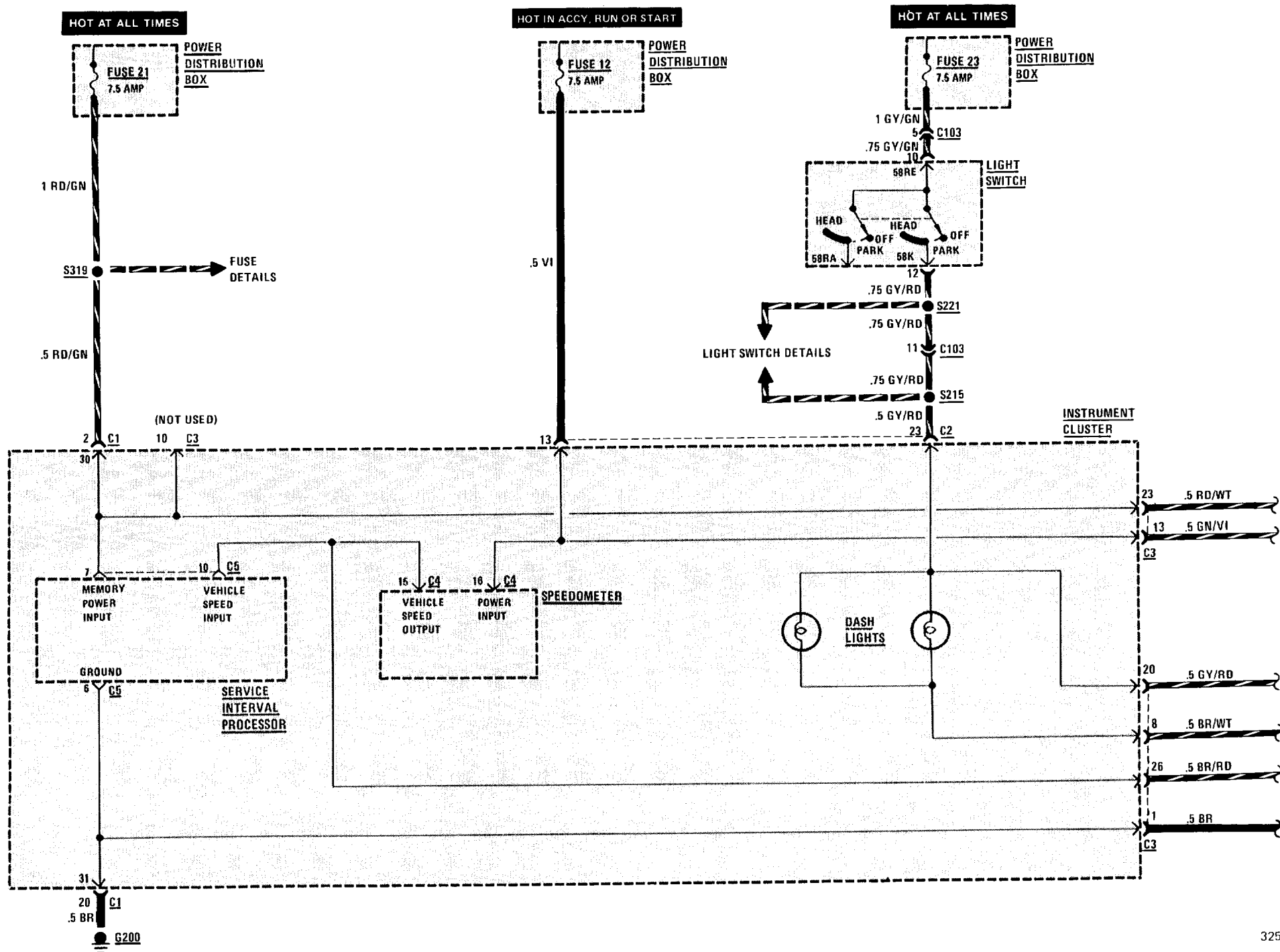



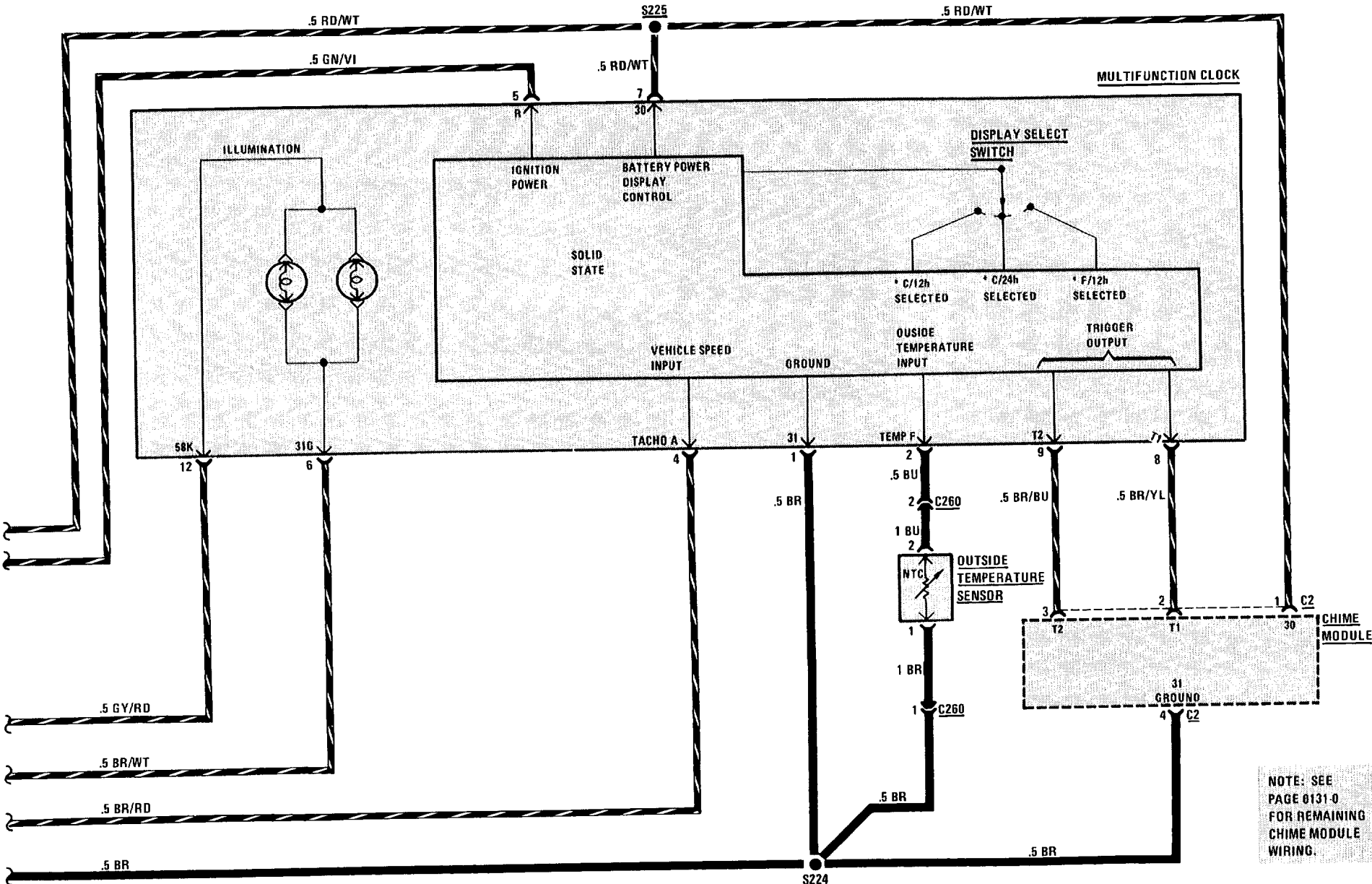

NOTE: SEE PAGE 0131-0 FOR REMAINING CHIME MODULE WIRING.

# 7000-0 COMPONENT LOCATION VIEWS



Figure 1 - LH Rear of Engine Compartment

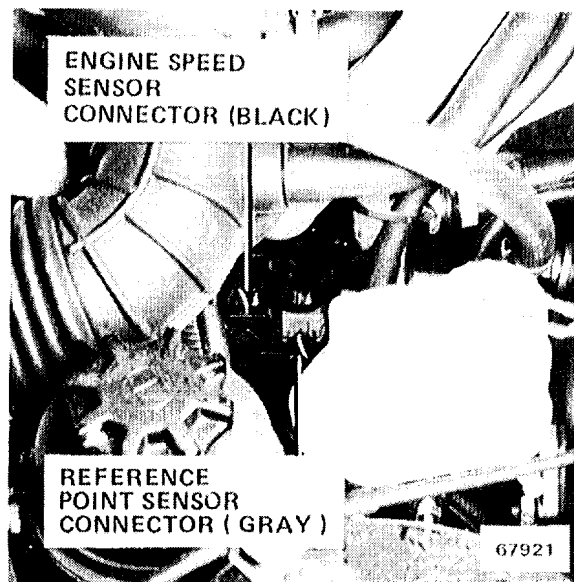

Figure 3 - Lower LH Rear of Engine

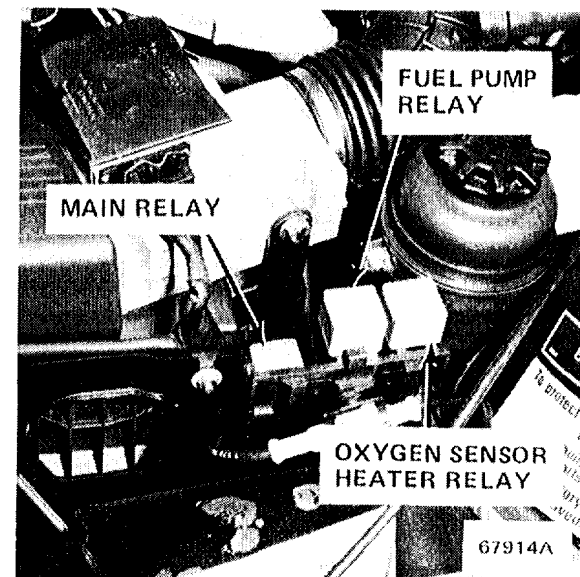

Figure 5 - Forward of LH Front Shock Tower (Relay Cover Removed)

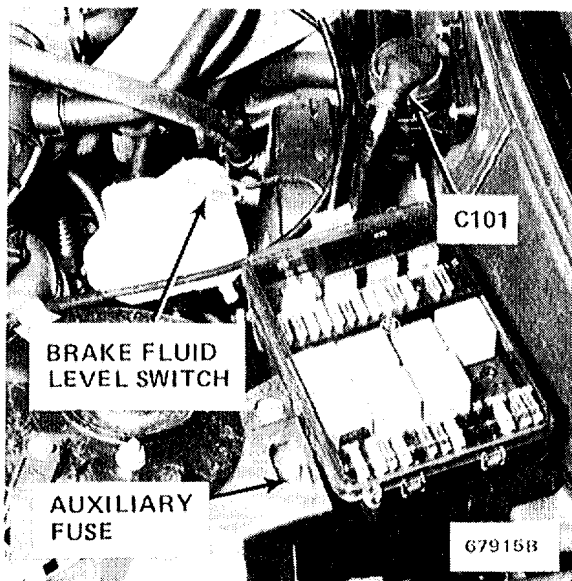

Figure 2 - LH Rear of Engine Compartment



Figure 4 - Top LH Side of Engine

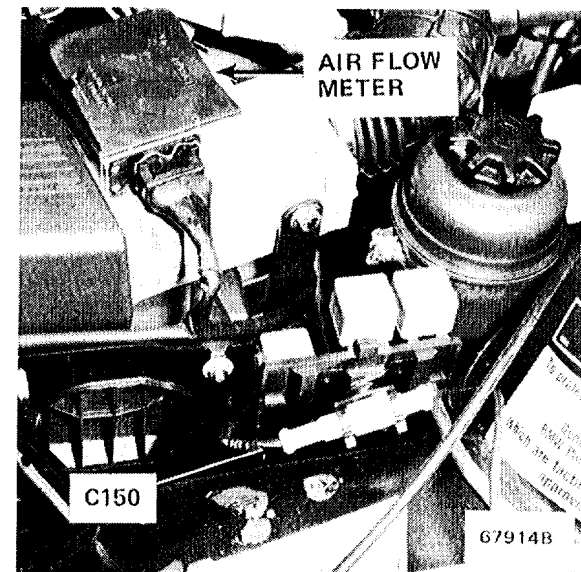

Figure 6 - Forward of LH Front Shock Tower

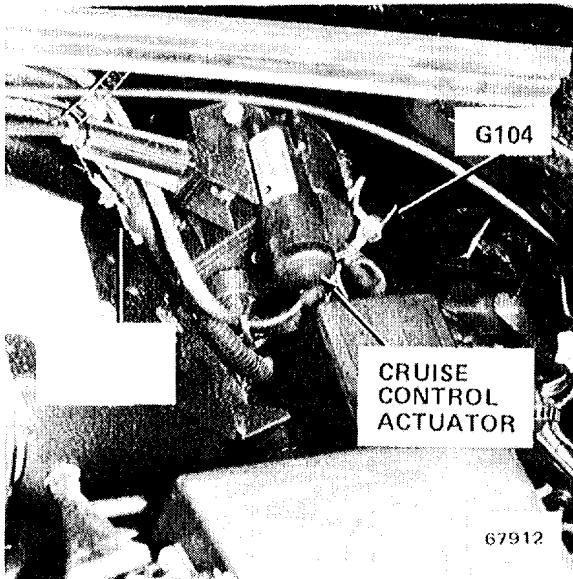

Figure 1 - Forward of LH Front Wheel Well

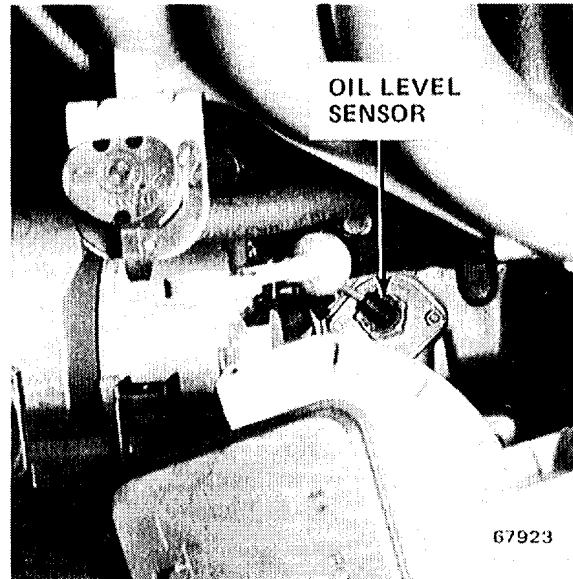

Figure 3 - Lower LH Side of Engine

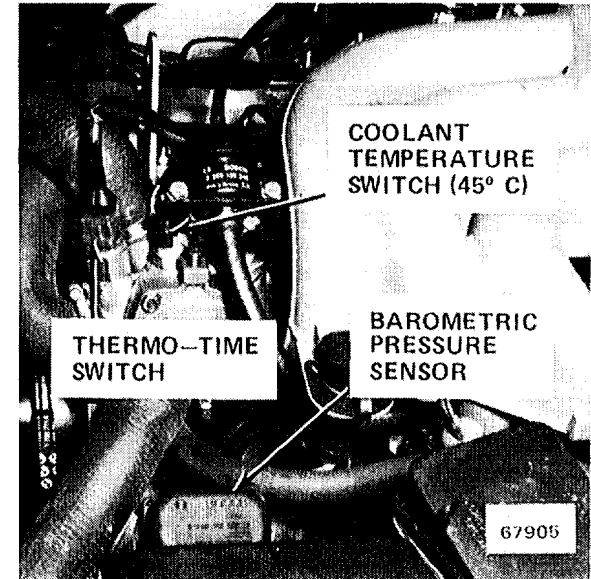

Figure 5 - Top Front of Engine

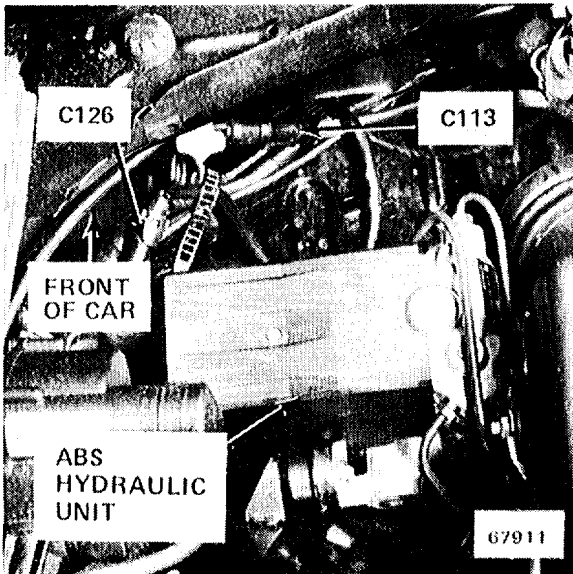

Figure 2 - LH Front of Engine Compartment (Cover Removed)

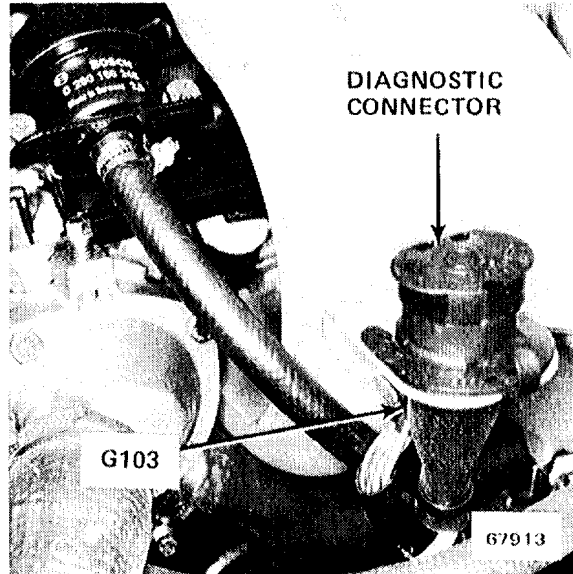

Figure 4 - Top LH Front of Engine

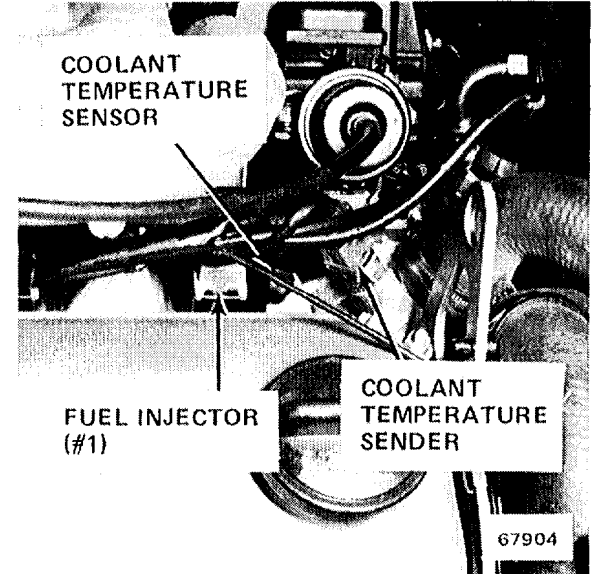

Figure 6 - Top Front of Engine

## 7000-2 COMPONENT LOCATION VIEWS

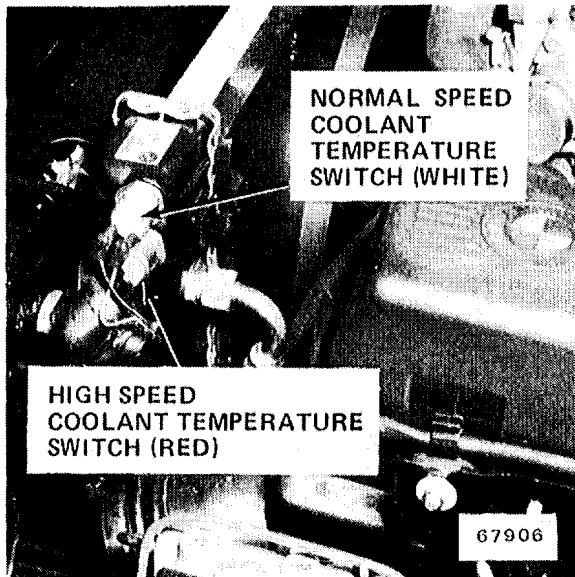

Figure 1 - Top LH Side of Radiator

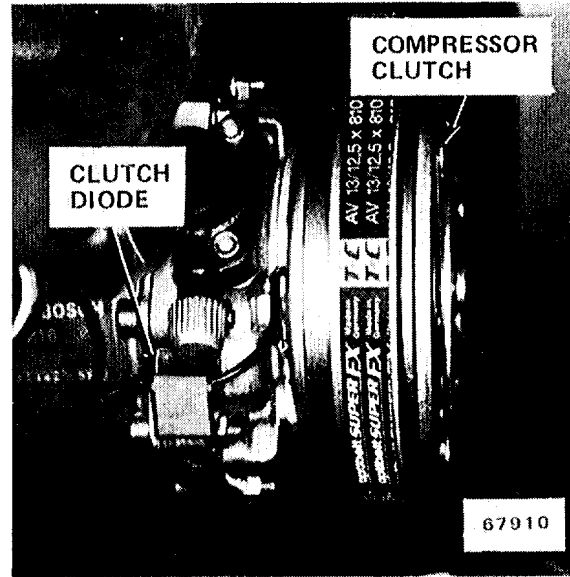

Figure 3 - Lower RH Front of Engine

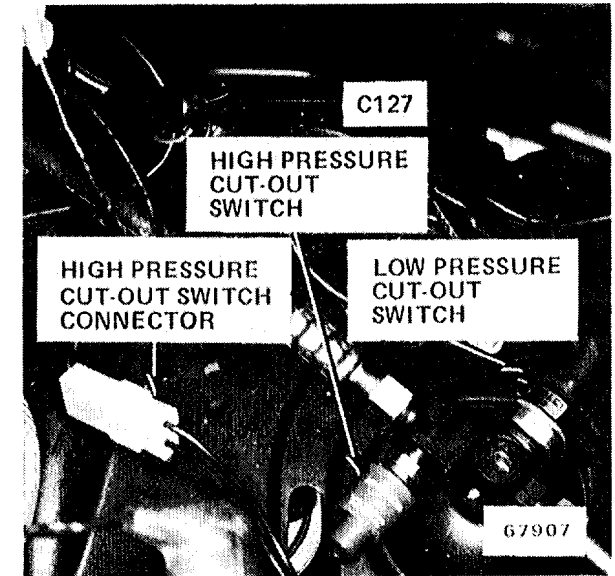

Figure 5 - Behind RH Headlights  
(Cover Removed)

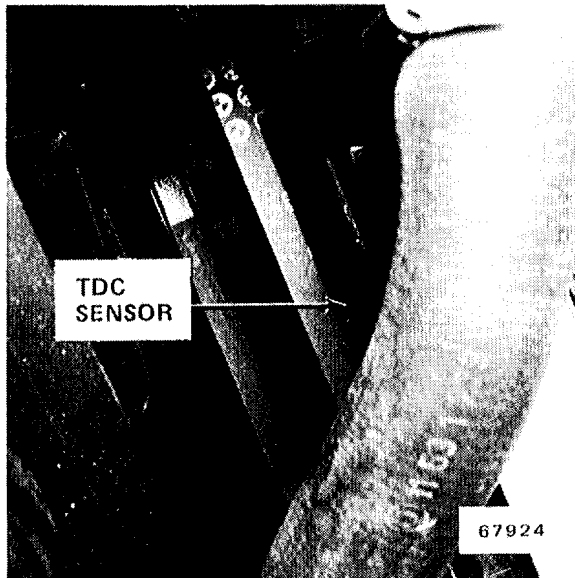

Figure 2 - Lower Front of Engine



Figure 4 - Lower RH Front of Engine

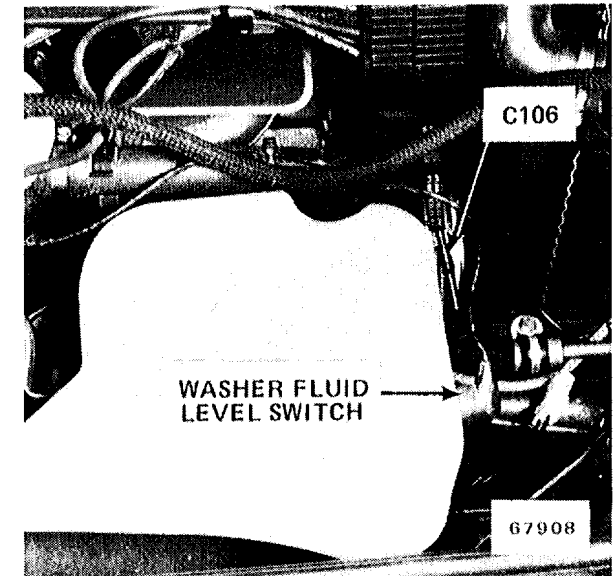

Figure 6 - RH Side of Engine Compartment

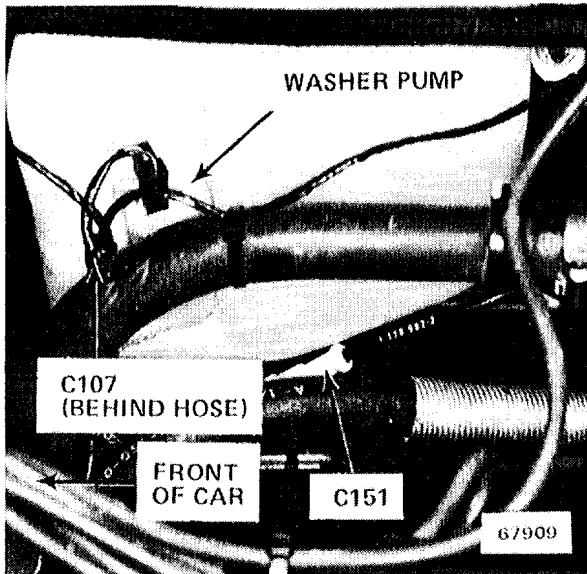

Figure 1 - RH Side of Engine Compartment

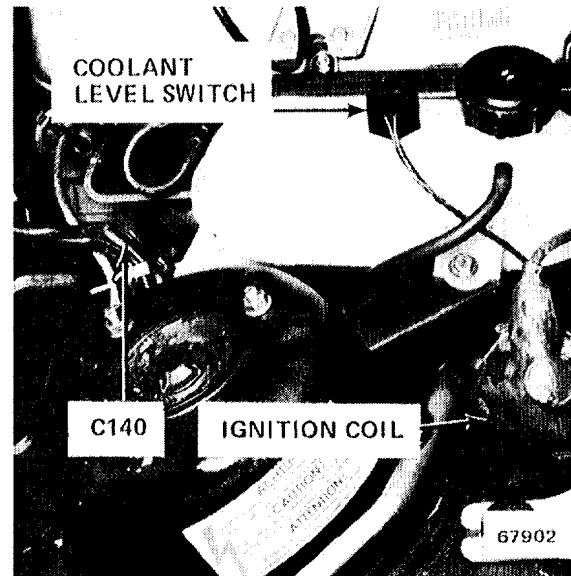

Figure 3 - RH Rear of Engine Compartment

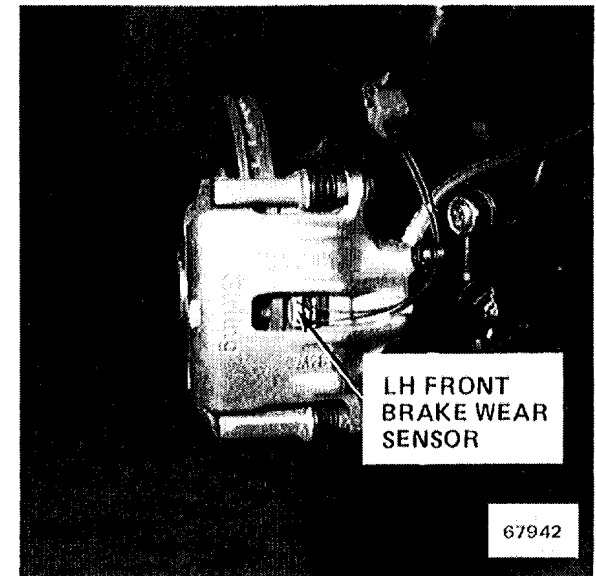

Figure 5 - LH Front Brake Assembly (Wheel Removed)

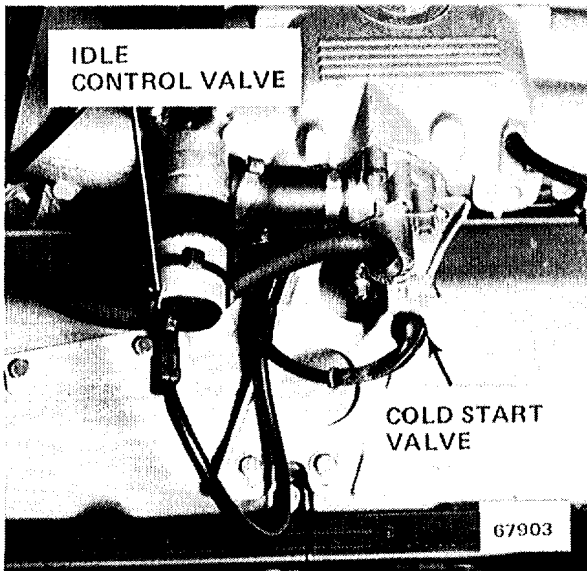

Figure 2 - RH Rear Side of Engine

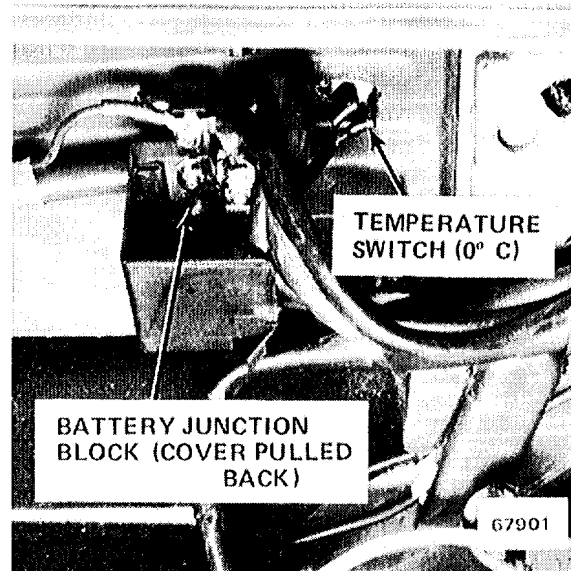

Figure 4 - RH Side of Engine Bulkhead



Figure 6 - LH Front Spindle Assembly

# 7000-4 COMPONENT LOCATION VIEWS

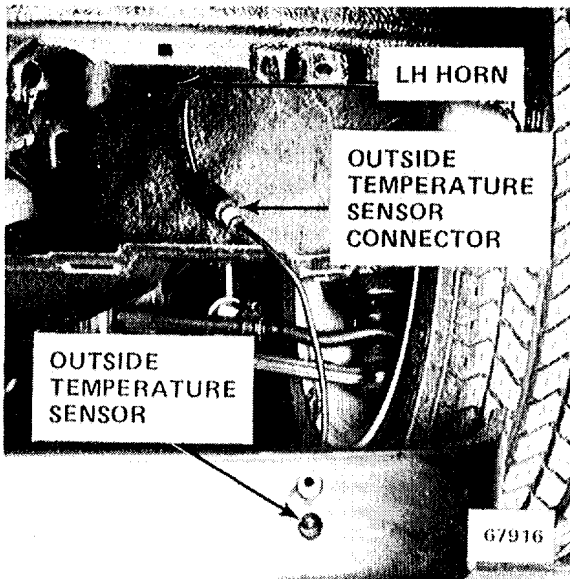

Figure 1 - Under LH Side of Front Bumper (Splash Guard Pulled Down)

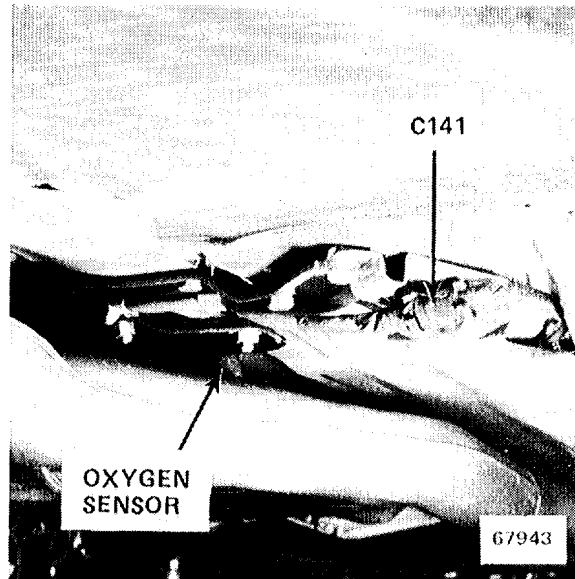

Figure 3 - Under RH Side of Car

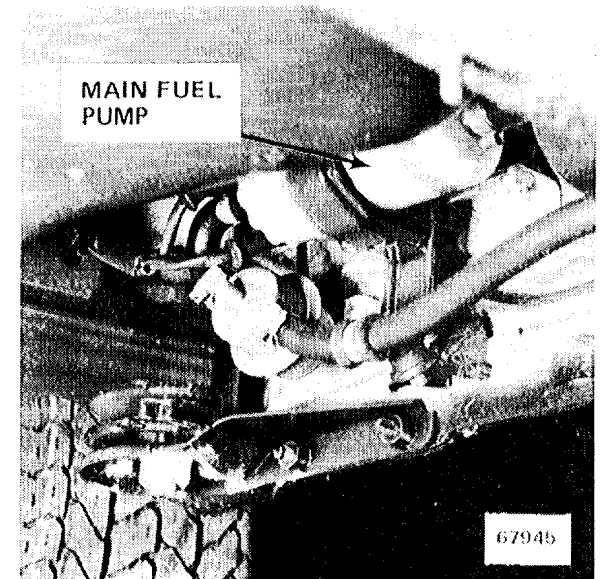

Figure 5 - Ahead of LH Rear Wheel

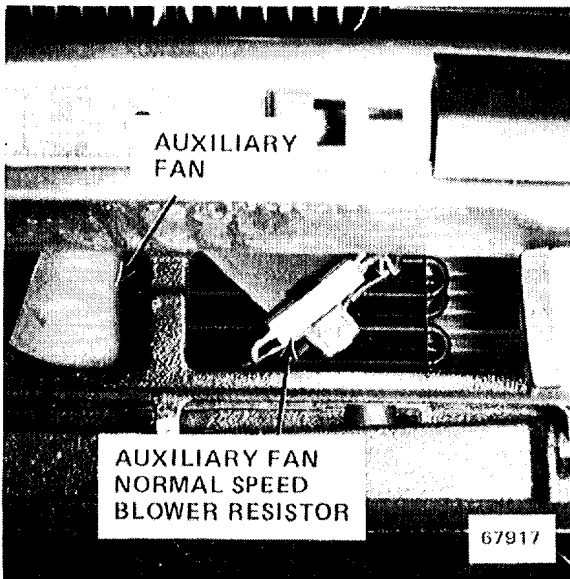

Figure 2 - Under Middle of Front Bumper

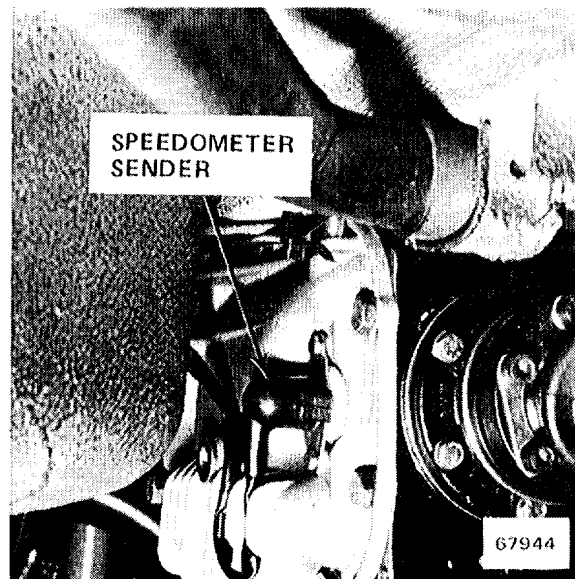

Figure 4 - RH Rear of Differential



Figure 6 - Inside LH Front Door (Panel Removed)

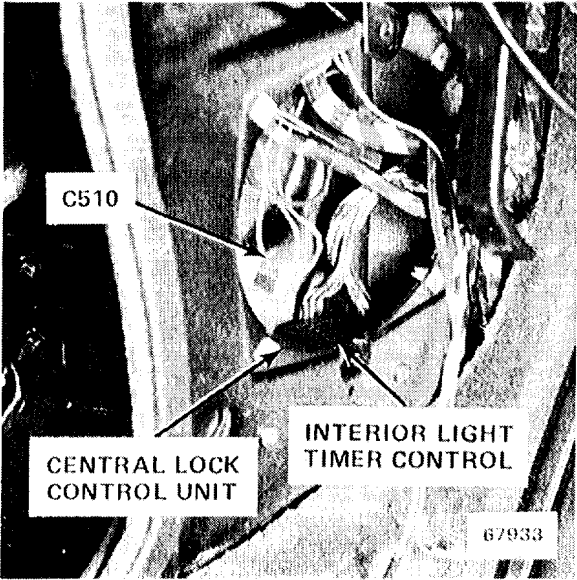

Figure 1 - Behind Left Front Speaker

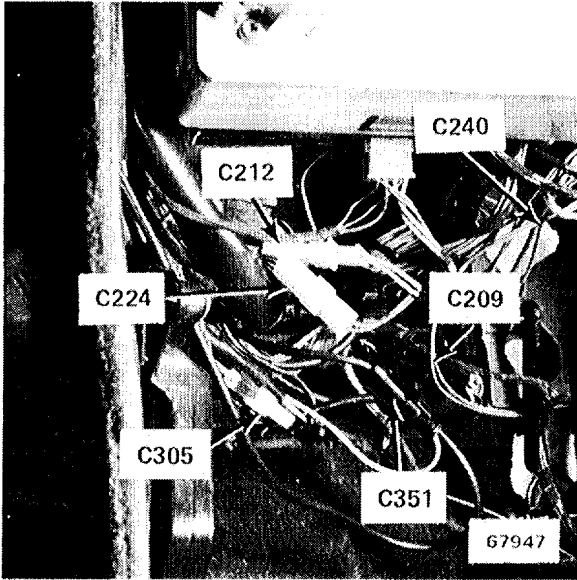

Figure 3 - Under LH Side of Dash

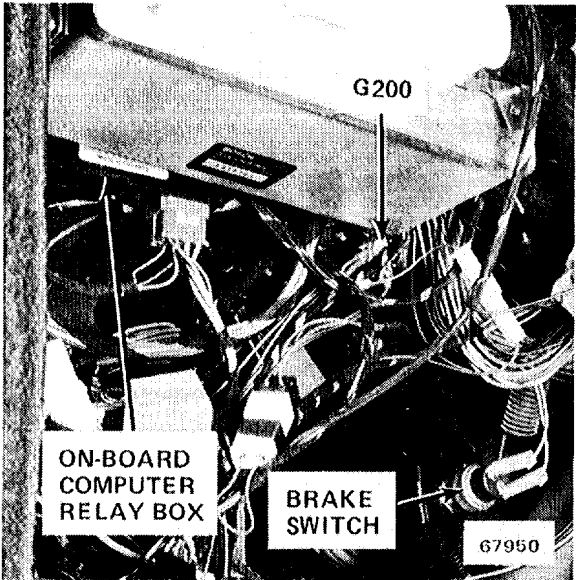

Figure 5 - Under LH Side of Dash

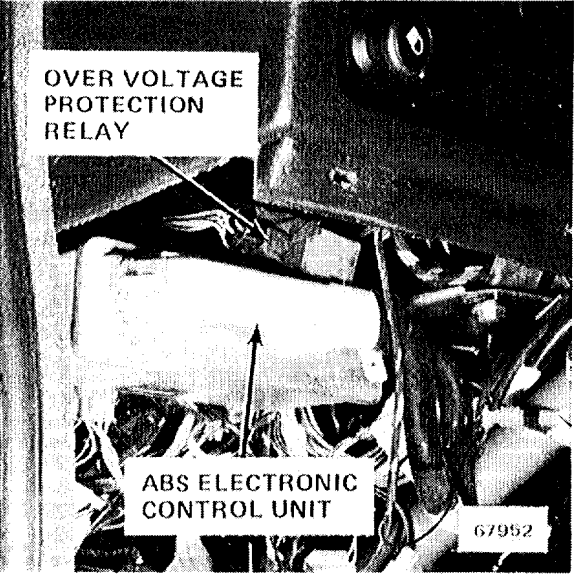

Figure 2 - Under LH Side of Dash

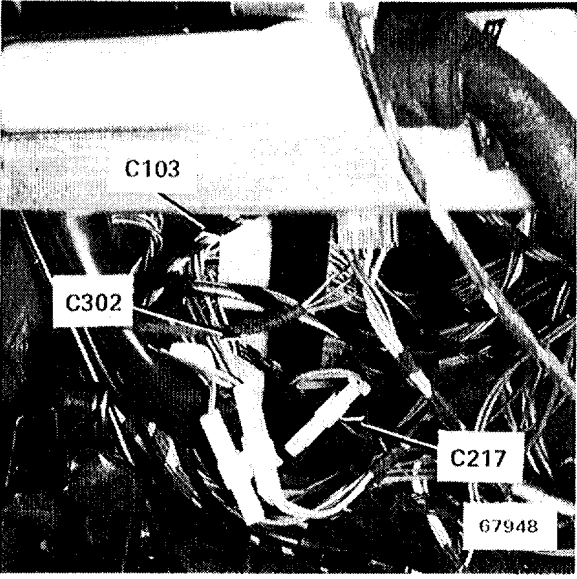

Figure 4 - Under LH Side of Dash

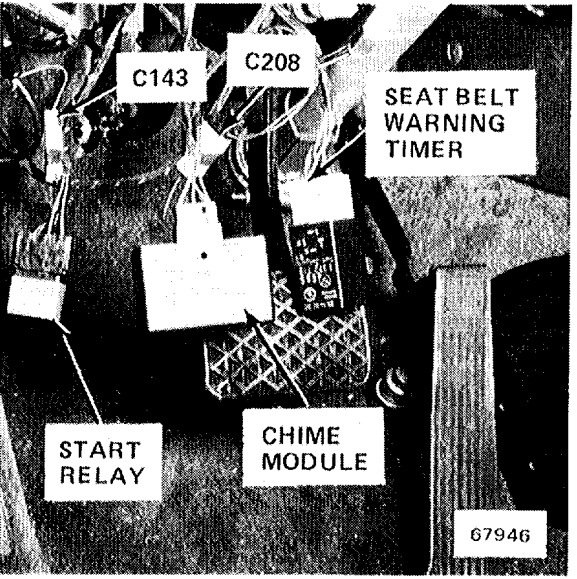

Figure 6 - Under LH Side of Dash

# 7000-6 COMPONENT LOCATION VIEWS

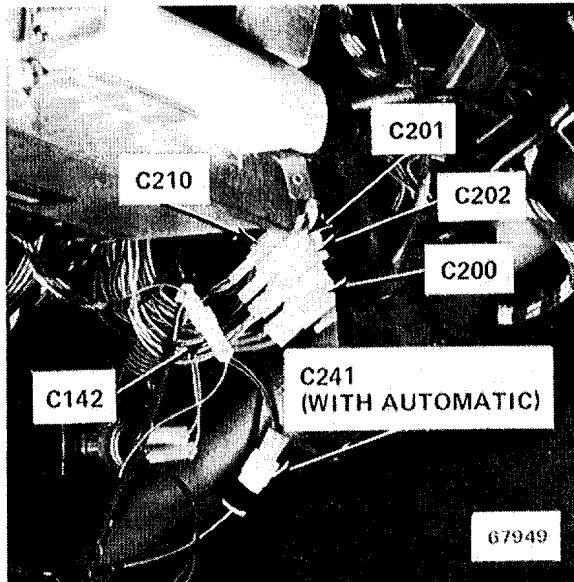

Figure 1 - Under LH Side of Dash

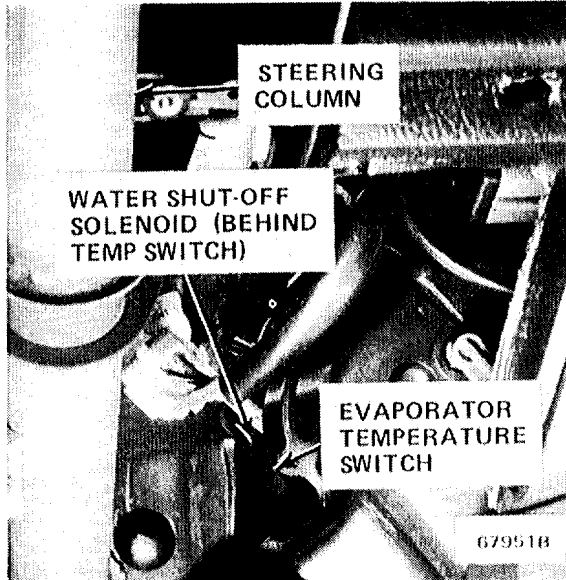

Figure 3 - Under LH Side of Dash

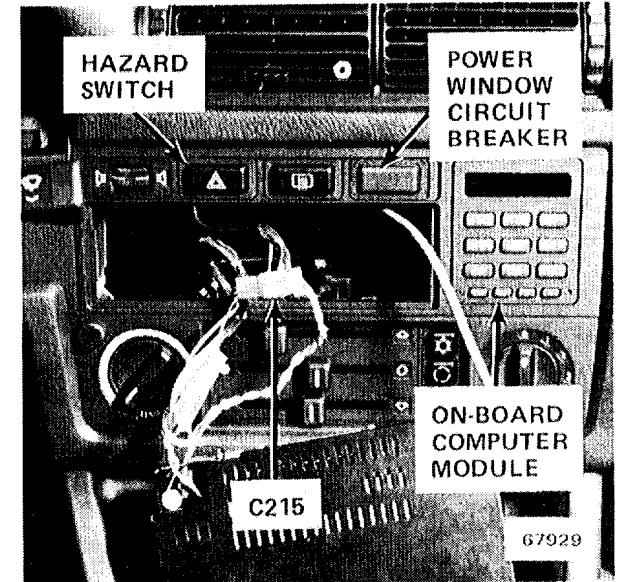

Figure 5 - Center of Dash

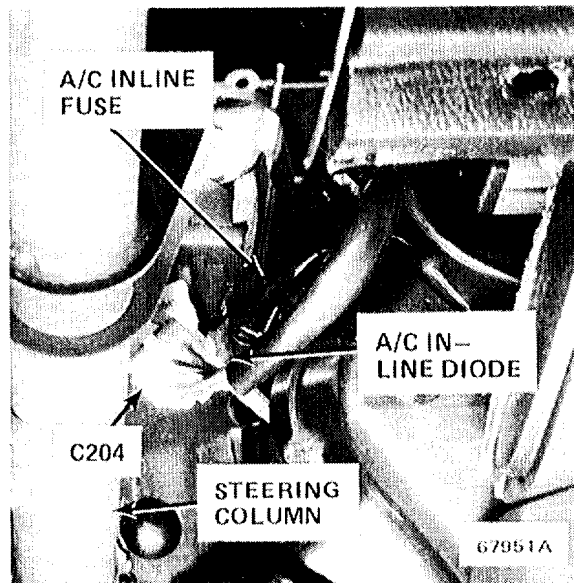

Figure 2 - Under LH Side of Dash

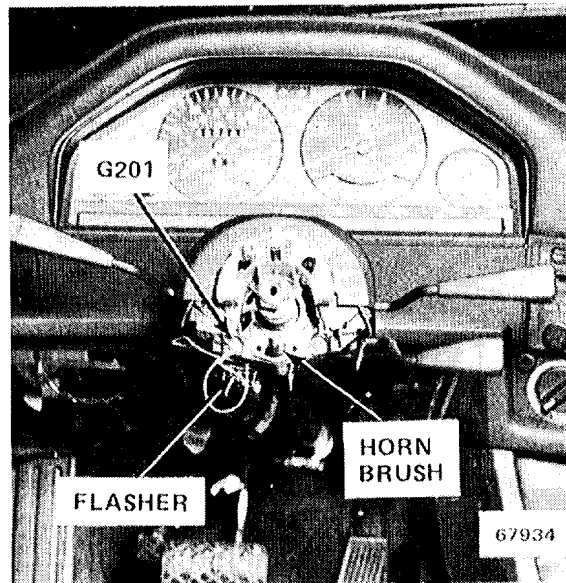

Figure 4 - Top of Steering Column

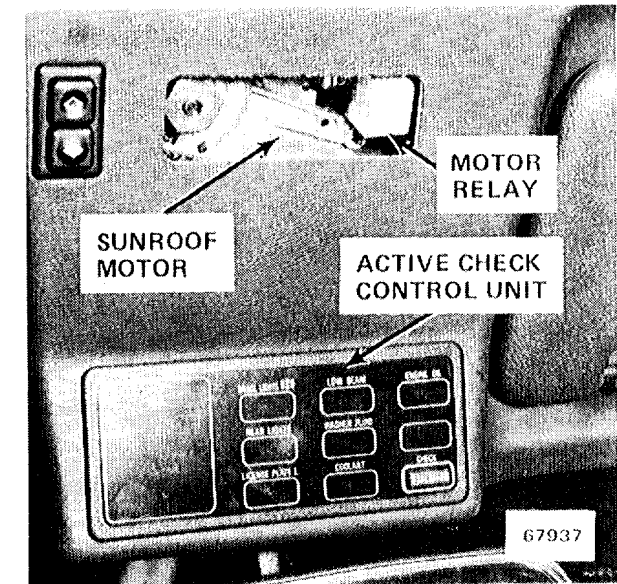

Figure 6 - Center of Windshield Header



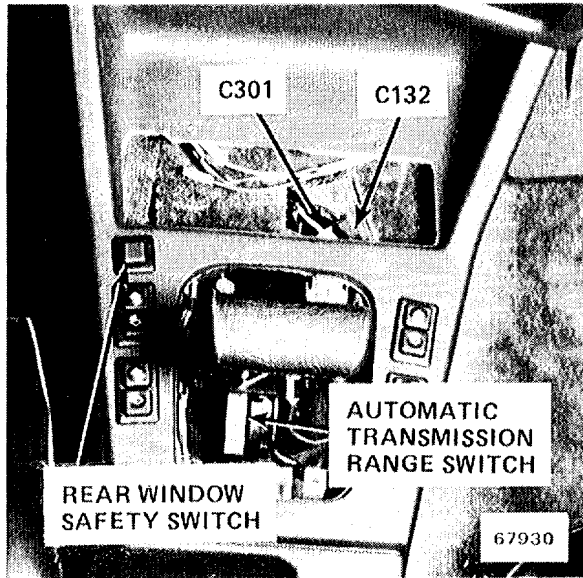

Figure 1 - Center Console

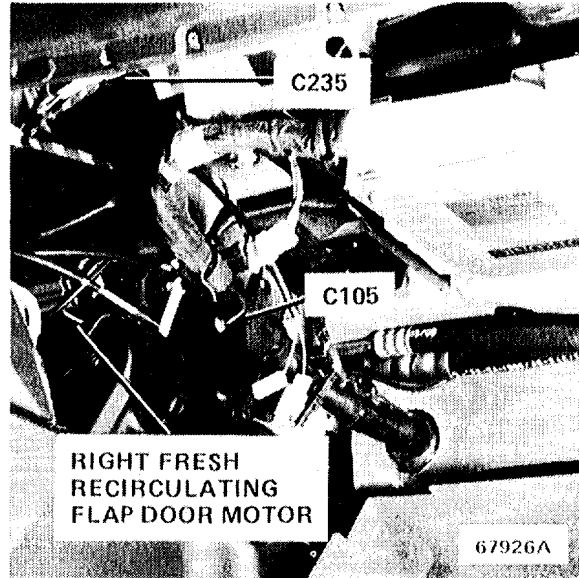

Figure 3 - Behind Right Side of Center Console

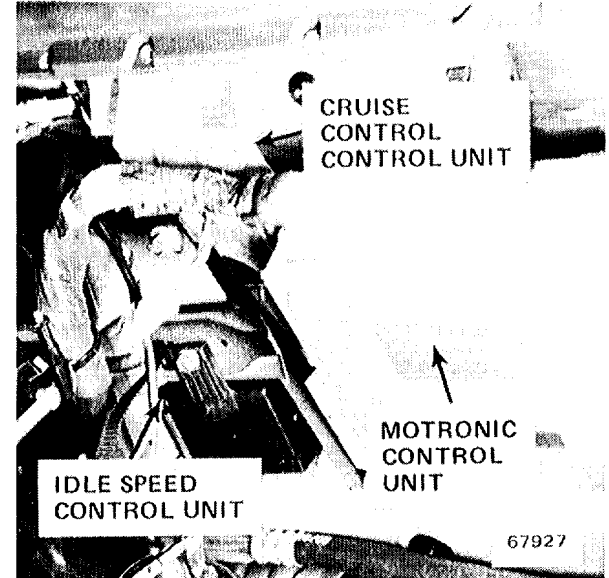

Figure 5 - Under RH Side of Dash

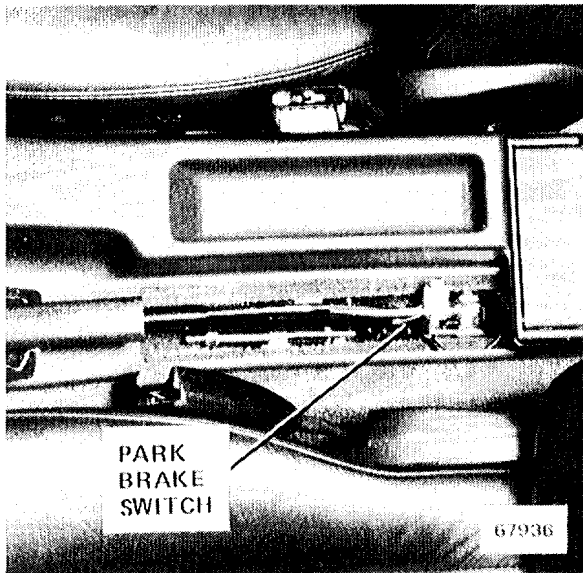

Figure 2 - Rear of Center Console

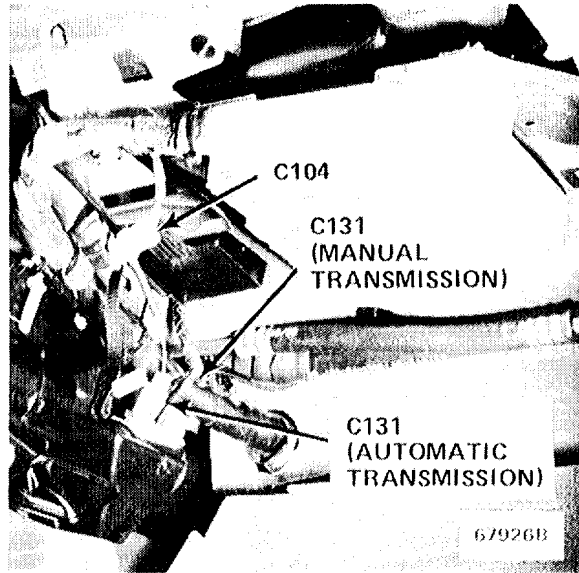

Figure 4 - Under RH Side of Dash

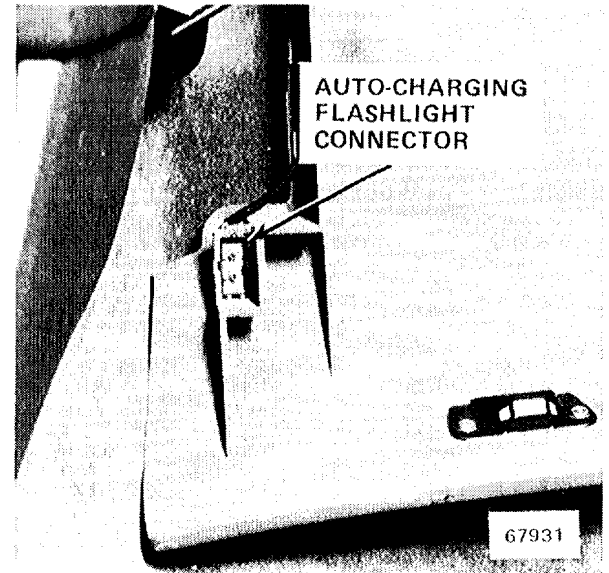

Figure 6 - Inside Glove Box

# 7000-8 COMPONENT LOCATION VIEWS

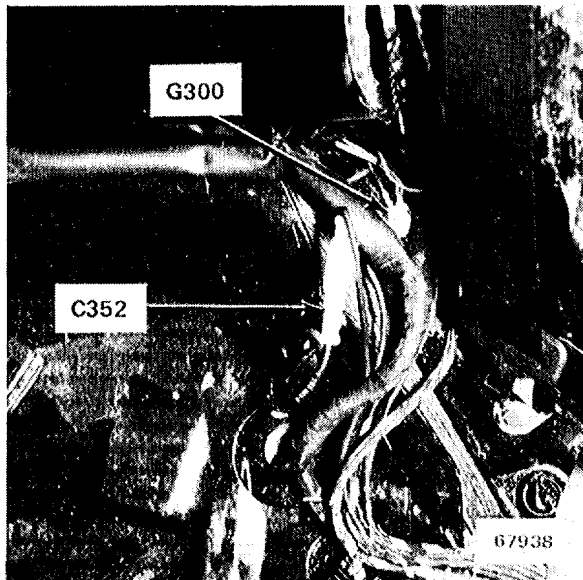

Figure 1 - Under LH Side of Rear Seat

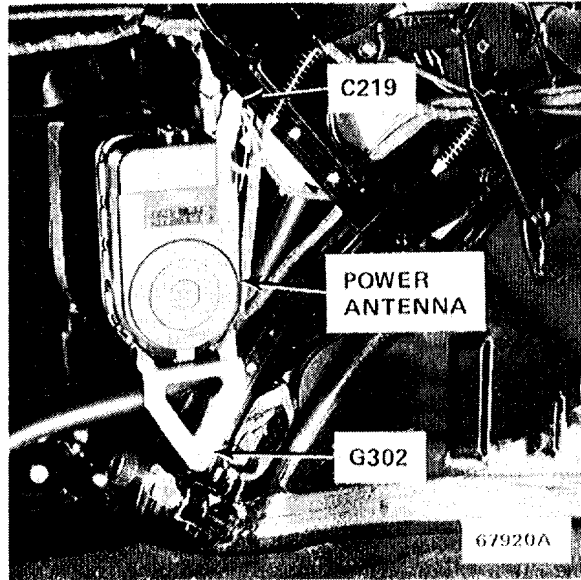

Figure 3 - LH Front of Trunk



Figure 5 - Middle Rear of Trunk

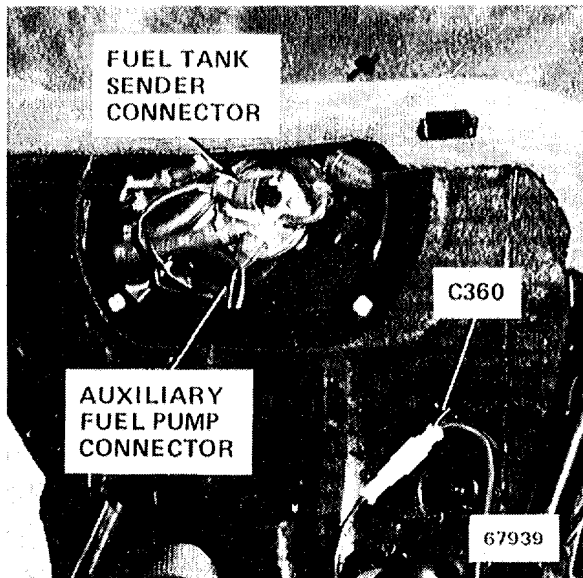

Figure 2 - Under RH Side of Rear Seat

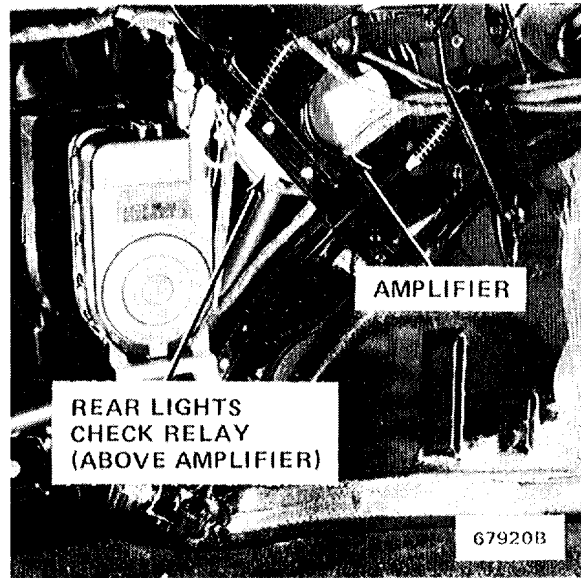

Figure 4 - LH Front of Trunk

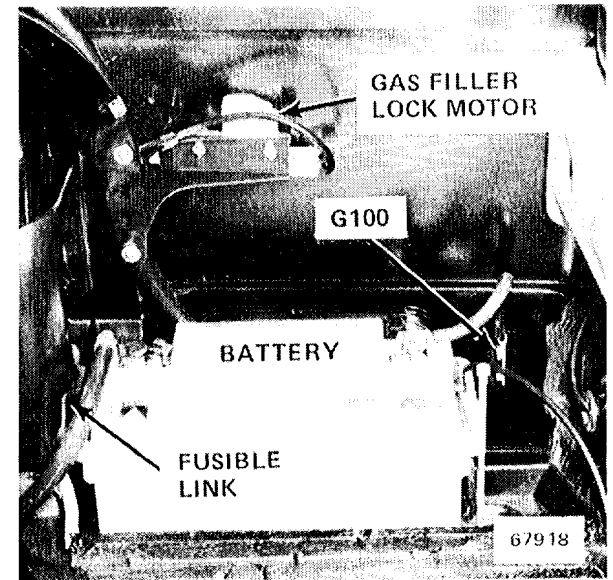

Figure 6 - RH Rear of Trunk

## 8000-0 SPLICE LOCATION VIEWS

### INDEX

This index contains all the splices in the car, what harness each one is in, and the page that the splices appear on. The drawings after the index show how the harness is routed through the car and where the splices are located on the harness.

SPLICE	HARNESS	PAGE NUMBER	SPLICE	HARNESS	PAGE NUMBER	SPLICE	HARNESS	PAGE NUMBER
S100	MAIN	8000-1	S220	I/P	8000-5	S502	LH FRONT	
S101	MAIN	8000-1	S221	I/P	8000-5		DOOR	8000-3
S102	MAIN	8000-1	S225	MULTI		S503	LH FRONT	
S103	MAIN	8000-1		FUNCTION			DOOR	8000-3
S104	ENGINE	8000-2		CLOCK	NOT SHOWN	S504	LH FRONT	
S105	ENGINE	8000-2	S300	DOOR	8000-3		DOOR	8000-3
S106	ENGINE	8000-2	S301	DOOR	8000-3	S600	SUNROOF	NOT
S107	ENGINE	8000-2	S302	DOOR	8000-3			SHOWN
S108	ENGINE	8000-2	S303	DOOR	8000-3	S601	SUNROOF	NOT
S110	ENGINE	8000-2	S305	DOOR	8000-3			SHOWN
S112	ENGINE	8000-2	S306	I/P	8000-5			
S114	MAIN	8000-1	S307	I/P	8000-5			
S115	MAIN	8000-1	S308	DOOR	8000-3			
S116	MAIN	8000-1	S309	DOOR	8000-3			
S117	ABS	NOT	S310	MAIN	8000-1			
		SHOWN	S311	I/P	8000-5			
S118	ABS	NOT	S312	MAIN	8000-1			
		SHOWN	S313	MAIN	8000-1			
S119	ABS	NOT	S316	MAIN	8000-1			
		SHOWN	S319	MAIN	8000-1			
S120	ABS	NOT	S322	DOOR				
		SHOWN		(4 DR ONLY)	8000-3			
S200	MAIN	8000-1	S323	DOOR	8000-3			
S201	COMPUTER	8000-4	S324	MAIN	8000-1			
S202	COMPUTER	8000-4	S325	MAIN	8000-1			
S203	MAIN	8000-1	S326	MAIN	8000-1			
S207	MAIN	8000-1	S328	MAIN	8000-1			
S209	MAIN	8000-1	S329	MAIN	8000-1			
S210	MAIN	8000-1	S330	MAIN	8000-1			
S211	MAIN	8000-1	S332	DOOR	8000-3			
S212	MAIN	8000-1	S333	DOOR	8000-3			
S213	MAIN	8000-1	S340	MAIN	8000-1			
S214	ENGINE	8000-2	S402	DOOR				
S215	MAIN	8000-1		(4 DR ONLY)	8000-3			
S216	ENGINE	8000-2	S411	RH FRONT				
S217	ENGINE	8000-2		DOOR	8000-3			
S218	I/P	8000-5	S501	LH FRONT				
S219	I/P	8000-5		DOOR	8000-3			

MAIN HARNESS SPLICE LOCATIONS

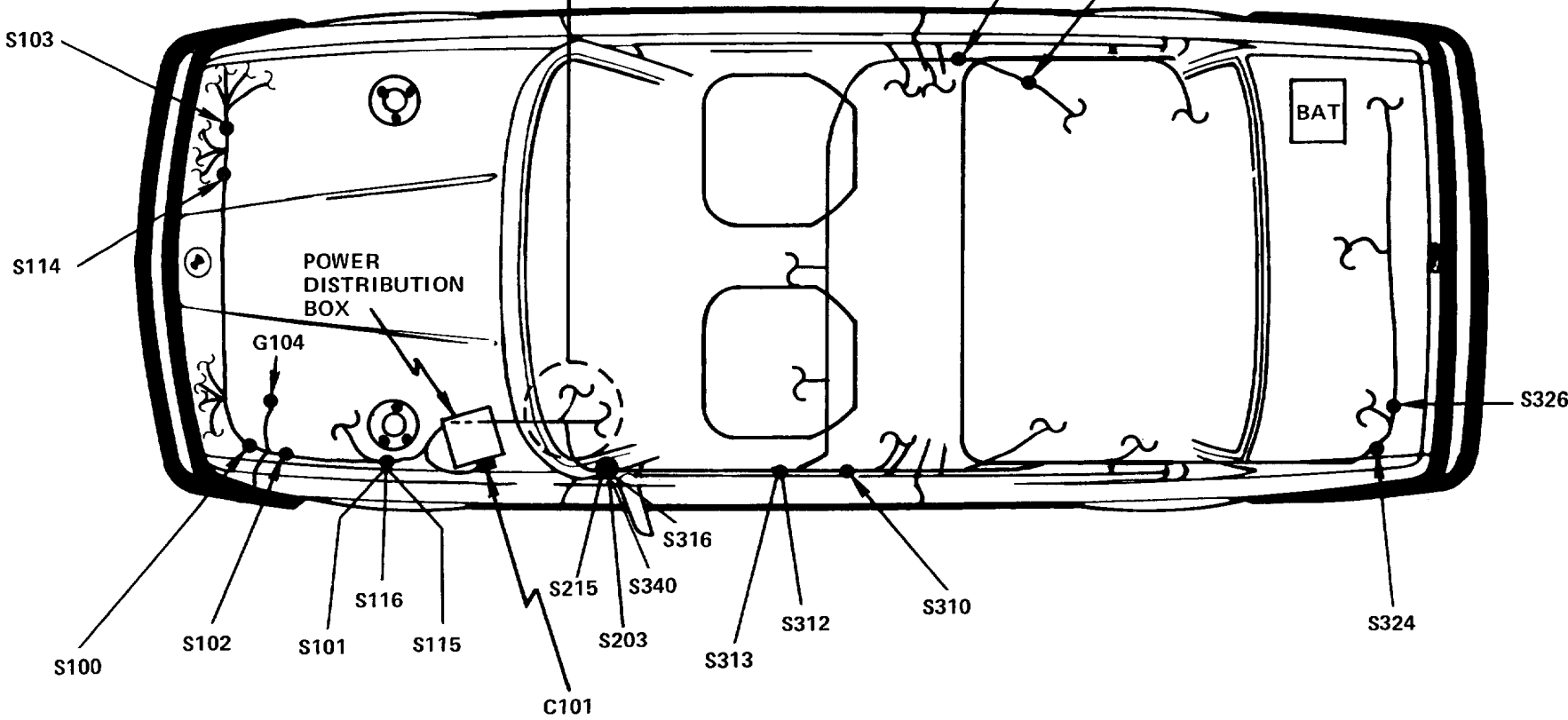
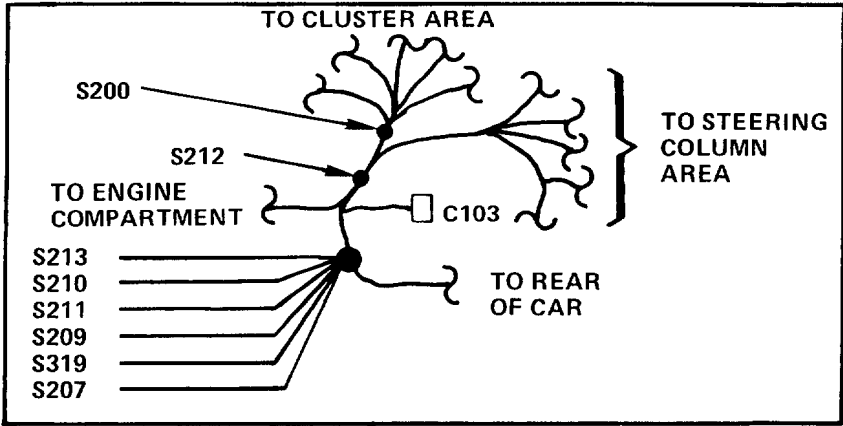

# 8000-2 SPLICE LOCATION VIEWS

## ENGINE HARNESS SPLICE LOCATIONS

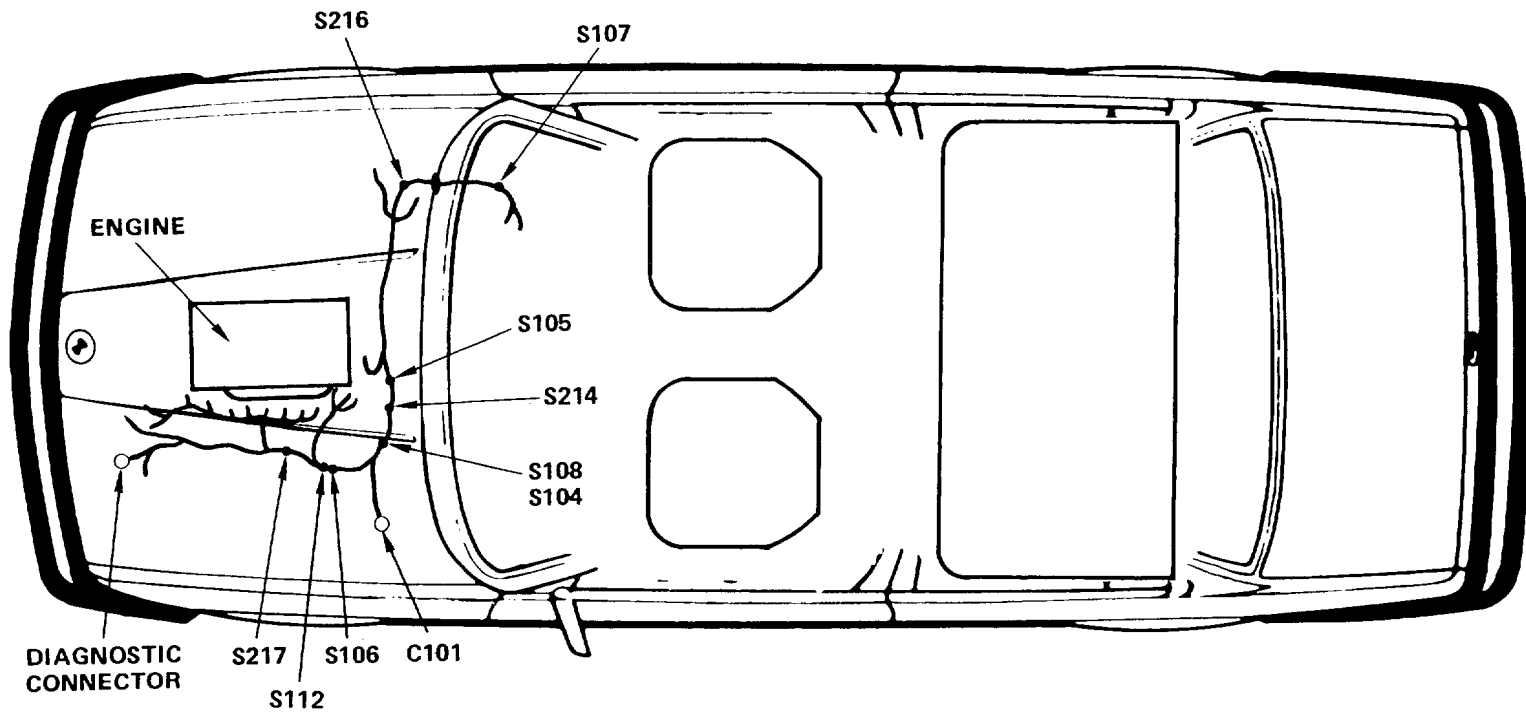

DOOR HARNESS SPLICE LOCATIONS

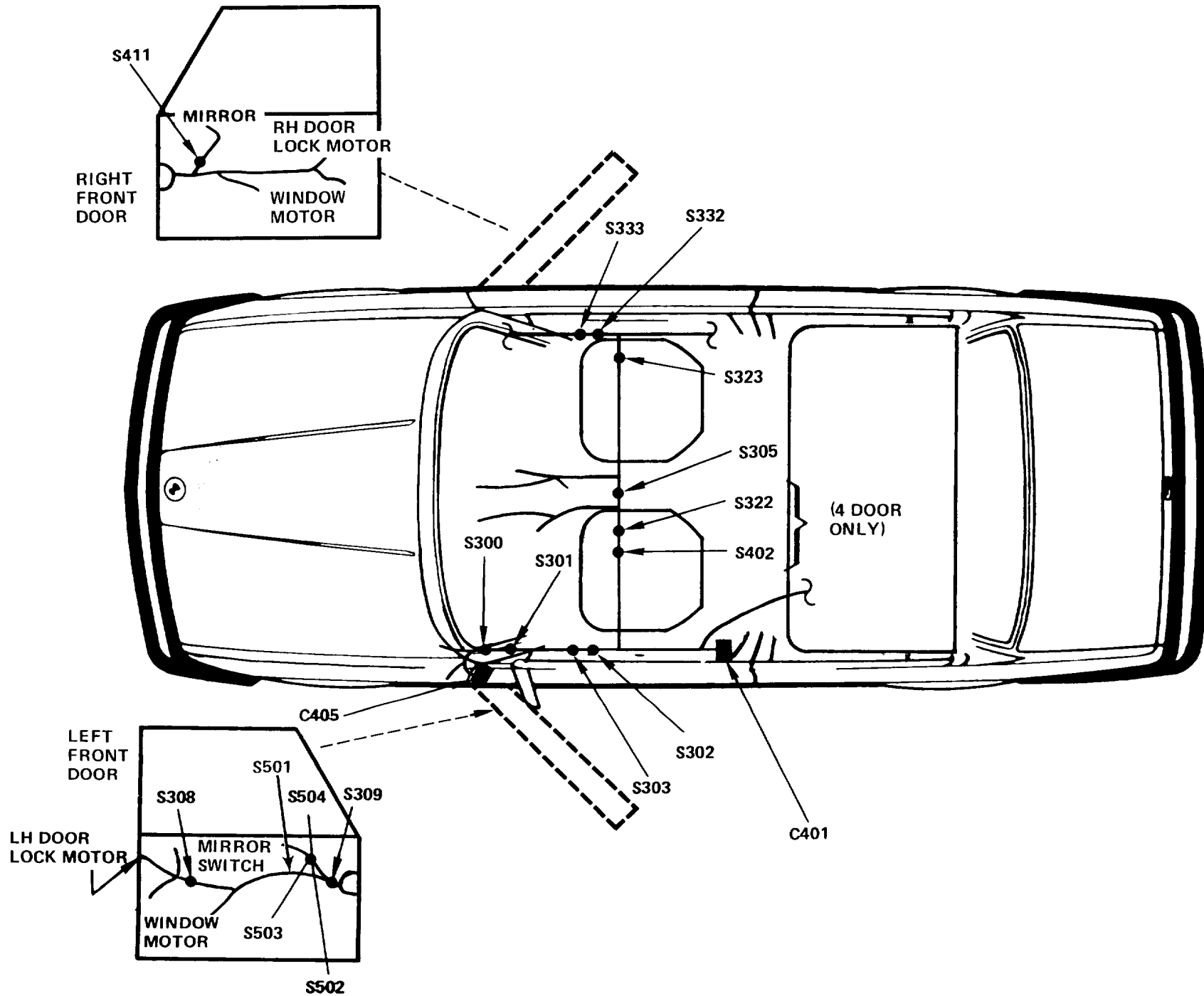

# 8000-4 SPLICE LOCATION VIEWS

## ON-BOARD COMPUTER HARNESS SPLICE LOCATIONS

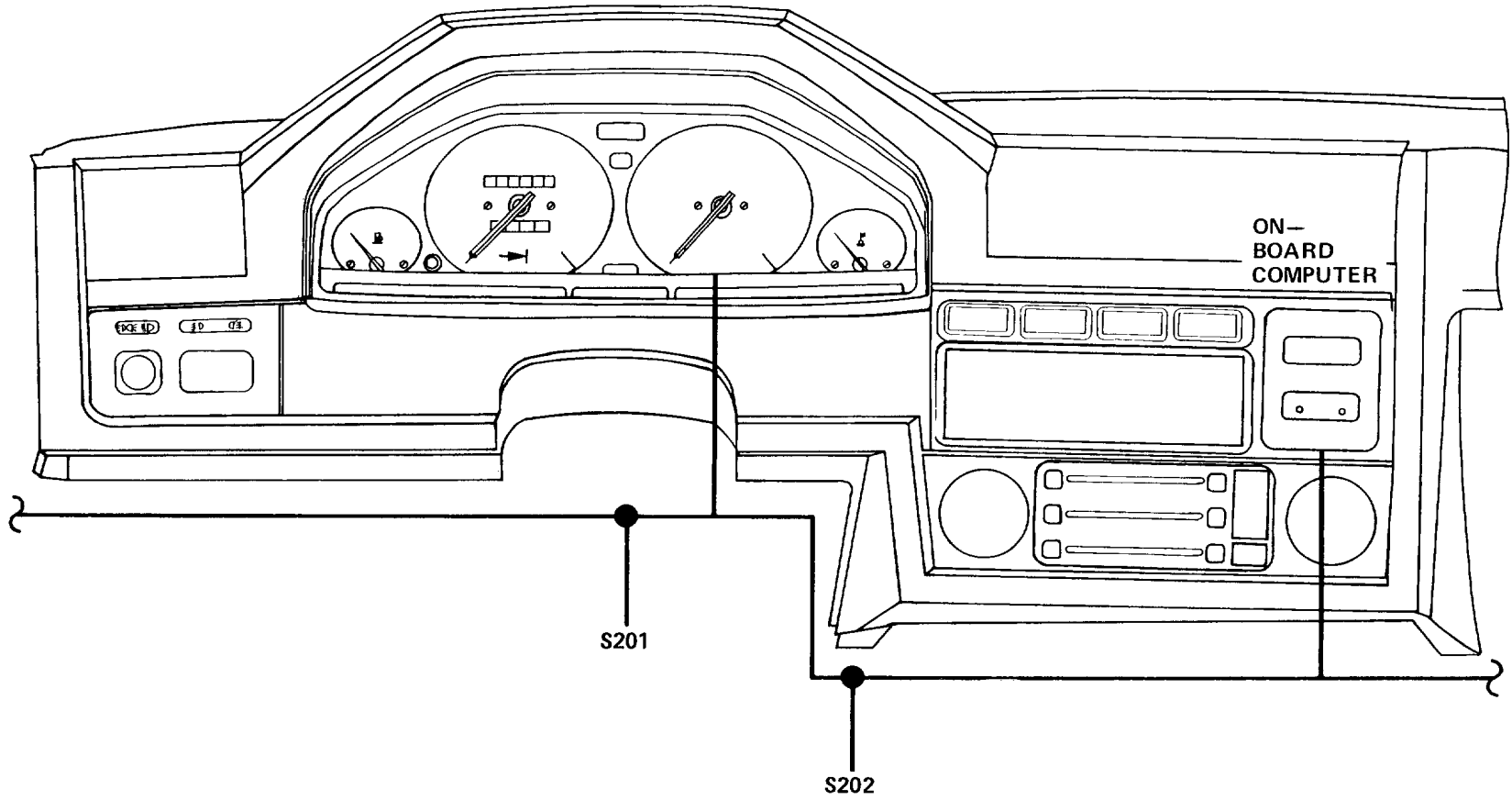

INSTRUMENT PANEL HARNESS SPLICE LOCATIONS

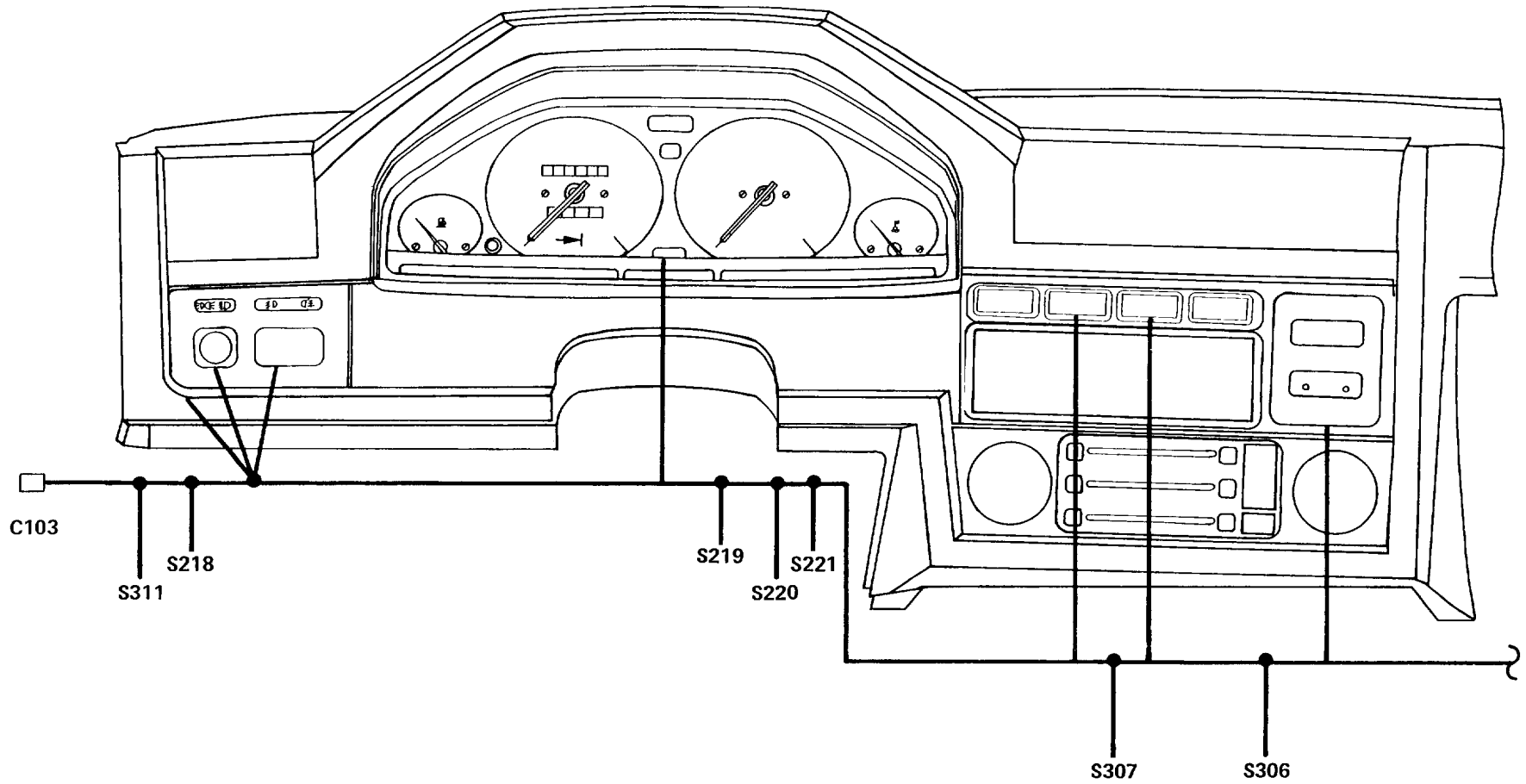



# 8500-0 CONNECTOR VIEWS

## DIAGNOSTIC CONNECTOR

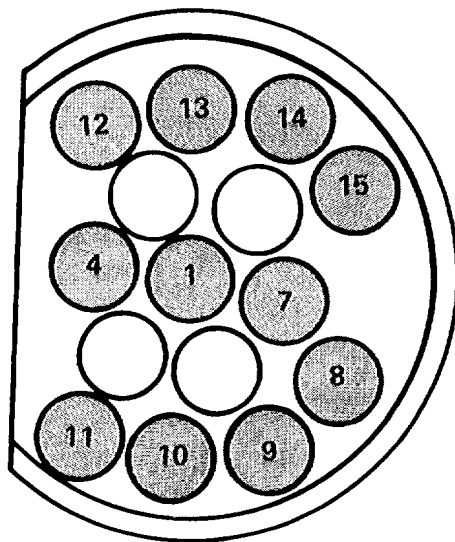

DIAGNOSTIC CONNECTOR FACE

PIN	WIRE SIZE	WIRE COLOR	CIRCUIT AND COMPONENT CONNECTED
1	1.5	BR	Ground Distribution, G103
4	.5	BR/VI	Gauges/Warning Indicators, Coolant Temperature Sender
6	.75	GY/BU	Idle Speed Control Unit
7	.5	WT/BU	Service Interval Indicator, Service Interval Processor (Reset)
8	.5	YL	Ignition, TDC Sensor.
9		SHIELD	Ignition, TDC Sensor.
10	.5	BK	Ignition, TDC Sensor.
11	2.5	BK/YL	Start, Start Signal. (50)
12	.75	BU	Charge System, Alternator (D+)
13	1	GN	Ignition, Ignition Coil
14	2.5	RD	Charge System, Alternator (30)
15	1.5	GN/YL	Idle Speed Control, Idle Speed Control Unit.

## ACCESSORY CONNECTOR

## CIRCUITS USING C301 (ACCESSORY CONNECTOR)

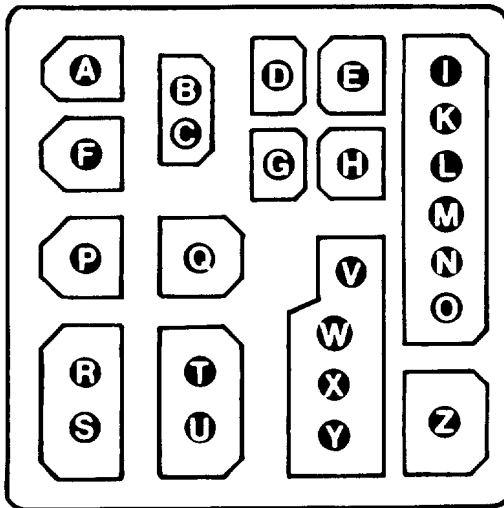
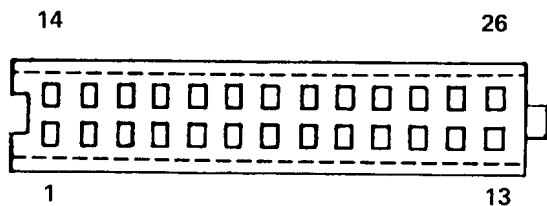

Figure 1-C302 (Accessory Connector)  
Front View—Under LH Side  
of Dash Ahead of Pedal Assembly

TERMINAL	CIRCUIT	TERMINAL	CIRCUIT
A	Not Used	N	Not Used
B	Not Used	O	Not Used
C	Anti-Lock Braking	P	Not Used
D	Anti-Lock Braking	Q	Power Windows & Sunroof
E	Not Used	R	Cruise Control
F	Not Used	S	Anti-Lock Braking
G	Anti-Lock Braking	T	Not Used
H	On-Board Computer	U	Not Used
I	Not Used	V	Radio
J	Not Used	W	Not Used
K	Not Used	X	Radio
L	Not Used	Y	Radio
M	Not Used	Z	Power Antenna

# 8500-2 CONNECTOR VIEWS



Wiring Face  
ACTIVE CHECK CONTROL

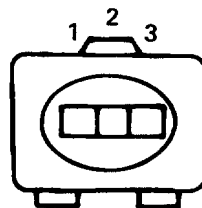

Wiring Face  
BAROMETRIC PRESSURE SENSOR

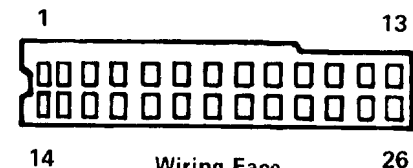

Wiring Face  
CRUISE CONTROL

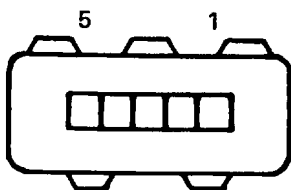

Mating Face  
AIR FLOW METER

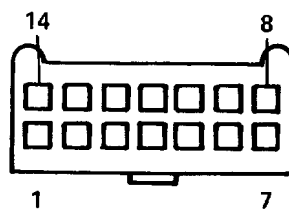

Wiring Face  
CENTRAL LOCKING CONTROL UNIT

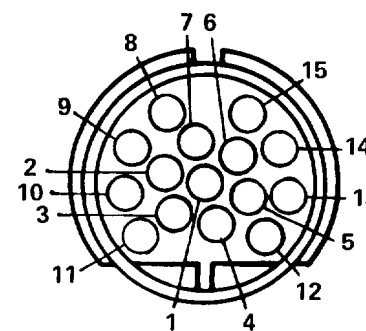

Mating Face  
DIAGNOSTIC CONNECTOR

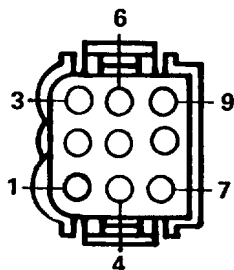

Wiring Face  
AUTOMATIC TRANSMISSION RANGE SWITCH



Wiring Face  
CHIME MODULE (C1)

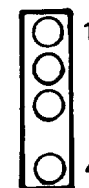

Wiring Face  
DIGITAL CLOCK

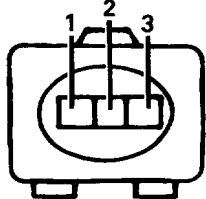

Wiring Face  
ENGINE SPEED SENSOR

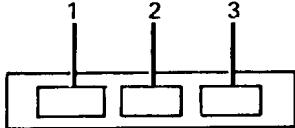

Wiring Face  
FRONT TURN/PARK LIGHT

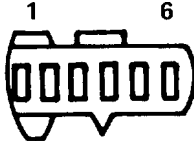

Wiring Face  
GAS FILLER LOCK MOTOR

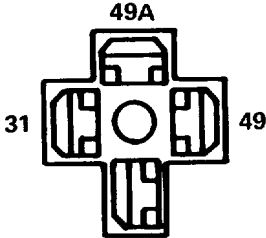

Wiring Face  
FLASHER

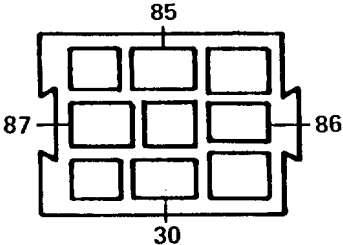

Wiring Face  
FUEL PUMP RELAY

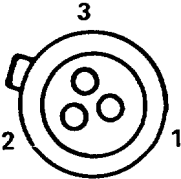

Wiring Face  
HEATED OXYGEN GENERATOR SENSOR

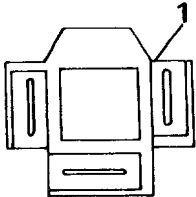

Wiring Face  
FRONT HEADLIGHTS

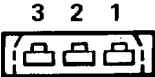

Wiring Face  
FUEL TANK SENDER

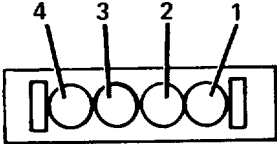

Wiring Face  
HIGH LEVEL STOP LIGHT

# 8500-4 CONNECTOR VIEWS

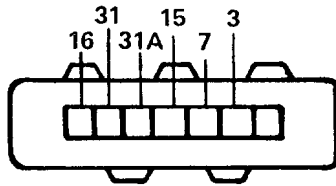

Mating Face  
**IGNITION CONTROL MODULE**  
(318 EARLY PRODUCTION)

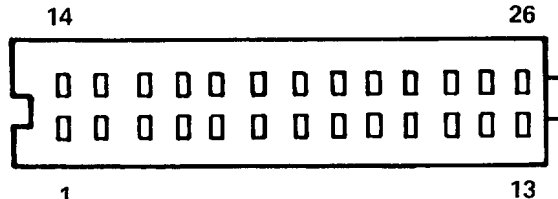

Wiring Face  
**INSTRUMENT CLUSTER (C2)**

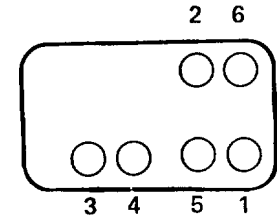

Mating Face  
**MIRROR CONTROL SWITCH**

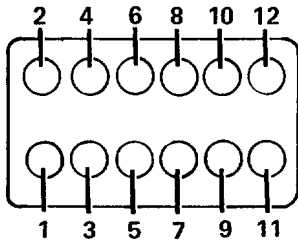

Wiring Face  
**IDLE AIR CONTROL**

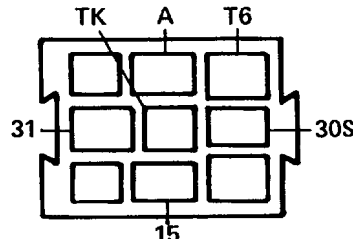

Wiring Face  
**INTERIOR LIGHT TIMER CONTROL**

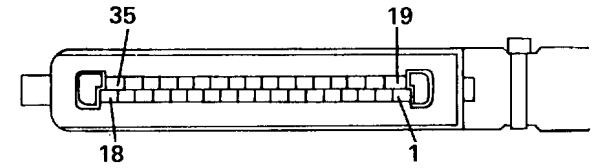

Mating Face  
**MOTRONIC CONTROL UNIT**

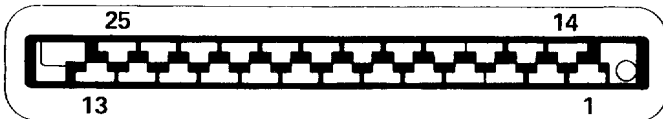

Mating Face  
**INJECTION CONTROL MODULE**

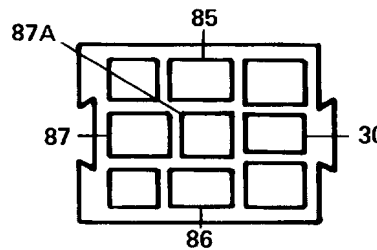

Wiring Face  
**MAIN RELAY**

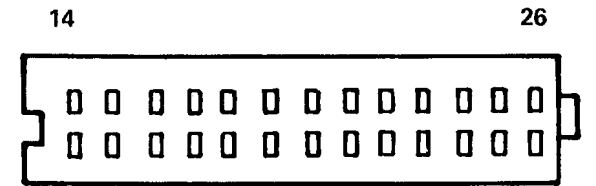

Wiring Face  
**ON-BOARD COMPUTER MODULE**

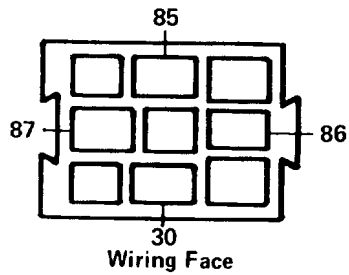

Wiring Face  
OXYGEN SENSOR HEATER RELAY

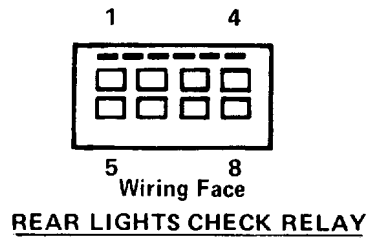

Wiring Face  
REAR LIGHTS CHECK RELAY

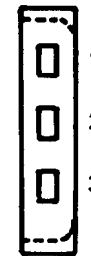

Wiring Face  
SUNROOF MOTOR (CI)

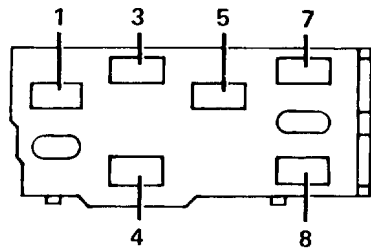

Wiring Face  
POWER WINDOW SWITCHES

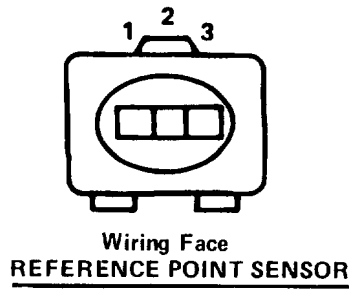

Wiring Face  
REFERENCE POINT SENSOR

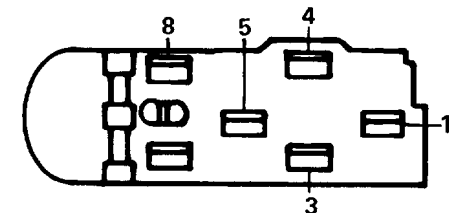

Wiring Face  
SUNROOF SWITCH

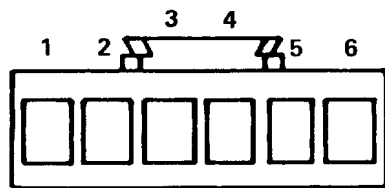

Wiring Face  
REAR LIGHT ASSEMBLY

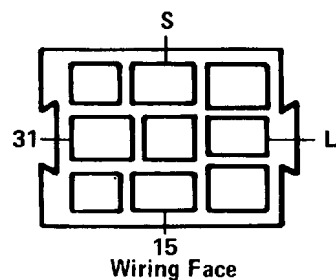

Wiring Face  
SEAT BELT WARNING TIMER

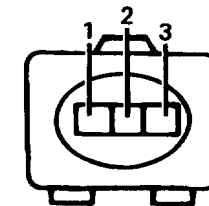

Wiring Face  
THROTTLE POSITION SENSOR

# 8500-6 CONNECTOR VIEWS

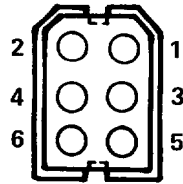

Wiring Face  
WIPER MOTOR

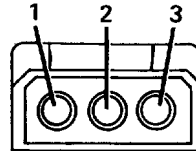

Wiring Face  
C104

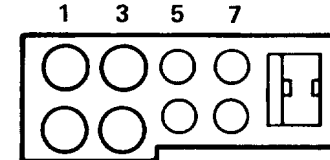

Wiring Face  
C200

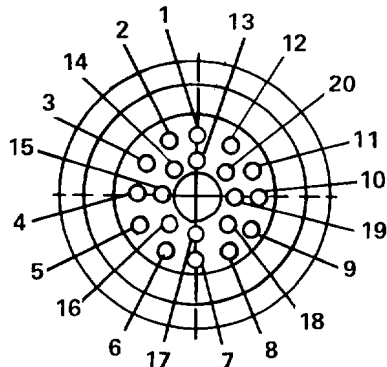

Wiring Face  
C101

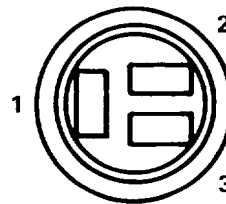

Wiring Face  
C113



Wiring Face  
C201

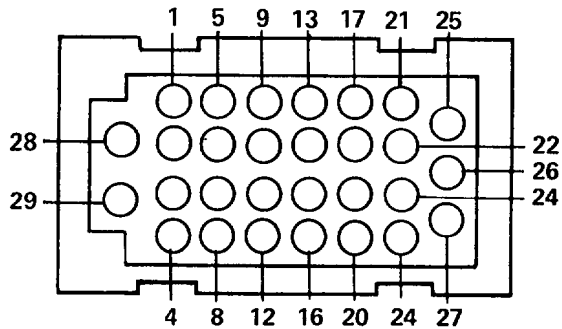

Wiring Face  
C103



Wiring Face  
C114

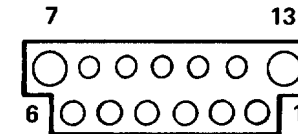

Wiring Face  
C202

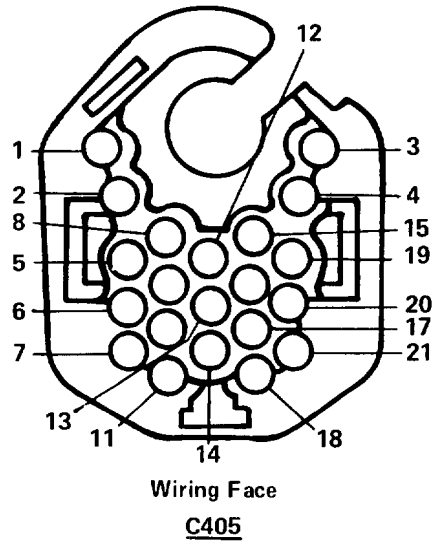
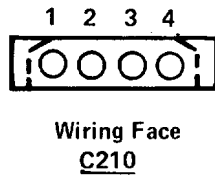
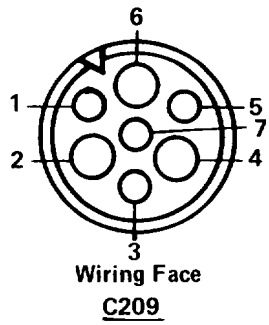
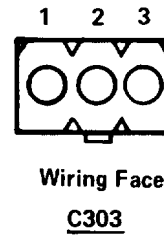
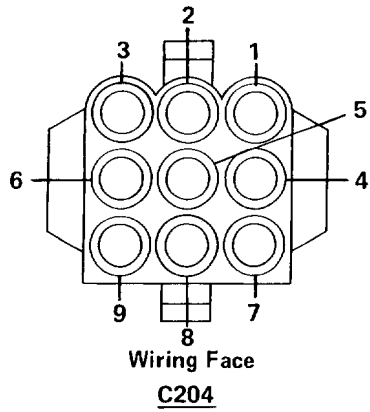



## 9000-0 COMPONENT LOCATION CHART

COMPONENTS		Page-Figure
A/C In-Line Diode . . . . .	Left side of evaporator housing . . . . .	7000-6-2
A/C In-Line Fuse . . . . .	Left side of evaporator housing . . . . .	7000-6-2
ABS Electronic Control Unit . . .	Under LH side of dash, above hood release. . . . .	7000-5-2
ABS Hydraulic Unit . . . . .	In front of left front wheel well . . . . .	7000-1-2
Active Check Control Unit . . . .	Above rear view mirror . . . . .	7000-6-6
Air Flow Meter . . . . .	Behind air cleaner . . . . .	7000-0-6
Amplifier . . . . .	In trunk, above left wheel well . . . . .	7000-8-4
Auto-Charging Flashlight . . . . .	In glove box . . . . .	7000-7-6
Automatic Trans. Range Switch . . . . .	At base of shift lever . . . . .	7000-7-1
Auxiliary Fan . . . . .	In front of A/C condenser . . . . .	7000-4-2
Auxiliary Fan Normal Speed Blower Resistor . . . . .	Front of A/C condenser . . . . .	7000-4-2
Auxiliary Fuel Pump . . . . .	In fuel tank. . . . .	7000-8-2
Auxiliary Fuse . . . . .	On top of LH front shock tower . . . . .	7000-0-2
B/C Horn Diode . . . . .	Near LH front shock tower . . . . .	7000-0-1
Backup Light Switch . . . . .	On transmission	
Barometric Pressure Sensor . . .	Mounted on air intake housing . . . . .	7000-1-5
Battery . . . . .	In RH rear of trunk . . . . .	7000-8-6
Battery Junction Block . . . . .	Engine compartment, at RH bulkhead . . . . .	7000-3-4
Blower Motor . . . . .	Behind center console, in evaporator housing	
Blower Resistors . . . . .	Behind center console, in evaporator housing	
Board Computer Horn . . . . .	Near LH front shock tower . . . . .	7000-0-1
Brake Fluid Level Switch . . . . .	Left of engine, on brake fluid reservoir. . . . .	7000-0-2
Brake Switch . . . . .	On brake pedal support, above brake pedal . . . . .	7000-5-5
Brake Wear Sensors . . . . .	On LH front and RH rear brake calipers . . . . .	7000-3-5
Central Lock Control Unit . . . . .	Below and behind left front speaker . . . . .	7000-5-1
Chime Module . . . . .	Mounted on LH dash hush panel. . . . .	7000-5-6
Clutch Diode . . . . .	Lower RH front of engine, on compressor . . . . .	7000-2-3
Clutch Switch . . . . .	Above clutch pedal	
Cold Start Valve . . . . .	Top RH side of intake manifold. . . . .	7000-3-2
Combination Switch . . . . .	Upper left side of steering column	
Compressor Clutch . . . . .	Lower RH front of engine, on compressor . . . . .	7000-2-3
Compressor Enable Switch . . . .	Behind A/C face plate	
Coolant Level Switch . . . . .	On RH front wheel well, in coolant reservoir. . . . .	7000-3-3
Coolant Temperature Sender . . .	Front of engine, top of thermostat housing. . . . .	7000-1-6
Coolant Temperature Sensor . . .	Front of engine, top of thermostat housing. . . . .	7000-1-6
Coolant Temperature Switch . . .	Front of engine, top of thermostat housing. . . . .	7000-1-5
Cruise Control Actuator . . . . .	Forward of LH front shock tower . . . . .	7000-1-1
Cruise Control Control Unit . . .	Mounted under RH side of dash . . . . .	7000-7-5
Cruise Control Switch . . . . .	On RH side of steering column	
Diagnostic Connector . . . . .	Top LH front of engine . . . . .	7000-1-4
Door Lock Motors . . . . .	Rear part of each door	

		Page-Figure
Engine Speed Sensor . . . . .	Lower LH side of transmission bell housing . . . . .	7000-0-3
Evaporator Temperature Switch . . . . .	LH side of evaporator housing . . . . .	7000-6-3
Flasher . . . . .	Upper part of steering column . . . . .	7000-6-4
Fresh/Recirculating Air Flap Door Motors . . . . .	Behind A/C face plate. . . . .	7000-7-3
Fresh/Recirculating Air Relays . .	Behind A/C face plate	
Fuel Injectors . . . . .	Below intake manifold, at each port . . . . .	7000-1-6
Fuel Pump Relay . . . . .	On bracket, in front of LH front shock tower. . . . .	7000-0-5
Fuel Tank Sender . . . . .	Top of fuel tank. . . . .	7000-8-2
Fusible Link . . . . .	In trunk, connected to positive battery terminal. . . . .	7000-8-6
Gas Filler Lock Motor . . . . .	In trunk, behind RH wheel well . . . . .	7000-8-6
Hazard Switch . . . . .	In center console, above radio . . . . .	7000-6-5
High Pressure Cut-Out Switch	On receiver dryer, behind RH headlight . . . . .	7000-2-5
High Speed Coolant Temperature Switch . . . . .	Top LH side of radiator . . . . .	7000-2-1
Horn/Brush Slip Ring . . . . .	In upper steering column. . . . .	7000-6-4
Horns . . . . .	Near fog lights, behind splash guard . . . . .	7000-4-1
Hot Water Cut-Off Switch . . . . .	Behind A/C face plate	
Idle Control Valve . . . . .	Top RH rear side of engine . . . . .	7000-3-2
Idle Speed Control Unit . . . . .	RH side of dash, above glove box . . . . .	7000-7-5
Ignition Coil . . . . .	On RH front wheel well . . . . .	7000-3-3
Ignition Key Switch . . . . .	Part of ignition switch, in upper part of steering column	
Ignition Switch . . . . .	Upper part of steering column	
Interior Light Timer Control . . . . .	Below LH front speaker . . . . .	7000-5-1
Lock Inhibit Switch . . . . .	Rear of RH front door	
Low Pressure Cut-Out Switch . . . . .	Behind RH headlights . . . . .	7000-2-5
Main Fuel Pump . . . . .	Under car, in front of left rear wheel . . . . .	7000-4-5
Main Relay . . . . .	Behind header, above rear view mirror . . . . .	7000-6-6
Motor Relay . . . . .	On bracket, in front of left front shock tower . . . . .	7000-0-5
Motronic Control Unit . . . . .	Under RH side of dash, above glove box . . . . .	7000-7-5
Normal Speed Coolant Temperature Switch . . . . .	Top LH side of radiator . . . . .	7000-2-1
Oil Level Sensor . . . . .	Top LH side of oil pan . . . . .	7000-1-3
Oil Pressure Switch . . . . .	Below oil filter . . . . .	7000-2-4
On-Board Computer Module . . . . .	In center console, RH of radio. . . . .	7000-6-5
On-Board Computer Relay Box	Under LH side of dash, above hood release. . . . .	7000-5-5
Outside Temperature Sensor. . . . .	Behind splash guard, near LH fog light . . . . .	7000-4-1
Over Voltage Protection Relay. . . . .	Under LH side of dash, near ABS electronic control unit. . . . .	7000-5-2

## 9000-2 COMPONENT LOCATION CHART

		Page-Figure
Oxygen Sensor . . . . .	In front of catalytic converter, on top of exhaust pipe . . . . .	7000-4-3
Oxygen Sensor Heater Relay . . . . .	On bracket, in front of left front shock tower . . . . .	7000-0-5
Park Brake Switch . . . . .	At base of parking brake . . . . .	7000-7-2
Power Antenna . . . . .	In trunk, behind LH wheel well . . . . .	7000-8-3
Power Distribution Box . . . . .	At top rear of left front wheel well . . . . .	7000-0-1
Power Window Circuit Breaker . . . . .	On center console, above radio . . . . .	7000-6-5
Power Window Motors . . . . .	Forward part of each door . . . . .	7000-4-6
Pulse Wheels . . . . .	On wheel, in brake housing	
Rear Lights Check Relay . . . . .	In trunk, above left wheel well . . . . .	7000-8-4
Rear Window Safety Switch . . . . .	On center console, left of shift lever . . . . .	7000-7-1
Reference Point Sensor . . . . .	Lower LH side of transmission bell housing . . . . .	7000-0-3
Safety Switch . . . . .	On top of LH wheel well, near cruise control actuator . . . . .	7000-1-1
Seatbelt Switch . . . . .	In driver's seatbelt buckle	
Seatbelt Warning Timer . . . . .	Under LH side of dash, on electrical bracket . . . . .	7000-5-6
Speed Detectors . . . . .	On wheel, in brake housing . . . . .	7000-3-6
Speedometer Sender . . . . .	In rear of differential . . . . .	7000-4-4
Start Relay . . . . .	Upper LH corner of driver's footwell . . . . .	7000-5-6
Starter . . . . .	Lower LH rear of engine	
Sunroof Motor . . . . .	In windshield header, above rear view mirror . . . . .	7000-6-6
TDC Sensor . . . . .	Front of engine, above crankshaft vibration dampener . . . . .	7000-2-2
Temperature Switch (0 Degrees C) . . . . .	On engine bulkhead, left of battery junction block . . . . .	7000-3-4
Thermo-Time Switch . . . . .	Top front of coolant thermostat housing . . . . .	7000-1-5
Throttle Switch . . . . .	Below rear of throttle body . . . . .	7000-0-4
Trunk Lock Motor . . . . .	On trunk lock center support . . . . .	7000-8-5
Unlock Inhibit Switch . . . . .	Rear of LH front door	
Washer Fluid Level Switch . . . . .	In reservoir, behind RH headlights . . . . .	7000-2-6
Washer Pump . . . . .	Ahead of right front wheel well, on reservoir . . . . .	7000-3-1
Water Shut-Off Solenoid . . . . .	Left side of evaporator housing . . . . .	7000-6-3
Wiper Motor . . . . .	Under left fresh air intake cowl	
Wiper/Washer Switch . . . . .	Upper right side of steering column	
<b>CONNECTORS</b>		
C 101 (20 pins) . . . . .	Next to power distribution box, mounted on engine dash . . . . .	7000-0-2
C 103 (29 pins) . . . . .	Behind LH side of dash, on body electrical bracket . . . . .	7000-5-4
C 104 (3 pins) . . . . .	Behind RH side of dash, above glove box . . . . .	7000-7-4
C 105 (1 pin) . . . . .	Right side of evaporator housing . . . . .	7000-7-3
C 106 (1 pin) . . . . .	Near washer pump . . . . .	7000-2-6
C 107 (1 pin) . . . . .	Near washer pump . . . . .	7000-3-1

		Page-Figure
C 109 (6 pins)	Near wiper motor	
C 113 (3 pins)	Behind LH headlights	7000-1-2
C 126 (2 pins)	Behind LH headlights	7000-2-5
C 127 (2 pins)	Behind RH headlights	7000-2-5
C 131 (1 pin) (With Automatic Transmission)	Behind RH side of dash, above glove box	7000-7-4
C 131 (1 pin) (With Manual Transmission)	RH side of dash, above glove box	7000-7-4
C 132 (1 pin)	In console, near automatic transmission range switch	7000-7-1
C 140 (3 pins)	Near RH rear side of engine	7000-3-3
C 141 (3 pins)	Under RH side of car, below passenger side	7000-4-3
C 142 (1 pin)	Under LH side of dash, above steering column	7000-6-1
C 143 (1 pin)	Under LH side of dash, near body electrical bracket	7000-5-6
C 150 (2 pins)	On top of LH front wheel well	7000-0-6
C 151 (2 pins)	On top of RH front wheel well	7000-3-1
C 200 (9 pins)	Under LH side of dash, on steering column	7000-6-1
C 201 (6 pins)	Under LH side of dash, on steering column	7000-6-1
C 202 (13 pins)	Under LH side of dash, on steering column	7000-6-1
C 204 (9 pins)	Under LH side of dash, near steering column	7000-6-2
C 208 (2 pins)	Near brake pedal support bracket	7000-5-6
C 209 (7 pins)	Above brake pedal	7000-5-3
C 210 (4 pins)	On LH side of steering column	7000-6-1
C 212 (2 pins)	Under LH side of dash, near accessory connector	7000-5-3
C 215 (2 pins)	Center console, behind radio	7000-6-5
C 217 (1 pin)	Under LH side of dash, near accessory connector	7000-5-4
C 219 (2 pins)	In trunk, above and below LH wheel well	7000-8-3
C 224 (2 pins)	Under LH side of dash, near accessory connector	7000-5-3
C 235 (3 pins)	Under RH side of dash, near cruise control control unit	7000-7-3
C 240 (6 pins)	Under LH side of dash, above body electrical bracket	7000-5-3
C 241 (1 pin)	Under LH side of dash, above steering column	7000-6-1
C 251 (4 pins)	Behind A/C face plate	
C 260 (2 pins)	Near chime module	
C 301 (2 pins)	At base of shift lever	7000-7-1
C 302 (25 pins) Accessory Connector	Upper LH corner of driver's footwell	7000-5-4
C 303 (3 pins)	At base of right "B" pillar	
C 304 (3 pins)	At base of left "B" pillar	
C 305 (1 pin)	Under LH side of dash, near accessory connector	7000-5-3
C 351 (1 pin)	Under LH side of dash, near accessory connector	7000-5-3
C 352 (2 pins)	Behind LH side of rear seat	7000-8-1

## 9000-4 COMPONENT LOCATION CHART

---

		Page-Figure
C401 (7 pins)	In left "B" pillar	
C402 (7 pins)	In right "B" pillar	
C404 (21 pins)	Above RH front door jamb switch	
C405 (21 pins)	Above LH front door jamb switch	
C406 (1 pin)	In RH door	
C407 (1 pin)	In LH door	
C503 (3 pins)	In rear of LH front door	
C510 (1 pin)	Behind and above LH front speaker	7000-5-1
<b>GROUNDS</b>		
G100	RH rear of trunk, behind battery	7000-8-6
G103	On LH front of engine, under diagnostic connector	7000-1-4
G104	On inner fender, behind LH headlights	7000-1-1
G200	Under LH side of dash, above brake pedal	7000-5-5
G201 (Steering Column Ground)	Upper LH side of steering column	7000-6-4
G300	Behind LH side of rear seat	7000-8-1
G302	In trunk, behind left wheel well	7000-8-3
G600	In windshield header	

---